

Owner's Manual

DB-045BS1 Bolt-On Drawbar

Installation, Operation and Maintenance Procedures

- For on/off-road applications
- Weight: (approx.) 23 lbs. (10.4 kg)



For Load Ratings, Refer to Section 3

Contents	Page
Introduction.....	2
Warranty.....	2
Notes, Cautions, and Warnings.....	2
Section 1 – General Safety Instructions	3
Exploded View and Parts List.....	4
Section 2 – Drawbar Eye Dimensions.....	5
Section 3 – Load Ratings.....	6

Contents	Page
Section 4 – Towing Applications	6
Section 5 – General Information.....	6
Section 6 – General Safety Information	6
Section 7 – Mounting Instruction	7
Section 8 – Operating Instructions	9
Section 9 – Maintenance.....	10

Introduction

This manual provides information necessary for the proper operation, maintenance, and inspection of the SAF-HOLLAND® drawbar.

NOTE: For HOLLAND® replacement components contact SAF-HOLLAND® Customer Service: 1-888-396-6501.

Warranty

Refer to the complete warranty for the country in which the product will be used. A copy of the written warranty can be downloaded from our SAF-HOLLAND® website (www.safholland.com).

Notes, Cautions, and Warnings

Read and understand all of the procedures presented in this manual before starting any work on the pintle hook.

NOTE: In the United States, work shop safety requirements are defined by federal and/or state Occupational Safety and Health Act. Equivalent laws could exist in other countries. This manual is written based on the assumption that OSHA or other applicable employee safety regulations are followed by the location where work is performed.

Proper tools **MUST** be used to perform the mounting and maintenance procedures described in this manual.

This manual contains the terms “NOTE”, “IMPORTANT”, “CAUTION”, and “WARNING” followed by important product information. These terms are defined as follows:

NOTE: Includes additional information to enable accurate and easy performance of procedures.

IMPORTANT: Includes additional information that if NOT followed could lead to hindered product performance.

CAUTION Used without the safety alert symbol, indicates a potentially hazardous situation which, if not avoided, could result in property damage.

⚠ CAUTION Indicates a potentially hazardous situation which, if not avoided, could result in minor or moderate injury.

⚠ WARNING Indicates a potentially hazardous situation which, if not avoided, could result in death or serious injury.

1. General Safety Instructions

IMPORTANT: Read this manual before using this product. Keep this manual in a safe location for future reference.

⚠ WARNING Failure to follow the instructions and safety precautions in this manual can result in equipment failure which, if not avoided, could result in death or serious injury.

Read and observe all warning and caution hazard alert messages in this publication. The information provided can help prevent death, serious injury and/or damage to components.

NOTE: In this manual, all descriptions of orientation are relative to the vehicle.

Orientation

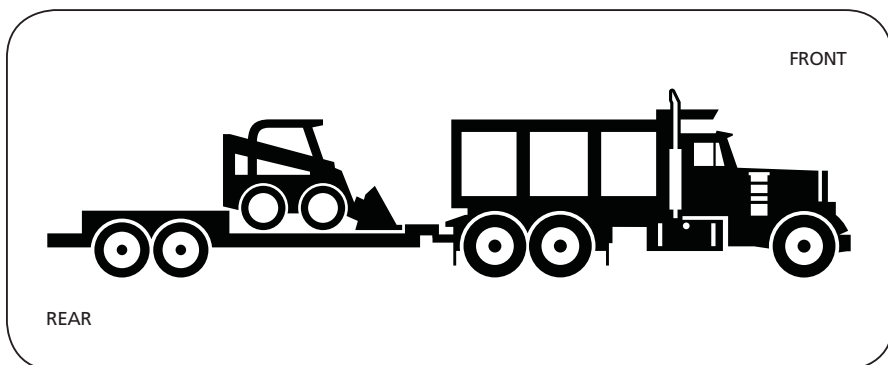

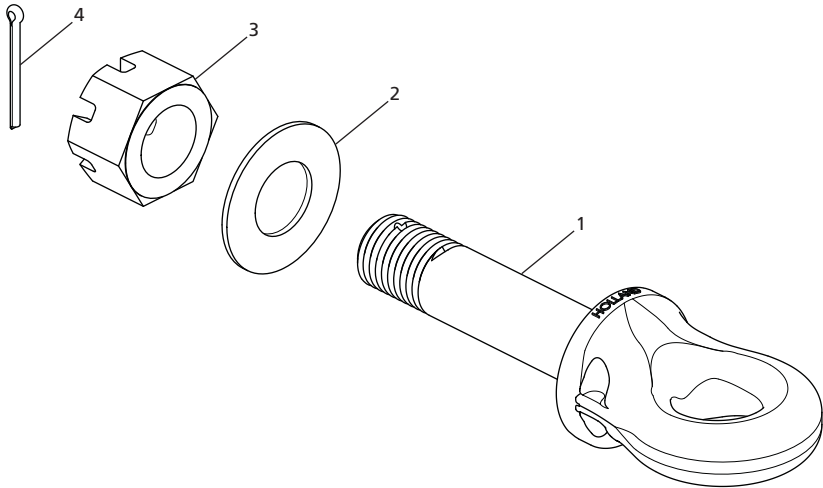

ITEM	DESCRIPTION	PART NUMBER	QTY.
1	Drawbar, 2-3/8" I.D.	XA-05833-A	1
2	Washer	XB-T-318	1
3	Nut, Heavy Hex Slotted 2" - 4/1/2"	XB-T-316-A	1
4	Pin, Cotter 1/4" x 3"	XB-121	1

2. Drawbar Eye Dimensions

2.38" (60.3 mm) I.D. with 1.63" (41.3 mm)
x 1.56" (39.6 mm) cross section.

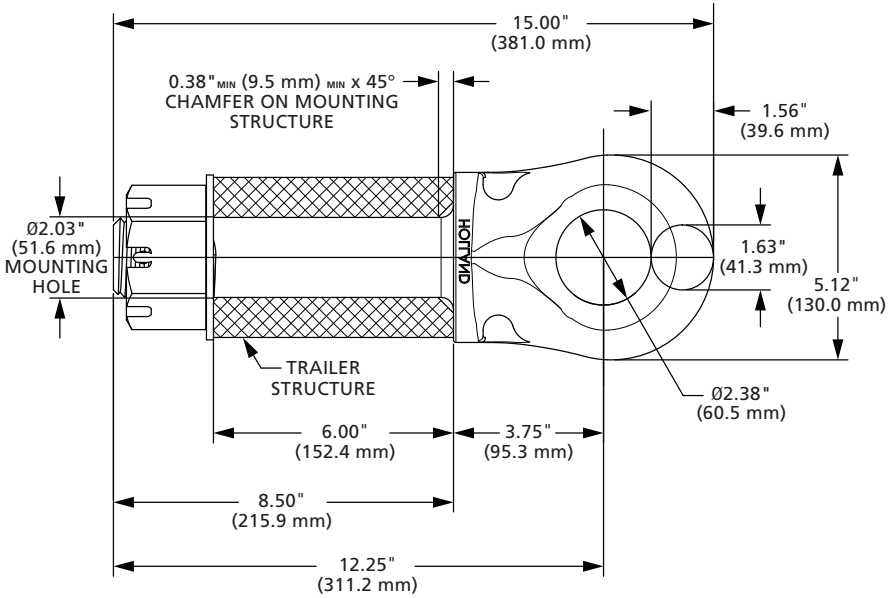

3. Load Ratings

Maximum GTW: 45,000 lb. (20,412 kg)

Maximum Vert. Load: 9,000 lb. (4,082 kg)

NOTE: When used for hinged tongue trailer applications
Max Vertical: 500 lb. (227 kg)
Max GTW: 85,000 lb. (38,555 kg)
This drawbar CANNOT be used as a swivel drawbar unless it is installed into a HOLLAND® approved structure, Refer to DB-045BW1.

4. Towing Applications

For general on/off road towing. For severe off-road applications, reduce the above capacities by 25%.

IMPORTANT: Off-road refers to terrain on which a tow/towed vehicle will operate that is ungraded, rough or undulating, with no maintained travel surface, generally considered to NOT be part of the public road system. Examples include agricultural fields, construction sites, utility right-of-way, temporary logging roads, and what is commonly referred to as 'two-track' roads.

5. General Information

1. DO NOT modify or add to the product.
2. This product is covered by SAF-HOLLAND'S® Commercial Warranty. SAF-HOLLAND® reserves the right, without giving prior notice, to change specifications and dimensions as designs are altered or improved.
3. Inspect the coupling device on the tow vehicle and trailer for proper operation. DO NOT use any coupling device that DOES NOT operate properly.
4. It is the responsibility of the user to become familiar with coupling and uncoupling procedures that are provided by various governments, industry associations and mating component manufacturers instructions.

6. General Safety Information

This equipment MUST NOT be used in a careless manner.

During Operation:

1. Maintain adequate vertical (tongue) load to properly control the towed unit (generally 10% of maximum GTW) but DO NOT exceed the rated capacities.
2. DO NOT damage the coupling components. Be particularly careful during coupling and uncoupling.
3. NEVER strike any part of the item with a steel hammer.

7. Mounting Instructions

1. Use a mounting structure of sufficient strength to support the rated capacity of the drawbar in accordance with SAE J849 and SAE J847 respectively.
2. Install the drawbar in compliance with all federal, state, or local agency regulations or laws governing the installation and use of the product. Consult with these agencies prior to installation or use.
3. Remove and retain the cotter pin (XB-121) (**Figure 1**).
4. Remove and retain the castle nut (XB-T-316-A) (**Figure 2**).
5. Remove and retain the washer (XB-T-318) (**Figure 3**).
6. Remove and retain the drawbar (XA-05833-A) (**Figure 4**).
7. Install drawbar to appropriate structure (**Figure 4**).

Figure 1

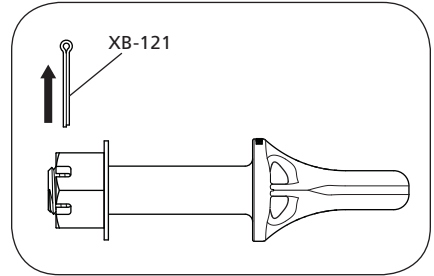

Figure 2

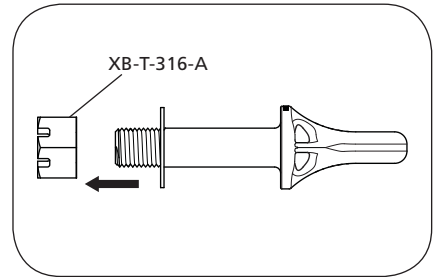

Figure 3

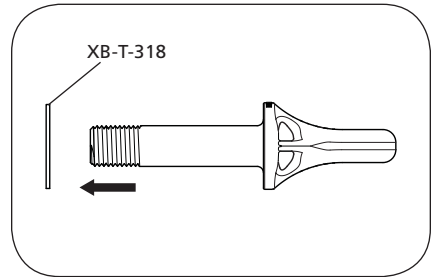
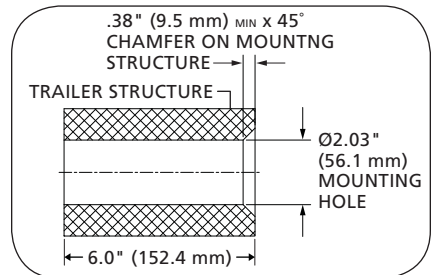

Figure 4



7. Install the drawbar (XA-05833-A) into the structure (**Figure 5**).
9. Install the washer (XB-T-318) (**Figure 6**).
10. Install the castle nut (XB-T-316-A) (**Figure 7**).

7.1 Fixed Drawbar Mount Castle Nut Torque:

Torque to a minimum of 550 ft-lbs. (746 N•m). Increase the torque an additional amount, if needed, to align the hole in the shank of the drawbar with the castle of the castle nut, (maximum additional rotation to be 1/6 of a full turn) (**Figure 8**).

7.2 Rotating Drawbar Mount Castle Nut Torque:

Using only a HOLLAND® approved structure (XA-610-30), torque to a minimum of 100 ft-lbs. (136 N•m). Increase the torque an additional amount, if needed, to align the hole in the shank of the drawbar with the castle of the castle nut, (maximum additional rotation to be 1/6 of a full turn) (**Figure 8**).

Figure 5

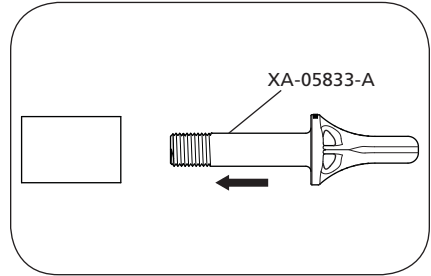

Figure 6

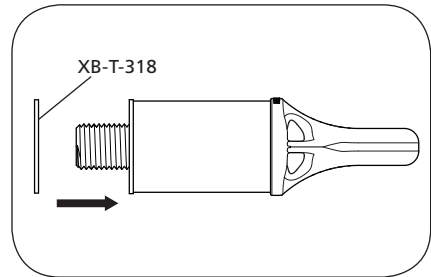

Figure 7

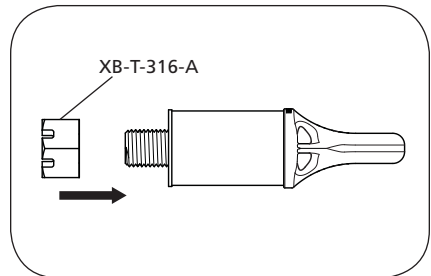
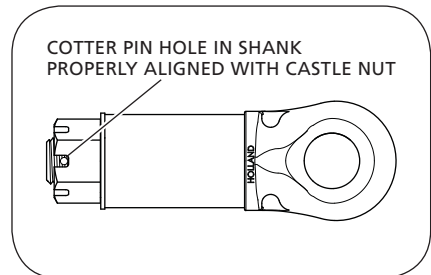

Figure 8



13. Install the cotter pin (XB-121) (**Figure 9**).
14. When the cotter pin is completely inserted, spread the ends of the cotter pin to lock into place.

8. Operating Instructions

1. Before operating, inspect for wear, damaged, or missing parts and a secure mount. Correct as required before use.
2. Position the drawbar eye over the horn of the pintle and lower into place (**Figure 10 and 11**).
3. Engage the drawbar with the coupling device per the manufacturers instructions.



WARNING Failure to correctly secure the drawbar can result in separation of the pintle hook and drawbar, which, if not avoided, could result in death or serious injury.

Figure 9

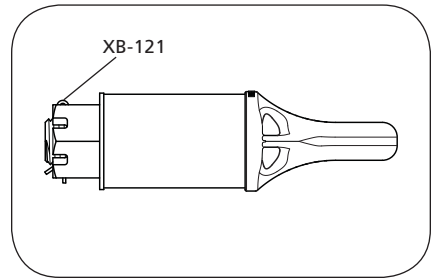

Figure 10

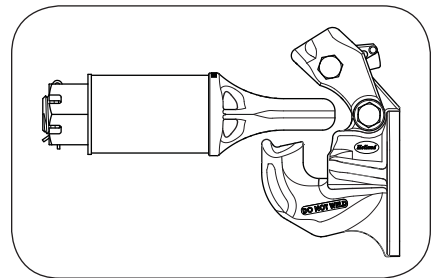
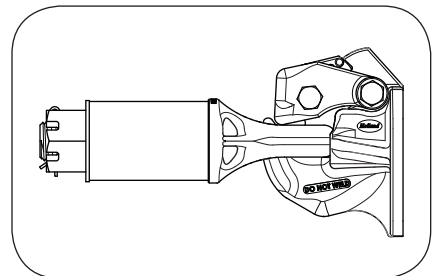

Figure 11



9. Maintenance

For proper performance, the following maintenance steps should be performed every 30,000 miles (48,280 km) or three (3) months, whichever comes first.

⚠ WARNING Failure to inspect and maintain the drawbar may result in separation of the pintle hook and drawbar, which, if not avoided, could result in death or serious injury.

1. Clean and check for wear, damaged, or missing parts, and a secure mount. Inspect for worn, damaged or missing parts. Replace as required using only Genuine SAF-HOLLAND® parts.
2. Inspect, in particular, the coupling contact area of the drawbar. Inspect for any nicks, gouges and deformation, which may interfere with or affect the safe use of the drawbar. If cracks are visible, replace.
3. Using calipers or the SAF-HOLLAND® drawbar gauges TF-11887, measure the cross section of the drawbar eye. Replace the complete product when wear exceeds 0.125" (3.18 mm) from the original surface profile. For original profile dimension (Refer to Section 2, page 5 Dimensions).
4. Inspect the drawbar fasteners. For bolted connections refer to proper torque in Section 7. In addition to being a safety hazard, a loose drawbar will cause excessive "chucking" and rapid wear. Reinstall or replace any drawbar which is NOT securely mounted.





From fifth wheel rebuild kits to suspension bushing repair kits, SAF-HOLLAND Original Parts are the same quality components used in the original component assembly.

SAF-HOLLAND Original Parts are tested and designed to provide maximum performance and durability. Will-fits, look-alikes or, worse yet, counterfeit parts will only limit the performance potential and could possibly void SAF-HOLLAND's warranty. Always be sure to spec SAF-HOLLAND Original Parts when servicing your SAF-HOLLAND product.

SAF-HOLLAND USA • 888.396.6501 • Fax 800.356.3929

www.safholland.us

SAF-HOLLAND CANADA • 519.537.3494 • Fax 800.565.7753

WESTERN CANADA • 604.574.7491 • Fax 604.574.0244

www.safholland.ca

SAF-HOLLAND MEXICO • 52.1.55.5456.8641 • Fax 52.55.58162230

www.safholland.com.mx

info@safholland.com

SAF-HOLLAND USA, INC.
1950 Industrial Blvd., Muskegon, MI 49443
www.safholland.com

