

Owner's Manual

PH-T-60-AOS-L-8

Swivel Mount Pintle Hook

Installation, Operation and Maintenance Procedures

- For On and Off-Road Applications
- Maximum GTW: 18,000 lb. (8,165 kg)
Maximum Vertical Load: 3,600 lb. (1,633 kg)
Weight (Approx.): 15 lb. (7 kg)

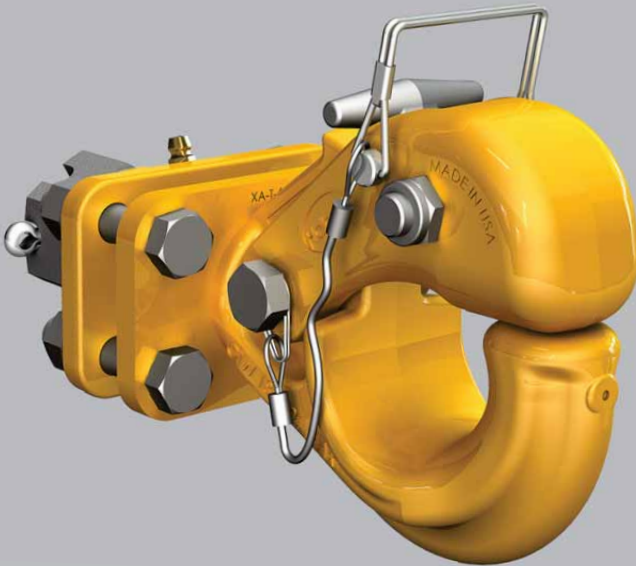

Contents	Page
Introduction.....	2
Warranty.....	2
Notes, Cautions, and Warnings	2
Section 1 – General Safety Instructions	3
Components Exploded View	4
Components Parts List.....	5
Dimensions	5
Section 2 – Drawbar Eye Dimensions.....	6

Contents	Page
Section 3 – Load Ratings per SAE J847	6
Section 4 – Towing Applications	6
Section 5 – General Information.....	6
Section 6 – General Safety Information	6
Section 7 – Mounting Instructions.....	7
Section 8 – Operating Instructions	11
Section 9 – Maintenance.....	12
Section 10 – Replacement Kits	13

Introduction

This manual provides information necessary for the proper operation, maintenance, and inspection of the SAF-HOLLAND® pintle hook.

NOTE: For HOLLAND® replacement components contact SAF-HOLLAND® Customer Service: 1-888-396-6501.

Warranty

Refer to the complete warranty for the country in which the product will be used. A copy of the written warranty can be downloaded from our SAF-HOLLAND® website (www.safholland.us).

Notes, Cautions, and Warnings

Read this manual and understand all of the procedures presented in it, before starting any work on the pintle hook.

NOTE: In the United States, work shop safety requirements are defined by federal and/or state Occupational Safety and Health Act. Equivalent laws could exist in other countries. This manual is written based on the assumption that OSHA or other applicable employee safety regulations are followed by the location where work is performed.

Proper tools **MUST** be used to perform the maintenance and repair procedures described in this manual.

This manual contains the terms “NOTE”, “IMPORTANT”, “CAUTION”, and “WARNING” followed by important product information. These terms are defined as follows:

NOTE: Includes additional information to enable accurate and easy performance of procedures.

IMPORTANT: Includes additional information that if not followed could lead to hindered product performance.

CAUTION Used without the safety alert symbol, indicates a potentially hazardous situation which, if not avoided, could result in property damage.

CAUTION Indicates a potentially hazardous situation which, if not avoided, could result in minor or moderate injury.

WARNING Indicates a potentially hazardous situation which, if not avoided, could result in death or serious injury.

1. General Safety Instructions

IMPORTANT: Read this manual before using this product. Keep this manual in a safe location for future reference.

WARNING Failure to follow the instructions and safety precautions in this manual can result in equipment failure which, if not avoided, could result in death or serious injury.

Read and observe all Warning and Caution hazard alert messages in this publication. The alerts provide information that can help prevent serious personal injury, damage to components, or both.

NOTE: In this manual, all descriptions of orientation are relative to the vehicle.

FRONT

PH-775SL11 ILLUSTRATED

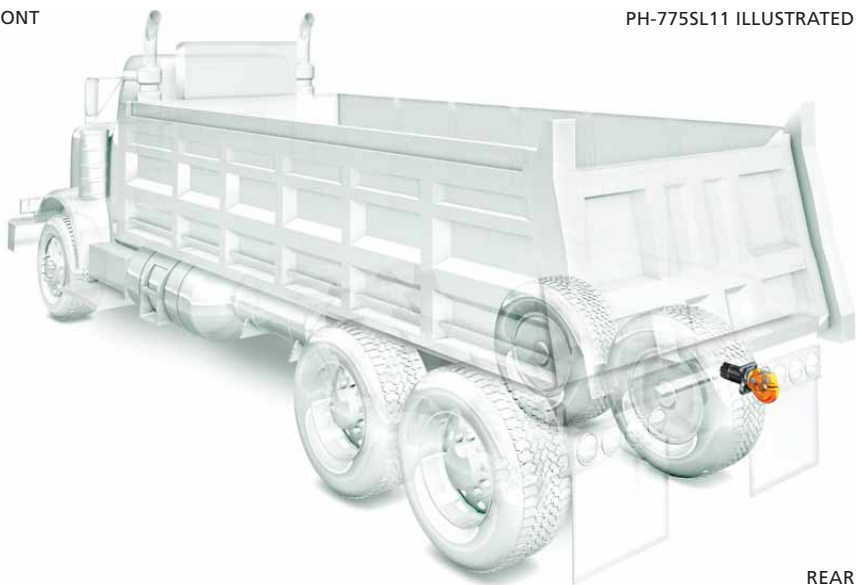

REAR

Exploded View



SAF-HOLLAND Group

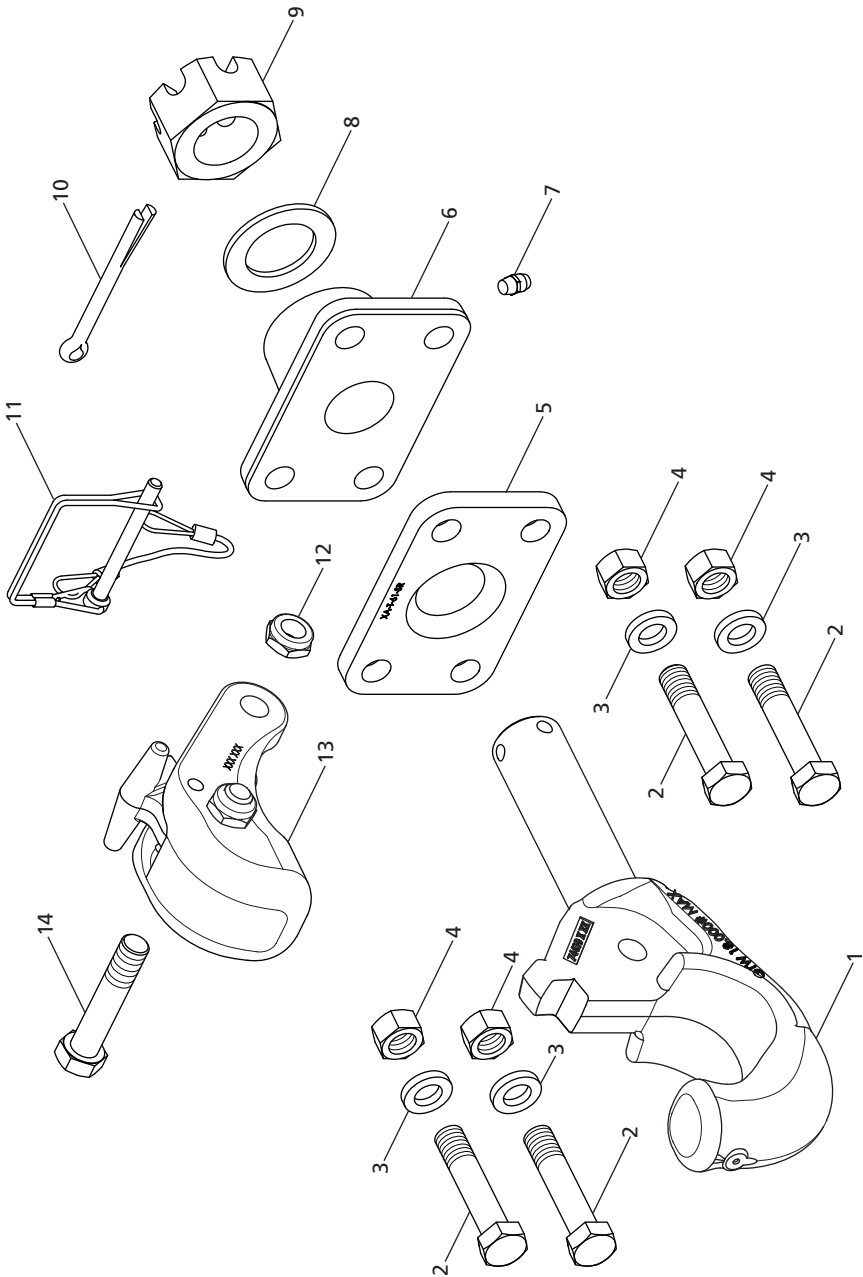

PH-T-60-AOS-L-8 PARTS LIST			
ITEM	DESCRIPTION	PART NUMBER	QTY.
1	Hook, Pintle (Pintle Hook)	XA-T-60-0S1	1
2	HHCS 1/2"-20 x 2-1/2" (1/2" Flange Bolts)	XB-T-89	4
3	Washer, Lock 1/2" (1/2" Flange Lock Washers)	XB-T-45-1	4
4	Nut, 1/2"-20 (1/2" Flange Nuts)	XB-758	4
5	Bracket, Rear Pintle (Rear Flange)	XA-T-61-SR	1
6	Bracket, Front Pintle (Front Flange)	XA-T-61-SF	1
7	Fitting, Lube 1/4"-20 Taper (1/4" Grease Fitting)	XB-767	1
8	Washer, Special (Pintle Washer)	XA-T-88	1
9	Nut, Hex Slotted 1-1/4"-12 (1-1/4" Castle Nut)	XB-T-20-2	1
10	Cotter, 1/4" x 3" (Cotter Pin)	XB-773	1
11	1/4" Wire Lock Pin and Lanyard (Tethered Lock Pin)	XB-11895	1
12	Nylon Insert Jam Nut, 1/2"-20 (1/2" Latch Nut)	XB-11048	1
13	Lock, S/A (Latch Assembly)	XA-T-62-O-1L-8	1
14	HHCS 1/2"-20 x 2-1/2" (1/2" Latch Bolt)	XB-T-89-4	1

Note: Not all component parts are for sale individually. For replacement kits, refer to Section 10. For individual component parts please call +1 (888) 396-6501.

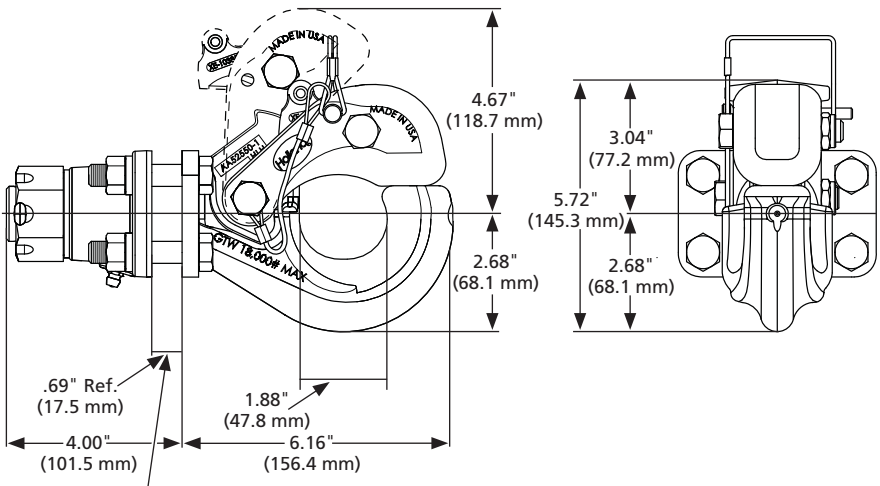

NOTE: Mounting flanges allow for a maximum 11/16" plate.

2. Drawbar Eye Dimensions

2" (50.8 mm) to 3" (76.2 mm) I.D with a 1.25" (31.8 mm) to 1.63" (41.3 mm) diameter cross section.

3. Load Ratings Per SAE J847

This product meets or exceeds the testing requirements for SAE J847 Type II Loads.

Maximum GTW: 18,000 lb. (8,165 kg)

Maximum Vert. Load: 3,600 lb. (1,633 kg)

4. Towing Applications

For general on/off road towing. Use ONLY with a non-swivel type drawbar. For severe off-road applications, reduce the above capacities by 25%.

IMPORTANT: Off-road refers to terrain on which a tow/towed vehicle will operate that is ungraded, rough or undulating, with no maintained travel surface, generally considered to NOT be part of the public road system. Examples include agricultural fields, construction sites, utility right-of-way, temporary logging roads, and what is commonly referred to as 'two-track' roads.

5. General Information

1. DO NOT modify or add to the product.
2. DO NOT weld on this product.
3. This product is covered by SAF-HOLLAND® Commercial Warranty. SAF-HOLLAND® reserves the right, without giving prior notice, to change specifications and dimensions as designs are altered or improved.

4. Inspect the coupling device on the tow vehicle for proper operation. DO NOT use any coupling device that DOES NOT operate properly.
5. Other steps and inspections are also required. Consult D.O.T. Regulations and American Trucking Association for complete coupling and uncoupling procedures. These cover items such as cargo securement, brakes, lights, safety chains, and other important requirements.

6. General Safety Information

This equipment MUST NOT be used in a careless manner.

During Operation:

1. Maintain adequate vertical (tongue) load to properly control the towed unit (generally 10% of maximum GTW) but DO NOT exceed the rated capacities.
2. DO NOT damage the latch. Be particularly careful during coupling and uncoupling.
3. Wear safety goggles during installation and removal.
4. NEVER strike any part of the item with a steel hammer.

7. Mounting Instructions

NOTE: It is suggested that this installation be performed with two persons.

1. Before installation make sure that the mounting structure is of sufficient strength to support the rated capacities of the pintle hook. Refer to SAE J847 for structural performance requirements.
2. The bolt holes and mounting clearance area are detailed in **(Figure 3)**.
3. During disassembly retain all components on a clean work surface to avoid any loss or damage.
4. Begin disassembly by removing the four (4) 1/2" Grade 5 flange bolts (XB-T-89), the four (4) 1/2" flange nuts (XB-758), and four (4) lock washers (XB-T-45-1) **(Figure 1)**.
5. Remove the cotter pin (XB-773) **(Figure 2)**.

Figure 1

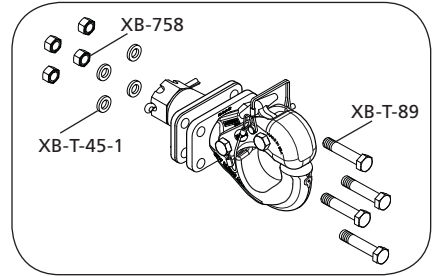

Figure 2

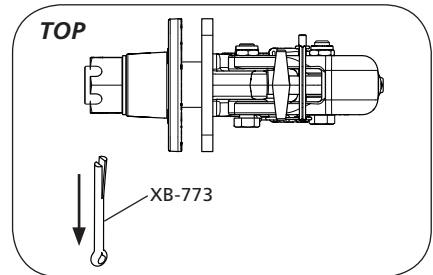
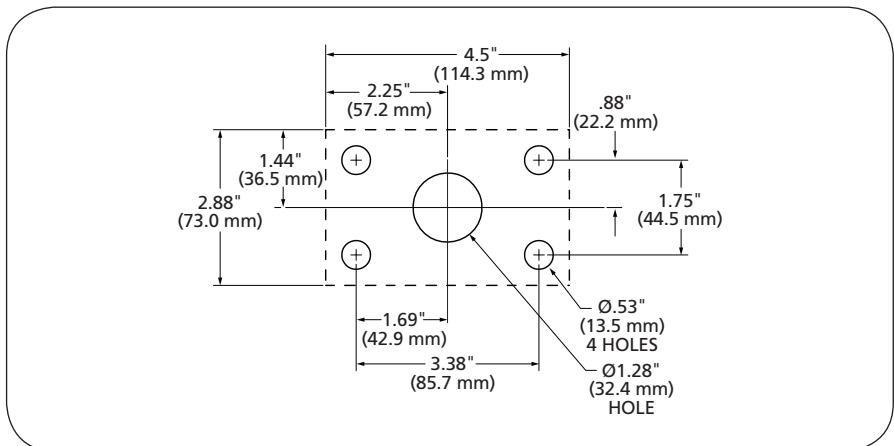

Figure 3



6. Remove the castellated nut (XB-T-20-2) (**Figure 4**).
7. Remove the pintle washer (XA-T-88) (**Figure 5**).
8. Remove the front flange (XA-T-61-SF) (**Figure 6**).
9. Remove the rear flange (XA-T-61-SR) (**Figure 7**).

Figure 4

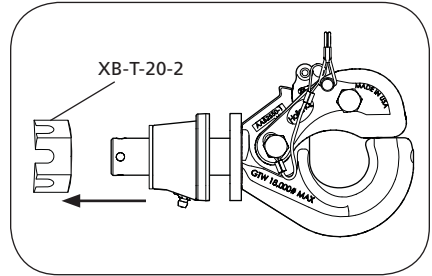

Figure 5

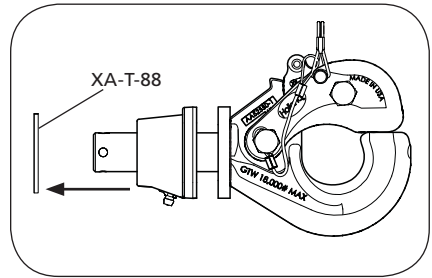

Figure 6

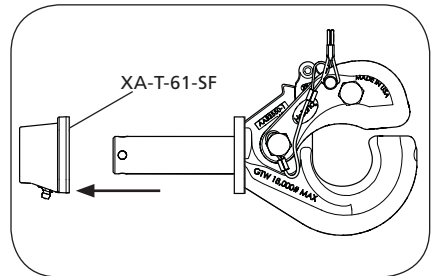
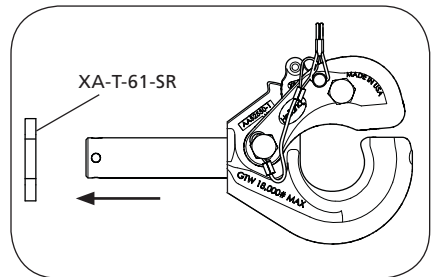
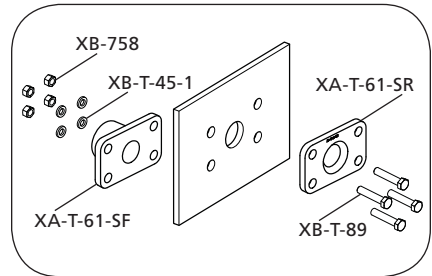
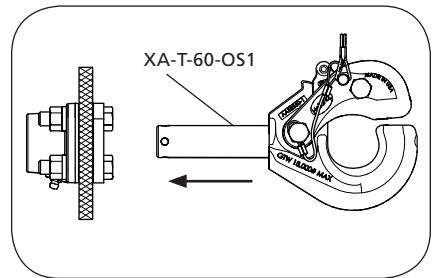
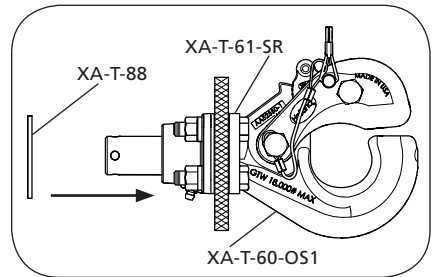
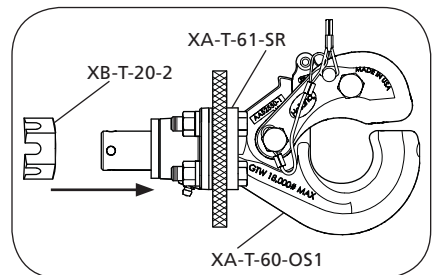

Figure 7



10. Using the four (4) 1/2" flange bolts (XB-T-89), the four (4) 1/2" lock washers (XB-T-45-1), and the four (4) 1/2" flange nuts (XB-758), loosely assemble the front flange (XA-T-61-SF) and rear flange (XA-T-61-SR) to the mounting structure. Hand tighten only at this time to hold the assembly in place (**Figure 8**).
11. Install the pintle hook (XA-T-60-OS1) allowing the pintle shank to align the loosely assembled flanges (**Figure 9**).
12. While holding the pintle hook (XA-T-60-OS1) compressed against the rear flange (XA-T-61-SR) install the washer (XA-T-88) (**Figure 10**).
13. While holding the pintle hook (XA-T-60-OS1) compressed against the rear flange (XA-T-61-SR) install castellated nut (XB-T-20-2). Hand tighten only at this time to hold the assembly in place (**Figure 11**).
14. Properly tighten the four (4) flange bolts (XB-T-89) and four (4) flange nuts (XB-758). The recommended minimum torque is 60 ft-lbs. (81.4 N•m).
15. Torque the castellated nut (XB-T-20-2) to 25 ft-lbs. (33.9 N•m).

Figure 8

Figure 9

Figure 10

Figure 11

16. Back off the castellated nut (XB-T-20-2) until the hole in the shank first becomes visible through a castellation of the nut (**Figure 12**).
17. Insert the cotter pin (XB-773) (**Figure 13**).
18. When the cotter pin is completely inserted spread the ends of the cotter pin (XB-773) (**Figure 14**).
19. The pintle hook should rotate freely by hand.
20. Grease the housing using the grease fitting (XB-767) (**Figure 15**). Wipe away excess grease to avoid attracting debris.

Figure 12

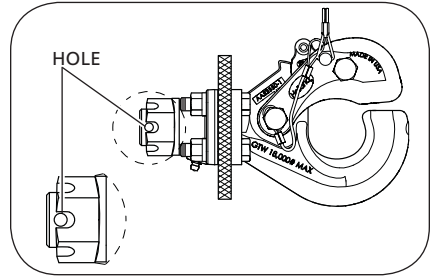

Figure 13

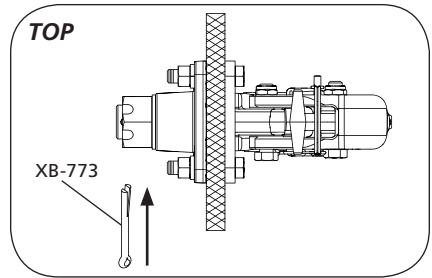

Figure 14

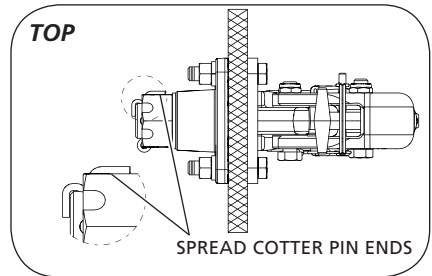
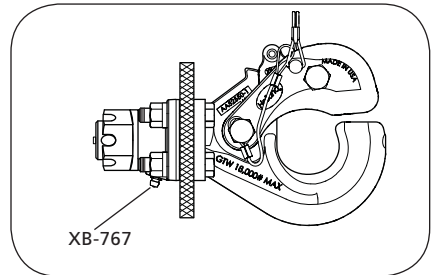

Figure 15



8. Operating Instructions

1. Before operating, inspect for proper operation, worn, damaged, or missing parts, and a secure mounting. Correct as required before use.
2. Make sure the pintle is in the proper coupling position with the latch on top (**Figure 16**).
3. Unlock and remove the tethered lock pin (**Figure 17**).
4. Lift the lock handle away from the vehicle until the lock clears the lock seat on the hook body, open the latch by rotating the latch assembly up towards the vehicle until the latch is in its most upright position, then release the lock handle (**Figure 17 and Figure 18**).
5. Position the drawbar eye over the horn of the pintle and lower into place.
6. Push the latch closed. When correctly locked, the lock will rotate and fully seat into the lock seat (**Figure 19a and Figure 19b**).
7. Insert the tethered lock pin through the latch and lock holes, and then close the tethered lock pin (**Figure 16**).

WARNING Failure to correctly lock the latch can result in separation of the pintle hook and drawbar, which, if not avoided, could result in death or serious injury.

Figure 19a

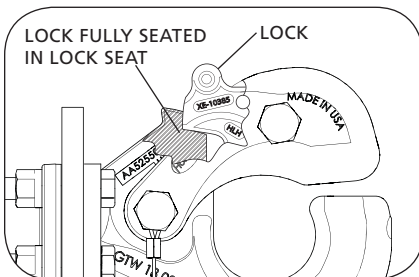

Figure 16

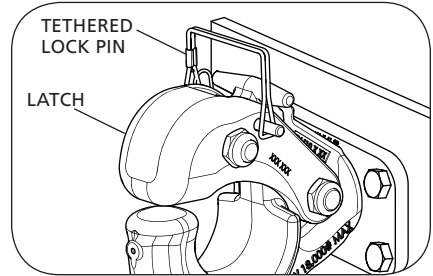

Figure 17

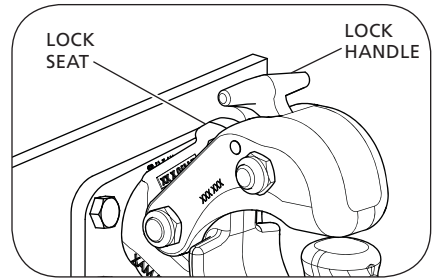

Figure 18

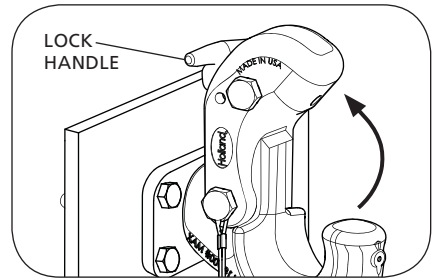
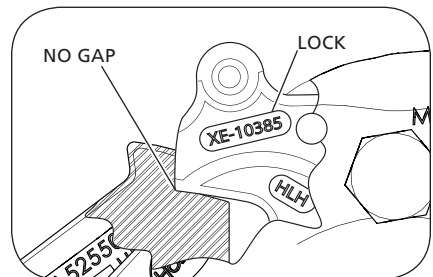

Figure 19b



9. Maintenance

For proper performance, the following maintenance steps should be performed every 30,000 miles (48,280 km) or three months, whichever comes first.

WARNING Failure to inspect and maintain the pintle hook could result in separation of the pintle hook and drawbar, which, if not avoided, could result in death or serious injury.

1. Clean and check for proper operation. Inspect for worn, damaged or missing parts. Replace as required using only Genuine SAF-HOLLAND® parts.
2. Carefully inspect the drawbar contact area. Replace the complete pintle hook when wear exceeds 0.188" (4.76 mm) from the original surface profile. Wear gage (TF-10522) is available for purchase (**Figure 20**).
3. With the latch closed, measure the gap between the hook and the latch while lifting up on the latch. Replace the latch when the gap exceeds 0.25" (6.35 mm) (**Figure 21**). Refer to Section 10.
4. Check for axial play by pushing and pulling, fore and aft on the pintle hook. Excessive axial play should be reduced by removing the cotter pin, re-torquing the castle nut, and reinstalling the cotter pin. Refer to Section 7, Step 16 and 17. Verify the pintle hook will rotate freely by hand.

Figure 20

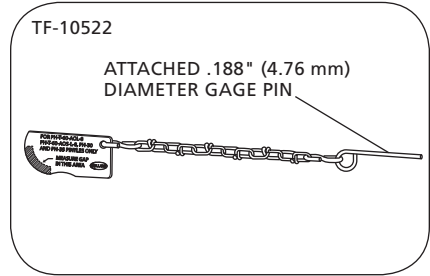
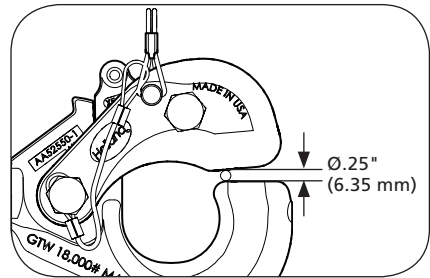

Figure 21



10. Replacement Kits

Flange Kit (RK-T-61)

If the flanges become worn or damaged, order flange kit (**Figure 22**).

FLANGE KIT RK-T-61			
ITEM	DESCRIPTION	PART NUMBER	QTY.
1	Cotter, 1/4" x 3" (Cotter Pin)	XB-773	1
2	Nut, 1/2"-20 (1/2" Flange Nuts)	XB-758	4
3	Washer, Lock 1/2" (1/2" Flange Lock Washers)	XB-T-45-1	4
4	Fitting, Lube 1/4"- 20 Taper (1/4" Grease Fitting)	XB-767	1
5	Bracket, Front Pintle (Front Flange)	XA-T-61-SF	1
6	Bracket, Rear Pintle (Rear Flange)	XA-T-61-SR	1
7	HHCS 1/2"-20 x 2-1/2" (1/2" Flange Bolts)	XB-T-89	4

Figure 22

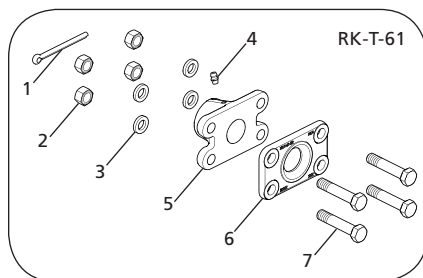
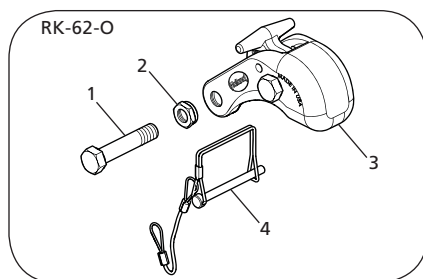

Figure 23



Latch Kit (RK-62-0)

If the latch becomes worn or damaged, order latch kit (**Figure 23**).

LATCH KIT RK-62-0			
ITEM	DESCRIPTION	PART NUMBER	QTY.
1	HHCS 1/2"-20 x 2-1/2" (1/2" Latch Bolt)	XB-T-89-4	1
2	Nylon Insert Jam Nut, 1/2"-20 (1/2" Latch Nut)	XB-11048	1
3	Lock, S/A (Latch Assembly)	XA-T-62-O-1L-8	1
4	1/4" Wire Lock Pin and Lanyard (Tethered Lock Pin)	XB-11895	1







From fifth wheel rebuild kits to suspension bushing repair kits, SAF-HOLLAND Original Parts are the same quality components used in the original component assembly.

SAF-HOLLAND Original Parts are tested and designed to provide maximum performance and durability. Will-fits, look-alikes or, worse yet, counterfeit parts will only limit the performance potential and could possibly void SAF-HOLLAND's warranty. Always be sure to spec SAF-HOLLAND Original Parts when servicing your SAF-HOLLAND product.

SAF-HOLLAND USA • 888.396.6501 • Fax 800.356.3929
www.safholland.us

SAF-HOLLAND CANADA • 519.537.3494 • Fax 800.565.7753
WESTERN CANADA • 604.574.7491 • Fax 604.574.0244
www.safholland.ca

SAF-HOLLAND MEXICO • 52.1.55.5456.8641 • Fax 52.55.58162230
www.safholland.com.mx

info@safholland.com

SAF-HOLLAND USA, INC.
1950 Industrial Blvd, Muskegon, MI 49443
www.safholland.com

