



TRUCK TRAILER AND BUS SHOCKS



USA
800.876.3929
safholland.us

Canada
519.537.3494
safholland.ca

Western Canada 604.574.7491



FRONT_{TO}BACK

SAF-HOLLAND ORIGINAL PARTS



NEWAY

SUSPENSIONS



Holland

FIFTH WHEELS

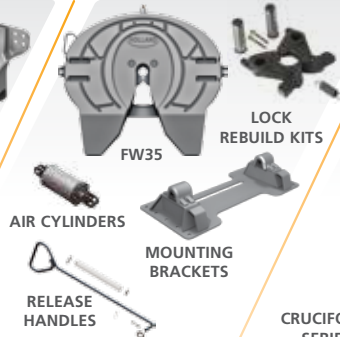

Holland

KINGPINS



SAF

SUSPENSIONS



Holland

LANDING GEAR

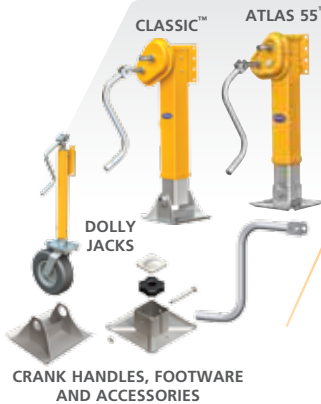

Holland

COUPLINGS



Holland

BUMPER TUBES

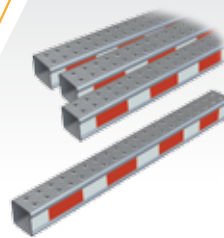

safholland.com
800.876.3929

Canada
519.537.3494

Mexico
52.55.5816.2230

SAF-Holland
ORIGINAL PARTS™

SAF **Holland** **NEWAY**

ORIGINAL SERVICE PARTS TO KEEP YOU ROLLING

Table of Contents

New Part Numbers / Part Numbers Superseded	2
Application and Numerical Listings	
Specialty Shocks	3
Medium Duty & Heavy Duty Trucks, Trailers & Buses Application Listing	5
Medium Duty & Heavy Duty Trucks, Trailers & Buses Numerical Listing.....	205
Competitive and OEM Interchange	217
How to Determine the Correct Shock for Your Truck	262
Specifications by End Mount	270
Specifications by Part Number	284
Mounting Accessory Packages and Component Parts	298
Mounting Accessory Packages - Buyer's Guide	301
Fleetline / GasSLX Interchange	303

**NEW PART NUMBERS IN THIS CATALOG
NOUVEAUX NUMÉROS DE PIÈCES DANS CE CATALOGUE
NUMERACION NUEVA DE PARTES EN ESTE CATALOGO**

83065	83177	83518	85122	85180	85994
83066	83178	83519	85123	85181	85995
83067	83180	85109	85124	85351	85998
83175	83389	85119	85125	85745	85999
83176	83515	85120	85126	85746	

**PART NUMBERS SUPERSEDED
NUMÉROS DE PIÈCES REMPLACÉS
NUMERACION DE PARTES REEMPLAZADOS**

DELETE	THEN USE	DELETE	THEN USE
83032	83025	85330	85379
83200	89402	85714	85715
85050	83221	85717	85715
85312	85733	85718	85732
85324	85342	89403	89401

**PARTS TO BE DISCONTINUED WHEN INVENTORY IS DEPLETED
CES PIÈCES NE SERONT PLUS FABRIQUÉES UNE FOIS LES STOCK ÉPUISÉS
LAS PARTES SE DESCONTINUARÁN AL AGOTAR EXISTENCIAS**

83014	83172	85073	85701	85730	85913	85944	85949
83043	83173	85074	85703	85731	85940	85945	85950
83046	83353	85075	85707	85905	85941	85946	85951
83115	83634	85076	85710	85907	85942	85947	89412
83165	83636	85077	85719	85912	85943	85948	89416

**12 YEAR SUPERSEDURE LIST
LISTE DE REMPLACEMENT DES 12
LISTA DE REEMPLAZOS DE 12 AÑOS**

LAST YEAR IN CATALOG	DELETE	THEN USE	LAST YEAR IN CATALOG	DELETE	THEN USE
2006	83106	83136	2006	85326	85336
2006	83121	83137	2007	85328	83136
2007	83132	83140	2006	85922	85920
2005	85044	85058	2006	87001	85734
2007	85048	83136	2006	87002	85736
2006	85049	85071	2006	87004	85735
2007	85057	85907	2006	87006	85736
2007	85325	83136	2010	632155	646155 / 646177

APPLICATION GUIDE - SPECIALITY

Year Año Année	Model Modelo Modèle	OEM #	Fleetline #
ADVANCE MIXER			
	Rear Discharge Mixers with Self - Steering Axle Shock	12111 ADV	646155
CHALLENGE			
	Cement Mixer	632147 632155	632147 646177
GRANNING SUSPENSION			
	Model L120 Self Steer Axle	701071-01	646155
HENDRICKSON TRAILER SUSPENSION SYSTEMS			
Auxiliary Lifiable Steerable System (HL)			
	HLP Paralift	A-14496	646155
	HLU Paralift Ultra	A-14496	646155
INGERSALL MACHINE			
	700060-0 Axle Assy.	665472	665472
	Models with O.E.M. Number	665904	665472
KIMBLE MIXER CO			
	Rear Discharge Mixers with Self - Steering Axle Shock	OE10455	646155
LINK/HIGH-STEER			
	6000 Steering Stabilizer	632155	646177
	9000 Steering Stabilizer	1210-0007 1210-0009	665937 665937
	Models with O.E.M. Number	1210-0001 1210-0002 1210-0010 1210-0012 646168	646155 632147 646155 646155 646155
LONDON MIXER			
	Rear Discharge Mixers with Self - Steering Axle Shock	MB-37737-30	646155
MC NEILUS TRUCK & MAN.			
	Booster Axles	1170719 600-115994B	632147 632147
	Bridgemaster V models with Self - Steering Axle Shocks	600-188206	646155
	Models with O.E.M. Number	1473224 2034140 MTM 600-11599M	646155 646155 632147
	Pusher Axles	600-115994B	632147
OSHKOSH MOTORS			
	Models with O.E.M. Number	2034140	646177
PIERCE MANUFACTURING INC.			
	Models with O.E.M. Number	2034140	646177
REX MIXER			
	Rear Discharge Mixers with Self - Steering Axle Shock	102-13441-10	646155
REYCO SUSPENSION			
	L132 Steering Stabilizer	701071-01	665937
RIDEWELL CORPORATION			
	RLT-230	1310002	665937
	RSS-232	1317570B001	646155
	RSS-236/R	1310002 1310004	665937 665937
SAF HOLLAND			
	Self - Steering Axle Shocks	646201 90045331	646177 646155

APPLICATION GUIDE - SPECIALITY

Year Año Année	Model Modelo Modèle	OEM #	Fleetline #
----------------------	---------------------------	-------	-------------

SAF HOLLAND (Cont'd.)

Neway V-Steer II (Cont'd.)

	Self - Steering Axle Shocks	632155	646177
--	-----------------------------	--------	--------

SPRING VALLEY

	SS120 Steering Stabilizer	632155	646177
	SS130L Steering Stabilizer	632155	646177

SUSPENSIONS INC.

	LP11 Steerable Lift Axle	200188	646155
--	--------------------------	--------	--------

TEREX CORPORATION

	Rear Discharge Mixers with Self - Steering Axle Shock	12111	646155
--	---	-------	--------

TUTHILL TECHNOLOGIES

	Models with O.E.M. Number	66502	646155
--	---------------------------	-------	--------

VARIOUS

Steering Stabilizer

	Various Class 8 Trucks with Front Axle Rating of 10,000 lb to 20,000 lb	SC-2920	83176
--	---	---------	-------

WATSON & CHALIN MFG. INC.

Self - Steering Axle Suspension Systems

	LW5L-1100 SR	11418	646155
	Models with O.E.M. Number	17069	632147
	SL-2089 Steerable Lift Axle Suspension	11418	646155
	WCAL-1000 SST	11418	646155
	WCAL-1100 LR	11418	646155
	WCAL-1100 SR	11418	646155
	WCAL-1100 SRLP	11418	646155
	WCAL-1100 SSR	11418	646155
	WCHL-1100 FL	11418	646155
	WCHL-1100 HI-LIFT	11418	646155

WESTPORT AXLE CORP

	Self - Steering Axle Shocks	143699-0185 646124	646177 646177
--	-----------------------------	-----------------------	------------------

APPLICATION GUIDE - TRUCKS, TRAILERS, AND BUSES

Year Año Année	Model Modelo Modèle	OEM #	Front		Rear	
			Fleetline	GasSLX	Fleetline	GasSLX

ABC BUS

	Drive Axle	12J-5-10		0 -	85733	...
	T2100 Van Hool Buses with O.E.M. Number (Front & Tag Axle)	10685703	- -	695406
		624314570	- -	695406
		90-2291	- -	695406
	Models with O.E.M. Number	050134513	0 0	85732
		12L-5-88		0 -	85729	...
		6243-13790	- -	85708
		6243-14040	- -	85708
	Additional O.E.M. Interchanges	12B-5-1	0 0	85735				
		12L-5-114	- -	85727				
		12L-5-72	- -	85709				
		3166657	0 0	85700				
		680323	0 0	85700				

ACF BRILL BUS

	37R Models	0 0	83225
	C-27 and C-31 City Bus		85307	...	0 0	85307	...
	C-36 City Bus Serial #1051 and on		85307	...	0 0	85307	...
	C-37M Models		83225	...	0 0	83225	...
	C-44 City Bus and T-44 Trolley Bus		85308	...	0 0	85308	89422
	IC-41 Intercity Bus Serial #1088 and on		85308	...	0 0	85308	89422
	IC-41 Intercity Bus to Serial #1088		85307	...	0 0	85307	...
	Additional O.E.M. Interchanges	610513	0 0	85307				
		631237	0 0	85308 or 89422				
		641521	0 0	85308 or 89422				
		649648	0 0	85308 or 89422				
		659129	0 0	85303 or 89422				
		661732	0 0	83215				
		661733	0 0	83225				
		995891	0 0	85307				

ADVANCE MIXER

	Advance Mixer part number	13424 ADV	0 0	0 0	83207	89407
		13883 ADV		85334
		14626 ADV		0 0	83209	...
		23458 ADV		0 -	83112	...
	Models with O.E.M. Number	13883	0 0	85334
		680087	0 0	85334





ALLCO TRAILER

	Dump Trailers with Watson & Chalin TA-5000-DB-19 Air Suspension	727602		0 0	83122	89406
--	---	--------	--	-----	-----	-----	-------	-------

AM GENERAL

	Small Bus	5979484		0 0	85302	89420
	Additional O.E.M. Interchanges	3166657	0 0	85700				
		4975501	0 0	85700				
		5565748	0 0	85700				
		5957136	0 0	85700				
		5969438	0 0	85700				
		5978712	0 0	85700				
		5979574	0 0	85700				

APPLICATION GUIDE - TRUCKS, TRAILERS, AND BUSES

Year Año Année	Model Modelo Modèle	OEM #	Front		Rear	
						
			Fleetline	GasSLX	Fleetline	GasSLX

AM GENERAL(Cont'd.)

Additional O.E.M. Interchanges	5982537	010	85700
--------------------------------	---------	-----	--------------

ARVIN MERITOR

Blue Bird Motor Home with IFS (37 Foot)	7805-N-1002	010	85329	
	7805-S-1007	010	85329	
Models with Manufacturing Number	085009	-10	85009				
	085014		010	85014	...
	085321		010	85321	...
	654907		010	85000	89436
	659222	010	83171
	665724		010	85000	89436
	665760		010	85045	...
	665769		010	85052	...
	665804		010	85939	...
	671091		-1-	85069	89455
	671092	010	85012	89413	
	671507		010	87015	...
	671707		010	85052	...
	680102	010	85712				
	680322	010	85704				
	680518	010	85700				
	680584		010	85938	...
	680671		-1-	85708	...
	695172	-1-	85707				
	695214	-1-	85722				
695406	-1-	695406					





AUTOCAR

A42B, A42F, A64B A64F Models From Feb. 1971 Thru Jan. 1971	03-1106460	010	85005	89430	
	28R010	010	83216	
ACM, ACL Models	35901-3201		010	85024	89416
	37301-3201	-1-	85027	89418	
C65T, C70T, C70TS, C90, C75, C90T, DC74, DC75, DC102, DC104 Models	010	83216
DC87T, DC9364 From Feb. 1971	010	83122	89406	
Models with Air Suspension and O.E.M. Number	8026658		010	85046	89434
	8071524		010	85024	89416
Models with O.E.M. Number	1011839	010	83216
	28CFG-910	010	83216
	37301-3202	01-	85026	89417	
	660186	010	83216
	849246	010	83216

XPEDITOR

08 - 16	4 X 2 Models with Hendrickson Primaax EX 232 Air Suspensions Standard with 8 1/2" to 10" Ride Height	60657-003	010	85072	...
08 - 16	6 X 4 Models with Hendrickson HMX 400/460 Haulmax with 16.5" Saddle	60680-004	01-	83143	...
08 - 16	6 X 4 Models with Hendrickson HMX 400/460 Haulmax with 17.5" & 18.5" Saddle	60680-005	01-	83142	...
08 - 16	6 X 4 Models with Hendrickson HN - 522	60680-003	01-	83112	...

APPLICATION GUIDE - TRUCKS, TRAILERS, AND BUSES

Year Año Année	Model Modelo Modèle	OEM #	Front		Rear	
						
			Fleetline	GasSLX	Fleetline	GasSLX

AUTOCAR(Cont'd.)

XPEDITOR(Cont'd.)

08 - 16	6 X 4 Models with Hendrickson Primaax EX 462 Air Suspensions Standard with 12 1/2" - 14 3/8" - 15 1/2" Ride Height	60665-011						
	Standard with 8 1/2" to 10" Ride Height	60657-003	OIO	85967
08 - 16	8 X 4 Models with Chalmers 800 Series - 46K Tandem Truck Suspensions (HD Shock Kit with High Mounts)	800670					85060	...
08 - 16	8 X 4 Models with Chalmers 800 Series - 46K Tandem Truck Suspensions (HD Shock Kit with Low Mounts)	800781					85314	89425
08 - 16	8 X 4 Models with Hendrickson Primaax EX 462 Air Suspensions Standard with 12 1/2" - 14 3/8" - 15 1/2" Ride Height	60665-011					85967	...
	Standard with 8 1/2" to 10" Ride Height	60657-003	OIO	85072

BECK BUS

	Deck and 1/2 Bus - Spring Suspension						
	Deck and 1/2 Bus - Trailing Wheel					85307	...
	Deck and 1/2 Bus with Air Suspension
	Luxury Liner Bus - Spring Suspension					85304	...
	Mainliner with Air Suspension
	Models with O.E.M. Number	14QK-140	OIO				85304	...
		14QK-2102				

BENSON TRUCK BODIES INC.

	Models with Hendrickson Intrax Air Suspension	A-20002						
	Models with Neway Air Suspension	90044089				

BERING TRUCK CORP.





	HD80TT Models with Hendrickson HAS-400 Air Suspension	47902-24						
	Models with Hendrickson HAS-230 Air Suspension	47902-24				

BLUEBIRD SCHOOL BUS

All American Series (FE & RE Models)

	Buses with 13,200 lb, 2-Leaf Parabolic Springs	1658525						
		AMS65109	OIO				85971	...
	Buses with 19,000 lb - 21,000 lb - 2 Stage Leaf Springs	AMS65110					85058	89431
06 - 13	Buses with Comfort Air Suspensions	00085991				
		471700000428					OIO	85005
		60998-001					OIO	85006
		60998-003					OIO	85006
	Buses with Hendrickson Airtex Front Air Suspension	0110808	OIO				83124	89407
- 15	Buses with Hendrickson Airtex Front Air Suspension (13, 200 to 14,600 lb Capacity)	58913-011	OIO				85959	...
98 - 15	Buses with Hendrickson Parasteer Suspensions	0015222	OIO				85919	...
		0040015	OIO				85919	...
		481700131438	OIO				85919	...
		59483-000	OIO				85919	...
		60665-005	OIO				85919	...
		60998-002	OIO				85919	...
- 15	Buses with Hendrickson Softek Suspension (13,200 lb - 14,600 lb Capacity)	0106303	OIO				85106	...
		471700002919	OIO				85106	...
		58913-010	OIO				85106	...
05 - 13	Buses with Leaf Spring Rear Suspension	0088035				

APPLICATION GUIDE - TRUCKS, TRAILERS, AND BUSES

Year Año Année	Model Modelo Modèle	OEM #	Front		Rear	
			 Fleetline	 GasSLX	 Fleetline	 GasSLX

BLUEBIRD SCHOOL BUS(Cont'd.)

All American Series (FE & RE Models)(Cont'd.)

	Buses with O.E.M. Number	0823054	010	85304
	RE (Rear Engine) Models with Ridewell RAS - 227 Steer Axle Air Suspension	1260008		010	87017	...
		90-2610 SP1		010	87017	...

D3 Series (FE & RE Models)

	Buses with Comfort Air Suspensions	00085991		010	85006	...
		471700000428		010	85006	...
		60998-001		010	85006	...
	Buses with Hendrickson Airtek Front Air Suspension	0110808	010	83124	89407	
12 - 15	Buses with Hendrickson Airtek Front Air Suspension (13, 200 to 14,600 lb Capacity)	58913-011	010	85959
- 15	Buses with Hendrickson Softek Suspension (13,200 lb - 14,600 lb Capacity)	0106303	010	85106
		471700002919	010	85106
		58913-010	010	85106
	Buses with Leaf Spring Rear Suspension	0088035		010	85090	...

TC 2000 Bus, TC/2000 FE Series

	Buses with Neway Rear Air Suspension	90045050		010	85914	...
	Buses with Ridewell Front Suspension Option #4540	1004167	010	85712
		1317767	010	85029
		1667831	010	85029
		300-1317767	010	85029
		AMS65119	010	85029
	Buses with Ridewell Rear Suspension Option #4540	1316546		010	85006	...
		1658533		010	85010	...
		305-0961284		010	85734	...
	Buses with Standard Flat Leaf Rear Springs	1746163		010	85006	...
	Buses with Standard Parabolic Front Springs	1658525	010	85971





Type A School Bus

92 - 17	MicroBird Type A School bus with Ford E350 Chassis	8C24-18045-DA	-10	83177
		8C2Z-18124-D	-10	83177
		ASH-1154	-10	83177
		AT-163G	-10	83177
		8C24-18080-DB		-10	83178	...
		8C2Z-18125-D		-10	83178	...
		ASH-1136		-10	83178	...
		AT-164G		-10	83178	...
00 - 17	MicroBird Type A School bus with Ford E450 Chassis	8C24-18045-DA	-10	83177
		8C2Z-18124-D	-10	83177
		ASH-1154	-10	83177
		AT-163G	-10	83177
		8C24-18080-DB		-10	83178	...
		8C2Z-18125-D		-10	83178	...
		ASH-1136		-10	83178	...
		AT-164G		-10	83178	...

Vision Series

06 - 15	Buses with Comfort Air Suspensions	00085991		010	85006	...
		471700000428		010	85006	...
		471700131545		010	85006	...
		60998-001		010	85006	...
		60998-003		010	85006	...
	Buses with Hendrickson Airtek Front Air Suspension	00119797	010	85959

APPLICATION GUIDE - TRUCKS, TRAILERS, AND BUSES

Year Año Année	Model Modelo Modèle	OEM #	Front		Rear	
						
			Fleetline	GasSLX	Fleetline	GasSLX

BLUEBIRD SCHOOL BUS(Cont'd.)









Vision Series(Cont'd.)

	Buses with Hendrickson Airtek Front Air Suspension	65992-003	010	85959
06 - 10	Buses with Hendrickson Airtek Front Air Suspension	58913-007	010	85959
06 - 15	Buses with Hendrickson Airtek Front Air Suspension (10,000 lb Capacity)	0055017	010	85959
		0085990	010	85959
		47170000456	010	85959
		58913-008	010	85959
		58913-009	010	85959
12 - 15	Buses with Hendrickson Airtek Front Air Suspension (13, 200 to 14,600 lb Capacity)	58913-011	010	85959
- 15	Buses with Hendrickson Softek Suspension (13,200 lb - 14,600 lb Capacity)	0106303	010	85106
		471700002919	010	85106
		58913-010	010	85106
06 - 15	Buses with Hendrickson Softek Suspension (8,500 lb - 10,000 lb Capacity)	0055008	010	85959
		0085990	010	85959
		47170000456	010	85959
		58913-007	010	85959
		58913-007L	010	85959
		58913-009	010	85959
05 - 13	Buses with Leaf Spring Rear Suspension	0088035		010	85090	...
		47170000464		010	85090	...

Additional Applications

	Buses with 3/4" Mounting Pins	2021459		85012	...	010	85012	89413
	Buses with 35" Chassis	303-1350628	010	85712
		90-1968	010	85712
	Buses with Flat Leaf Rear Spring Suspensions (8,200 lb to 10,400 lb)	1707405		010	85005	...
	Buses with Neway Air Suspensions with O.E.M. Number	1526417		010	85052	...
		90044448		010	85051	...
		90044915		010	83127	...
		90045083		010	85910	...
	Buses with Reyco Air Suspension	1668722	010	85030	89440	
		1668730		010	85013	89414
		1722222		010	85013	89414
	City Bird Buses with 1 " Mounting Pins	300-0614966	010	85307
		300-0614974		010	85304	...
		609180		010	85304	...
		614958	010	85307
		614966	010	85307
	FE Models School Bus (Front Engine)	0014605		010	85036	89405
		0014985		010	83137	...
		59057-001		010	83137	...
		59057-002		010	85036	89405
	Low Floor Bus Models with O.E.M. Number	0075916	010	85086
		4759272		- -	...	89447
		4760958	010	85086
		680667		- -	...	89447
	Motor Home with IFS (37 Foot)	7805-N-1002	010	85329
		7805-S-1007	010	85329
	RE Models School Bus (Rear Engine) with 1 " Mounting Pins	300-0614966	010	85307
		300-0614974		010	85304	...

APPLICATION GUIDE - TRUCKS, TRAILERS, AND BUSES

Year Año Année	Model Modelo Modèle	OEM #	Front		Rear	
						
						
			Fleetline	GasSLX	Fleetline	GasSLX

BLUEBIRD SCHOOL BUS(Cont'd.)

Additional Applications(Cont'd.)

	RE Models School Bus (Rear Engine) with 1 " Mounting Pins	609180	OIO	85304	...
		614958	OIO	85307
	WanderLodge Drive Axle Front with Reyco Air Suspension	1750793	OIO	85712	...
		90-1968-SP1	OIO	85712
		1722214	OIO	85030	89440
	WanderLodge LX, LXI - Models Front Rear	90-2497-SP1
		90-1951-SP1	OIO	85734	...
			OIO	85106
	Models with O.E.M. Number	00119798	OIO	85106
		0020326	OIO	85976	...
		300-1316546	OIO	85006	...
		614974	OIO	85304
		65992-004	OIO	85106
		680783	OIO	85304

Additional O.E.M. Interchanges

	Additional O.E.M. Interchanges	0523047	OIO	OIO	85736	...
		1217934	OIO	OIO	85304	...
		1962422	OIO	OIO	85304	...
		1962430	OIO	OIO	83207 or 89407	...
		23106-01	OIO	OIO	85975	...
		300-0823047	OIO	OIO	85736	...
		300-0823054	OIO	OIO	85304	...
		300-09612284	OIO	OIO	85734	...
		671933	OIO	OIO	85919	...
		680102	OIO	OIO	85712	...
		680155	OIO	OIO	85712	...
		70317	OIO	OIO	89402	...
		70397	OIO	OIO	85006	...
		7805-M-1001	OIO	OIO	85919	...
		87001-01A	OIO	OIO	85734	...
		90-1813	OIO	OIO	85712	...
A-4890	OIO	OIO	85712	...		

BOYDSTUN EQUIPMENT MANUFACTURING

	Trailers with Ridewell RAR-210 Suspensions	1253069B000	OIO	85005	89430
	Trailers with Ridewell RAR-221AS-11-USW, RAR-221AS-11-USW Suspensions	1253069B000	OIO	85005	89430





BREDA BUS

	Models with O.E.M. Number	500-403-4	OIO
--	---------------------------	-----------	-----	-----	-----	------	-----

BROCKWAY SCHOOL BUS

	257T, 260S, 260T Models	OIO	83207	89407
	300, 400, 500 Models With 1" Mounting Pins With 3/4" Mounting Pins	OIO	85307
		OIO	85012	89413
	55 and 61 Passenger School Bus With 1" Rear Mounting Pins With 3/4" Rear Mounting Pins	OIO	83216	...	OIO	85305
		OIO	83216
	88WH, 128W, 154W Models	OIO	83216

APPLICATION GUIDE - TRUCKS, TRAILERS, AND BUSES

Year Año Année	Model Modelo Modèle	OEM #	Front		Rear	
						
			Fleetline	GasSLX	Fleetline	GasSLX

BROCKWAY SCHOOL BUS(Cont'd.)

	Less than 55 Passenger School Bus	OIO	83216
	Models with O.E.M. Number	14QK-281P10	OIO	85305
		14QK-282P1	OIO	83216
		14QK-282P3	OIO	83216
		152398	OIO	85304
		152412	OIO	83215
		508657	OIO	85307
		515231	OIO	85303	89422	
		530873	OIO	83207	89407	
		532397	OIO	85307

BUILT RITE

	Models with Air Suspension	318-06-100		OIO	85006	...
--	----------------------------	------------	--	-----	-----	-----	--------------	-----

BUS & TRUCK CO.

	Silver Eagle	0100-905		85307	...	OIO	85307	...
		680091		85303	...	OIO	85303	89422
		70039		85303	...	OIO	85303	89422
		70041		85305	...	OIO	85305	...

CARPENTER BUS

	Models with O.E.M. Number	0272-SS5	OIO	85712
		63-0001		OIO	85713	...

CASCADE TRAILER

	Models with Air Suspension	120-1		OIO	83125	...
--	----------------------------	-------	--	-----	-----	-----	--------------	-----

CHALMERS SUSPENSION

	K800-199 Models Kit	665174		OIO	85060	...
	Single Axle Truck Suspension (1023-23K, 1030 -30K, 1040-40K)	665174		OIO	85060	...
	800 Series - 46K Tandem Truck Suspensins (HD Shock Kit with High Mounts)	800670		OIO	85060	...
	800 Series - 46K Tandem Truck Suspensins (HD Shock Kit with Low Mounts)	800781		OIO	85314	89425
	Models with O.E.M. Number	21335		OIO	G63355	...

CHAMPION TRANSIT

	GMC P6000 Chassis	22064230	- -	83136
		22064231		- -	85324	...

CHANCE BUS

	Models with O.E.M. Number	59039		83207	...	OIO	83207	89407
		665017		OIO	85014	...
		6892		83207	...	OIO	83207	89407
		6893		83203	89436	
		728600		83203	...	OIO	83203	89436
		AS789B		85014	...	OIO	85014	...
	Additional O.E.M. Interchanges	270-6708	OIO	85014				

CHANCE COACH

Additional Applications

	Buses with 3/4" Mounting Pins	2021459		85012	...	OIO	85012	89413
--	-------------------------------	---------	--	--------------	-----	-----	--------------	--------------

APPLICATION GUIDE - TRUCKS, TRAILERS, AND BUSES

Year Año Année	Model Modelo Modèle	OEM #	Front			Rear		
				Fleetline	GasSLX		Fleetline	GasSLX

CHEVROLET TRUCK (ALSO SEE GMC TRUCK)

4, 40, 4000 & 4500 Series

69 - 72	All - Exc. Tilt Cab	22012096 3192892		83221	...	OIO	83221	...
				83221	...	OIO	83221	...
63 - 68	C-40, P-40, SS-40 Models	OIO	85005	89430	OIO	83221	...
60 - 62	C-40 Models	OIO	83221	...
68	Cowl - Exc. School Bus	22012096 3192892	OIO	83221
			OIO	83221
69 - 70	D-D Forward Control with 9000 & 11000 lb Axles - Exc. Tilt Cab	22012096 3192892	OIO	83221
			OIO	83221
69 - 70	D-D Forward Control with Tilt Cab	22012095 4940606	OIO	83126	89430	
			OIO	83126	89430	
67 - 72	S-40 School Bus	22012096 3192892		83221	...	OIO	83221	...
				83221	...	OIO	83221	...
67 - 68	TDM 4 Cycle Detroit Diesel with Tandem Axle - Exc. Tilt Cab	22012096 3192892		OIO	83221	...
				OIO	83221	...





5, 50, 5000 & 5500 Series

69 - 72	All - Exc. Tilt Cab	22012096 3192892		83221	...	OIO	83221	...
				83221	...	OIO	83221	...
73 - 80	C, M, S Chassis - Conventional Cab	22007750 4975467 4975494	OIO	83207	89407	
			OIO	83207	89407	
			OIO	83207	89407	
75 - 80	C, M, S Chassis - Conventional Cab	4975510	OIO	83221
76 - 89	C, M, S Chassis - Conventional Cab	22002294 22007752 22012096 22012169	OIO	83304
			OIO	83304
				OIO	83221	...
				OIO	83221	...
73 - 80	C, S Chassis - Conventional Cab and School Bus	22012096 3192892		OIO	83221	...
				OIO	83221	...
73 - 89	C, S Chassis - Conventional Cab and School Bus	22012095 22012166		OIO	83126	89430
				OIO	83126	89430
63 - 69	C-50, M-50, S-50, SE-50, T-50 Models	OIO	85005	89430	OIO	83221	...
68	Cowl - Exc. School Bus	22012096 3192892	OIO	83221
			OIO	83221
69 - 70	D-D Forward Control with 9000 & 11000 lb Axles - Exc. Tilt Cab	22012096 3192892	OIO	83221
			OIO	83221
69 - 70	D-D Forward Control with Tilt Cab	22012095 4940606	OIO	83126	89430	
			OIO	83126	89430	
69 - 72	S-50 School Bus	3192892		83221	...	OIO	83221	...
				OIO	83126	89430
73 - 78	S-50 School Bus	22012166 3192892		OIO	83221	...
				OIO	83221	...
67 - 68	TDM 4 Cycle Detroit Diesel with Tandem Axle - Exc. Tilt Cab	22012096 3192892		OIO	83221	...
				OIO	83221	...
71 - 72	TDM 4 Cycle Detroit Diesel with Tandem Axle - Exc. Tilt Cab	22012095 4940606		OIO	83126	89430
				OIO	83126	89430

6, 60, 6000 & 6500 Series

69 - 72	All - Exc. Tilt Cab	22012096 3192892		83221	...	OIO	83221	...
				83221	...	OIO	83221	...
68 - 69	All with 9000 & 11000 lb Axles - Exc. Tilt Cab	22012095 4940606	OIO	83126	89430	
			OIO	83126	89430	
79 - 89	B6P042 School Bus (Axle codes F070, F070D)	22002294 22007752	OIO	83304
			OIO	83304
79 - 89	B6P042 School Bus (Axle codes F090, F120D)	22002295	OIO	83303

APPLICATION GUIDE - TRUCKS, TRAILERS, AND BUSES





Year Año Année	Model Modelo Modèle	OEM #	Front		Rear	
						
					Fleetline	GasSLX

CHEVROLET TRUCK (ALSO SEE GMC TRUCK)(Cont'd.)

6, 60, 6000 & 6500 Series(Cont'd.)

79 - 89	B6P042 School Bus (Axle codes F090, F120D)	22007753	010	83303
		22017531	010	83303
79 - 89	B6P042 School Bus w/15000 lb or 17000 lb Rear Springs	22012096		010	83221	...
		22012169		010	83221	...
79 - 89	B6P042 School Bus w/18500 or 20800 lb Rear Springs	22012095		010	83126	89430
		22012166		010	83126	89430
76 - 89	C, M Chassis - Conventional Cab	22002294	010	83304
		22007752	010	83304
75 - 80	C, M, S Chassis - Conventional Cab and School Bus	4975510	010	83221
73 - 75	C, M, S Chassis - Conventional Cab and School Bus with 5000 & 7000 lb Axle	22007750	010	83207	89407	
		4975467	010	83207	89407	
		4975494	010	83207	89407	
73 - 89	C, S Chassis - Conventional Cab and School Bus - Exc. with 20800 & 23000 lb Rear Axle	22012096		010	83221	...
		22012169		010	83221	...
		3192892		010	83221	...
73 - 89	C, S Chassis - Conventional Cab and School Bus with 20800 & 23000 lb Rear Axles	22012095		010	83126	89430
		22012166		010	83126	89430
		4940606		010	83126	89430
79 - 89	C, S Chassis - Conventional Cab and School Bus	22002295	010	83303
		22007753	010	83303
		22017530	010	83303
		22017531	010	83303
73 - 80	C, S, T Chassis - Conventional & Tilt Cab and School Bus with 5000 & 7000 lb Axle	22002293	010	83126	89430	
		22007701	010	83126	89430	
		22007751	010	83303
		22012095	010	83126	89430	
		3192890	010	83126	89430	
		4940606	010	83126	89430	
		4940662	010	83126	89430	
4975497	010	83126	89430			
71 - 72	Conventional Cab & Tilt Cab with 9000 & 11000 lb Axles	22012095		010	83126	89430
		4940606		010	83126	89430
68	Cowl - Exc. School Bus	22012096	010	83221
		3192892	010	83221
69 - 70	D - D Forward Control with 9000 & 11000 lb Axles - Exc. Tilt Cab	22012096	010	83221
		3192892	010	83221
76 - 89	S Chassis - School Bus	22002294	010	83304
		22007702	010	83304
		22007752	010	83304
69 - 78	S-60	3192892		83221	...	010	83221	...
		4975510		83221	...	010	83221	...
73 - 78	S-60 w/Air Brakes	22007701		010	83126	89430
		22007751		010	83303	...
		22012095		010	83126	89430
		22012166		010	83126	89430
		3171069		010	85304	...
		4940606		010	83126	89430
73 - 75	SE, SS-60 thru Serial # 134487 (1975 1st Design)	22007700	010	83207	89407	

APPLICATION GUIDE - TRUCKS, TRAILERS, AND BUSES

Year Año Année	Model Modelo Modèle	OEM #	Front		Rear	
						
			Fleetline	GasSLX	Fleetline	GasSLX

CHEVROLET TRUCK (ALSO SEE GMC TRUCK)(Cont'd.)



6, 60, 6000 & 6500 Series(Cont'd.)

73 - 75	SE, SS-60 thru Serial # 134487 (1975 1st Design)	22007750 4975467 4975494	010	83207	89407	
			010	83207	89407	
			010	83207	89407	
76 - 78	SE-60 From Serial # 120000 (1976 2nd Design)	22002294 22007752	010	83304
			010	83304
76 - 78	SE-60 w/Hydraulic Brakes from Serial # 120000 (1975 2nd Design)	22012169 3192892		010	83221	...
				010	83221	...
73 - 74	SG, SM-60	3192890	010	83126	89430	
73 - 74	SG, SM-61	4940606	010	83126	89430	
73 - 74	SG, SM-62	22002293	010	83126	89430	
73 - 74	SG, SM-63	22007701	010	83126	89430	
73 - 74	SG, SM-64	22007751	010	83303
60 - 62	Standard and Heavy Duty Truck and School Bus (2 Ton)	010	83221	...
71 - 72	TDM 4 Cycle Detroit Diesel with Tandem Axle	22012095 4940606		010	83126	89430
				010	83126	89430
67 - 68	TDM 4 Cycle Detroit Diesel with Tandem Axle - Exc. Tilt Cab	22012096 3192892		010	83221	...
				010	83221	...
79 - 80	W Chassis - 72" BBC Steel Tilt Cab	22002293 22007751	010	83126	89430	
			010	83303

7, 70 & 7000 Series

66 - 72	72" BBC Steel Tilt Cab with V-6 2 Cycle Diesel Engine	22012095 3171462 3192890	010	83126	89430	
			010	83126	89430	
			010	83126	89430	
66 - 72	72" BBC Steel Tilt Cab with V-6 2 Cycle Diesel Engine with 17201 and 17221 Axle	22012096 3192892		010	83221	...
				010	83221	...
66 - 72	72" BBC Steel Tilt Cab with V-6 2 Cycle Diesel Engine with 19101 and 19201 Axle	4940600		010	83209	89414
66 - 72	92" BBC Conventional Cab	3192657 4940614 4963854	010	83216
			010	83216
			010	83216
79 - 89	C, M Chassis - 97" BBC Conventional Cab	22002294 22002295 22007752 22007753	010	83304
			010	83303
			010	83304
			010	83303
		22012095 22012166 22017530 22017531		010	83126	89430
				010	83126	89430
			010	83303
010	83303			
66 - 72	Conventional Cab with Tapered 2-Leaf Softride 11000 lb Rating and F120 Axle (12000 lb)	22046483 22052336 3171069	010	85304
			010	85304
			010	85304
66 - 72	Conventional Cab With Tapered 2-Leaf Softride 7000 & 9000 lb Rating and F070, F090, F120 Axle (7000, 9000 & 12000 lb)	3171068 3192657 4940614 4963853 4963854	010	83216
			010	83216
			010	83216
			010	83216
			010	83216
77 - 80	H, J Chassis - 92" BBC Conventional Cab	4963854 4984526	010	83216
			010	83216

APPLICATION GUIDE - TRUCKS, TRAILERS, AND BUSES

Year Año Année	Model Modelo Modèle	OEM #	Front		Rear	
						
			Fleetline	GasSLX	Fleetline	GasSLX

CHEVROLET TRUCK (ALSO SEE GMC TRUCK)(Cont'd.)

7, 70 & 7000 Series(Cont'd.)

73 - 80	H, J Chassis - 92" BBC Conventional Cab with V-6, V8 Diesel Engines	4940614	010	83216
		4963854	010	83216
73 - 80	H, J, M Chassis - 92" & 114" BBC Conventional Cab	2204683	010	85304
		3171069	010	85304
73 - 80	R Chassis - Rear Engine Bus	22012090	010	85308	89422	
		5552451	010	85308	89422	
		5552456		010	85307	...
		5552552		010	85303	89422
83 - 84	S7T042 Forward Control Chassis w/17000, 18500, 21000, 23000 lb Rear Axle	22012095		010	83126	89430
		22012166		010	83126	89430
83 - 84	STT042 Forward Control Chassis	22012065	010	85304
		3171069	010	85304
73 - 80	T, W Chassis - 72" BBC Steel Tilt Cab (4 x 2) with V-6 Diesel Engine	22007751	010	83303
		22012095	010	83126	89430	
		4940606	010	83126	89430	
		4975497	010	83126	89430	
73 - 80	T, W Chassis - 72" BBC Steel Tilt Cab with V-6 Gas Engine	22012091	010	85303	89422	
		5552452	010	85303	89422	





8, 80 & 8000 Series

66 - 69	72" BBC Steel Tilt Cab	5544060	010	85302	89420	
66 - 72	92" BBC Conventional Cab	3171068	010	83216
		3192657	010	83216
		4940614	010	83216
		4963853	010	83216
		4963854	010	83216
66 - 72	92" BBC Conventional Cab with 7000 & 9000 lb Axles - Exc. 2-Leaf Softride	22046483	010	85304
		22052336	010	85304
		3171069	010	85304
79 - 82	H, J Chassis - 92" BBC Conventional Cab 4 x 2 with Air Suspension	22012065		010	85304	...
		22046483		010	85304	...
		22052336		010	85304	...
		3171069		010	85304	...
73 - 81	H, J Chassis - 92" BBC Conventional Cab	4940614	010	83216
		4963854	010	83216
		4984526	010	83216
73 - 86	H, J, M Chassis - 92" & 114" BBC Conventional Cab	22046483	010	85304
		22052336	010	85304
		3171069	010	85304
73 - 80	R Chassis - Rear Engine Bus	22012090	010	85308	89422	
		22012091		010	85303	89422
		5552451	010	85308	89422	
		5552452		010	85303	89422
		5552456		010	85307	...
70 - 80	T, W Chassis - 72" BBC Steel Tilt Cab with V-6 Gas Engine	22012091	010	85303	89422	
		5552452	010	85303	89422	

9000 Series

70 - 72	54" BBC Aluminum Tilt Cab 6 x 4	22046483		85304	...	010	85304	...
		22052336		85304	...	010	85304	...

APPLICATION GUIDE - TRUCKS, TRAILERS, AND BUSES

Year Año Année	Model Modelo Modèle	OEM #	Front			Rear		
								
				Fleetline	GasSLX		Fleetline	GasSLX

CHEVROLET TRUCK (ALSO SEE GMC TRUCK)(Cont'd.)

9000 Series(Cont'd.)

70 - 72	54" BBC Aluminum Tilt Cab 6 x 4	3171069		85304	...	010	85304	...
70 - 72	92" & 114" BBC Conventional Cab - Exc. 6 x 4	4940614	010	83216
		4963854	010	83216
70 - 72	92" & 114" BBC Conventional Cab 6 x 4	22046483		85304	...	010	85304	...
		22052336		85304	...	010	85304	...
		3171069		85304	...	010	85304	...
70 - 86	D, F Chassis - 54" BBC Aluminum Tilt Cab with Rear GM Air Ride Suspension (4 Req'd)	22012065		85304	...	010	85304	...
		22046483		85304	...	010	85304	...
		22052336		85304	...	010	85304	...
		3171069		85304	...	010	85304	...
70 - 86	H, J Chassis - 92" BBC Conventional Cab	22046483	010	85304
		22052336	010	85304
		3171069	010	85304
77 - 86	M, N Chassis - 114" BBC Conventional & 108" BBC Aluminum Conventional Cab with Rear GM Air-Ride Suspension (4 Req'd)	22012065		85304	...	010	85304	...
		22046483		85304	...	010	85304	...
		22052336		85304	...	010	85304	...
		3171069		85304	...	010	85304	...
70 - 80	T, W Chassis - 72" BBC Steel Tilt Cab	22012091	010	85303	89422	
		5552452	010	85303	89422	



B - Series - School Bus

90 - 98	B6, B7 Model School Bus Chassis With 11000, 13500, 15000 lb Taperleaf Springs With 15000, 19000, 21000 lb Multileaf Springs	22064231		- -	85324	...
		15174902		- -	85071	...
		22064232		- -	85071	...
	Models with O.E.M. Number	15123676	- -	83136
		15588554	- -	83136
		22064230	- -	83136
		88982682	- -	83136

C - Series (C4500, C5500) Kodiak

90 - 09	C Chassis - Conventional Cab Front Shock with O.E.M. Number	15123676	- -	83136
		15588554	- -	83136
		15887728	- -	83136
		19152843	- -	83136
		22064230	- -	83136
		88982682	- -	83136
		15174902		- -	85071	...
		22064232		- -	85071	...
		88982686		- -	85071	...
		04 - 09	C Chassis - Conventional Cab (Non 4x4 Option) with 13,500 Multi-leaf Spring	15185644		010
508-89				010	83155	...
L-12706				010	83155	...
90 -	C Chassis - Conventional Cab w/11000, 13500, 15000 lb Taperleaf Springs	22064231		- -	85324	...
90 - 06	C Chassis - Conventional Cab w/16900 or 17850 lb Taperleaf Springs	21998392		- -	85336	...
		22064489		- -	85336	...
		88963409		- -	85336	...
90 -	C Chassis - Conventional Cab w/19000, 21000, 23000 lb Taperleaf Springs (EXC Low Profile Vehicle)	22064233		- -	83136	...

APPLICATION GUIDE - TRUCKS, TRAILERS, AND BUSES

Year Año Année	Model Modelo Modèle	OEM #	Front		Rear	
						
			Fleetline	GasSLX	Fleetline	GasSLX

CHEVROLET TRUCK (ALSO SEE GMC TRUCK)(Cont'd.)

C - Series (C4500, C5500) Kodiak(Cont'd.)

83 - 99	C Chassis - Conventional Cab with 9100 to 17500 lb Rear Axle	22064432		010	85050	...
03 - 09	C Chassis - Conventional Cab with Taperleaf Rear Suspension	15185643		010	83153	...
	Models with O.E.M. Number	88982684	- -	83136
		88982688		- -	85336	...

C - Series (C6500, C7500, C8500) Kodiak

04 - 08	Conventional Cab (Low Profile) with 12000, 15000, & 17000 lb Leaf Spring	15174901		- -	85342	...
		507-22		- -	85342	...
		88982685		- -	85342	...
90 - 09	Conventional Cab w/ Front Shock with O.E.M. Number	15123676	- -	83136
		15174898	- -	83136
		15588554	- -	83136
		15887728	- -	83136
		19152843	- -	83136
		22064230	- -	83136
		88982682	- -	83136
90 -	Conventional Cab w/11000, 13500, 15000 lb Taperleaf Springs	22064231		- -	85324	...
90 - 09	Conventional Cab w/15000, 19000, 21000 lb Multileaf Springs	15174902		- -	85071	...
		22064232		- -	85071	...
		88982686		- -	85071	...
90 - 06	Conventional Cab w/16900 or 17850 lb Taperleaf Springs	21998392		- -	85336	...
		22064489		- -	85336	...
		88963409		- -	85336	...
90 -	Conventional Cab w/19000, 21000, 23000 lb Taperleaf Springs (EXC Low Profile Vehicle)	22064233		- -	83136	...
04 - 08	Conventional Cab with 19000 lb Leaf Spring	15174903		- -	85342	...
		507-23		- -	85342	...
		88982687		- -	85342	...
83 - 99	Conventional Cab with 9100 to 17500 lb Rear Axle	22064432		010	85050	...
95 - 02	Models with Hendrickson Air Suspension (Stamping number 47902-13)	12474915		010	83122	89406
		15963161		010	83122	89406
96 - 02	Models with Hendrickson Air Suspension (Stamping number 47902-29)	12474917		010	83137	...
		15740554		010	83137	...
	Models with O.E.M. Number	88982684	- -	83136
		88982688		- -	85336	...

P - Series

92 - 96	Motorhome Chassis	22064231		- -	85324	...
		22064233		- -	83136	...

T - Series (T5500, T6500, T7500, T8500)

97 -	FL1 Tilt Cab with 8100 lb Axle	22064804	- -	83136
		22064805	- -	83136
		22165187	- -	83136
		22165188	- -	83136
97 -	FL2 Tilt Cab with 5000 to 11000 lb Axle	22064807	- -	83136
		22166442	- -	83136
97 -	FL3 Tilt Cab with 14575 lb Axle	22064806	- -	83136
		22165189	- -	83136
99	Models with Hendrickson Air Suspension (Stamping number 47902-13)	12474915		010	83122	89406
		15963161		010	83122	89406
90 - 99	Tilt Cab w/11000, 13500, 15000 lb Taperleaf Springs	22064231		- -	85324	...

APPLICATION GUIDE - TRUCKS, TRAILERS, AND BUSES

Year Año Année	Model Modelo Modèle	OEM #	Front		Rear	
			Fleetline	GasSLX	Fleetline	GasSLX

CHEVROLET TRUCK (ALSO SEE GMC TRUCK)(Cont'd.)

T - Series (T5500, T6500, T7500, T8500)(Cont'd.)

90 - 06	Tilt Cab w/15000, 19000, 21000 lb Multileaf Springs	15174902 22064232		- -	85071	...
				- -	85071	...
92 - 06	Tilt Cab w/16900 lb Taperleaf Springs	21998392 22064489 88963409		- -	85336	...
				- -	85336	...
				- -	85336	...
92 - 99	Tilt Cab w/19000, 21000, 23000 lb Taperleaf Springs (EXC Low Profile Veh.)	22064233		- -	83136	...
06 - 09	Tilt Cab Models with O.E.M. Number	15174901		- -	85342	...
		15174903		- -	85342	...
		507-22		- -	85342	...
		507-23		- -	85342	...
		88982685		- -	85342	...
		88982687		- -	85342	...





W - Series (Isuzu)

83 - 95	W4 Models	9-51630-666-0		o o	85012	89413
		9-51630-666-2		o o	85012	89413
86 - 90	W4 Models	8-94454-986-0	- o	83515
		8-94454-987-0	- o	83515
		9-51630-647-1	- o	83515
89 - 90	W4 Models Flatlow	9-51630-647-1	- o	83515
89 - 92	W4 Models Flatlow	9-51630-666-0		o o	85012	89413
		9-51630-666-2		o o	85012	89413
86 - 95	W4 Models with 11000 lb Suspension	97083027	- o	83515
87 - 95	W4 Models with 13000 lb Suspension	94454987	- o	83515
		97083029	- o	83515
88 - 97	W5 Models	1-51630-217-0	- o	83114
		1-51630-217-1	- o	83114
		1-51630-219-1	- o	83114
86 - 91	W6 Models	1-51630-168-1	- o	83515
		1-51630-217-0	- o	83114
		1-51630-217-1	- o	83114
	Models with O.E.M. Number	8-94057-593-0	- o	83114
		8-97201-960-0	- o	83515
		94033786	- o	83114
		94051090	- o	83114
		94057593	- o	83114
		97201960	- o	83515

Additional O.E.M. Interchanges

	Models with O.E.M. Number	15642943		- -	83136	...	
		22046489		o o	85303	89422	
		22065218		o o	G63347	
		22065251		o o	85030	89440	
		22099889			- -	85336	...
		507-24			- -	85336	...
		508-86			- -	83136	...
		508-88			o o	83153	...
	Additional O.E.M. Interchanges	22007703	o o	83303					
		22012067	o o	85700					
		22012079	- -	85701					
		22012082	o o	85702					
		22012083	- o	85711					

APPLICATION GUIDE - TRUCKS, TRAILERS, AND BUSES





Year Año Année	Model Modelo Modèle	OEM #	Front		Rear	
						
				Fleetline		GasSLX

CHEVROLET TRUCK (ALSO SEE GMC TRUCK)(Cont'd.)

Additional O.E.M. Interchanges(Cont'd.)

Additional O.E.M. Interchanges	OEM #	Interchange Code	Interchange Code
	22012114	010	85700
	22012131	-10	85711
	22024062	-1-	85701
	22024673	-10	85710
	22045526	010	85702
	22046481	010	85702
	22046485	-10	85710
	22046499	-10	85710
	22052014	010	85702
	22052424	-10	85710
	3171696	010	85307
	3172948	010	85303 or 89422
	3175509	010	85735
	3178157	010	85700
	3178233	010	85734
	3178507	010	85700
	3178995	010	85700
	3188626	010	85300 or 89419
	3188729	010	85303 or 89422
	4939852	010	85308 or 89422
	4939967	010	85308 or 89422
	4940601	010	83216
	4940627	010	83203 or 89436
	4940640	010	83216
	4940650	010	83207 or 89407
	4940654	010	83216
	4940660	010	83207 or 89407
	4963844	010	85307
	4964853	010	83217
	4974401	010	85700
	4975429	010	85300 or 89419
	4975479	-1-	83400
	4975480	-1-	83400
	4975515	-1-	85701
	4975516	010	85702
	4975518	010	85704
	4975538	010	85700
	4975549	010	83216
	4975550	010	85702
	507-3	010	85307
	5171068	010	83216
	5316784	010	85700
	5316791	010	83219
	5316792	010	85305
	5316793	010	85305
	5321920	010	85307
	5321929	010	85307
	5348631	010	83203 or 89436
	5352858	010	85305
	5353054	010	85303 or 89422
	5355798	010	85307

APPLICATION GUIDE - TRUCKS, TRAILERS, AND BUSES





Year Año Année	Model Modelo Modèle	OEM #	Front		Rear	
						
			Fleetline	GasSLX	Fleetline	GasSLX

CHEVROLET TRUCK (ALSO SEE GMC TRUCK)(Cont'd.)

Additional O.E.M. Interchanges(Cont'd.)

Additional O.E.M. Interchanges	OEM #	Interchange #
	5357955	85300 or 89419
	5357956	85734
	5357959	85300 or 89419
	5361994	85734
	5374779	85308 or 89422
	5374999	85307
	5385939	85307
	5392387	85303 or 89422
	5394448	85305
	5394467	85305
	5394468	85735
	5455798	85307
	5513489	83216
	5513716	85304
	5516459	85305
	5522781	85735
	5522794	85308 or 89422
	5522818	85305
	5527001	85300 or 89419
	5527271	85700
	5527272	85700
	5527606	85305
	5531027	85301
	5531435	85307
	5531436	85307
	5531437	85307
	5532026	85304
	5532425	83207 or 89407
	5532433	83207 or 89407
	5532675	85307
	5534430	85303 or 89422
	5534439	85304
	5534447	85303 or 89422
	5544112	83216
	5544581	85302 or 89420
	5544716	85304
	5544717	85304
	5544812	83308
	5544818	85735
	5549899	83207 or 89407
	5549924	85700
	5549925	85304
	5552111	85304
	5552112	85307
	5552114	83216
	5552205	83217
	5552206	83214
	5552207	83217
	5552208	83217
	5552209	83215
	5552210	85308 or 89422

APPLICATION GUIDE - TRUCKS, TRAILERS, AND BUSES

Year Año Année	Model Modelo Modèle	OEM #	Front		Rear	
						
			Fleetline	GasSLX	Fleetline	GasSLX

CHEVROLET TRUCK (ALSO SEE GMC TRUCK)(Cont'd.)

Additional O.E.M. Interchanges(Cont'd.)

Additional O.E.M. Interchanges	5552244	010	85308 or 89422
	5552285	010	83214
	5552286	010	83217
	5552287	010	83217
	5552288	010	83217
	5552453	010	85301
	5552527	010	85735
	5554184	010	85302 or 89420
	5554589	010	85307
	5554596	010	85303 or 89422
	5554814	010	85302 or 89420
	5554959	010	83401
	5554995	010	85305
	5559363	010	83203 or 89436
	5585939	010	85307
	684280	010	83209 or 89414
	97-2210-00153	-1-	85701
	97-2210-00164	-1-	85708
97-2210-00170	01-	85733	

CHEVROLET TRUCK CAB SHOCKS

	Bruin Tractors with J9 Cabs with Link Cabmate Model GMC92J9	1202-0012	010	83023
90 -	Kodiak Truck Cabs with Link Cabmate Model GMC104TK	1202-0054	010	83021
- 89	Kodiak Truck Cabs with Link Cabmate Model GMC92TK	1202-0012	010	83023
	Models with Link Cab Suspension	1202-0022	010	83046
	Titan Cabover (Sleeper & Non-Sleeper Trucks) with Link Cabmate Model GMC-2P-A	1202-0032	010	83016

CHRYSLER

Motorhome Chassis

73 - 81	M & R-300, 400, 500 Motorhome Chassis	3638112		010	G63183	...
63 - 72	M-300, M-375 & R-375 Motorhome Chassis	2961043		010	G63183	...
		3633744		010	G63183	...

CLARK EQUIPMENT

	Model 130885 (Air Suspension)	5532675		010	85307	...
	Ross Carrier	355778		85315	...	010	85315	...
		680042		85301	...	010	85301	...

CNH GLOBAL N V









	Models with O.E.M. Number	87019546	010	83022
		87268250	010	83021

COACHMEN RV

Class A MotorHomes

03 - 05	Cross Country Elite & SE Series MotorHomes with Freightliner XC Chassis							
	ADL200 Suspension w/ 20K Rear	16-16873-000		010	85029	...
	AS120 Front Suspension	141700131810	010	83160
		16-16737-000	010	83160
		16-16874-000	010	83160

APPLICATION GUIDE - TRUCKS, TRAILERS, AND BUSES

Year Año Année	Model Modelo Modèle	OEM #	Front		Rear	
						
						
			Fleetline	GasSLX	Fleetline	GasSLX

COACHMEN RV(Cont'd.)

Class A MotorHomes(Cont'd.)

	Rear Shock with O.E.M. Number	141700131809		010	85029	...
		16-16736-000		010	85029	...
	ZF - IFS Front Suspension with 23,000 lb GVW or Greater	16-18103-000	- -	85900
		481700000493	- -	85900
06	Cross Country Series MotorHomes with Freightliner XC Chassis							
	ADL200 Suspension w/ 20K Rear	16-16873-000		010	85029	...
	AS120 Front Suspension	141700131810	010	83160
		16-16737-000	010	83160
		16-16874-000	010	83160
	Rear Shock with O.E.M. Number	141700131809		010	85029	...
		16-16736-000		010	85029	...
	ZF - IFS Front Suspension with 23,000 lb GVW or Greater	16-18103-000	- -	85900
		481700000493	- -	85900

CONTINENTAL TRAILWAYS-EAGLE INT'L

	Buses with O.E.M. Number	01-0100-020		85307	...	010	85307	...
		5532026		85304	...	010	85304	...
		6-05-5		85307	...	010	85307	...
	Silver Eagle	01-0100-905		85303	...	010	85303	89422
		5394467		85305	...	010	85305	...
		680091		85303	...	010	85303	89422
		70039		85303	...	010	85303	89422
		70041		85305	...	010	85305	...

COUNTRY COACH

	Models with O.E.M. Number	89406	010	...	89406	
		89414		010	...	89414

CRANE CARRIER

	Models with O.E.M. Number	277A-1	010	85307
		277A-13	010	85302	89420	
		277A-14	010	85304
		277A-8	010	85303	89422	
		277A-9	010	85307
		680091	010	85303	89422	
	Additional O.E.M. Interchanges	277A-12	010	85304				
		680088	010	85713				

CROWN COACH

	All with Steel Spring Suspension	3188729	010	85303	89422	
		5532026		85304	...	010	85304	...
	Models with O.E.M. Number	5532036		85734	...	010	85734	...

CUNHA PRODUCTS OHD

	Truck Dollies	CP-5222		010	85315	...
--	---------------	---------	--	-----	-----	-----	--------------	-----

DANA

	Dana Smart Ride - RF and RS Models - 20,000 lb and 23,000 lb	SR1VJ100		010	85078	...
--	--	----------	--	-----	-----	-----	--------------	-----

APPLICATION GUIDE - TRUCKS, TRAILERS, AND BUSES

Year Año Année	Model Modelo Modèle	OEM #	Front		Rear	
			 Fleetline	 GasSLX	 Fleetline	 GasSLX

DEXTER AXLE

Trailer

	86 AR / RS 1015, 1035, 3035 Slider Air Suspension	18165-01		OIO	85006	...
--	---	----------	--	-----	-----	-----	--------------	-----

DIAMOND T

	Models with O.E.M. Number	5549925	OIO	85304
--	---------------------------	---------	-----	--------------	-----	--	-----	-----

DIAMOND-REO

	All w/Velvet Ride Suspension	OIO	85307	...
	C054, C088 w/FH or FL Axle	OIO	85307
	C054, C088, C114, C116 w/FF Axle	220-55-1	OIO	83214
		220-55-6	OIO	83214
	C090, C090D, C101	220-55-2	OIO	85304
		220-55-7	OIO	85304
	C114, C116 w/FH or FL Axle	220-55-2	OIO	85304
		220-55-7	OIO	85304
	CF Models	220-55-8	OIO	83217
	DC101	220-55-2	OIO	85304
		220-55-7	OIO	85304
	Additional O.E.M. Interchanges	220-S5-10		OIO	85712	...

DINA BUS

	F Models Coaches with O.E.M. Number (Drive Axle)	39390339-6		OIO	85307	...
	Marco Polo Viaggio GV 1000							
	Front Shock	39380353-6	OIO	85716
	Tag Axle	39390340-4		OIO	85716	...
11 - 13	Outsider Buses	1520030010		-IO	83317	...
		152E030030	OIO	85014
	P Chassis with O.E.M. Number (Drive Axle)	39390339-6		OIO	85307	...
11 - 13	Picker Buses	1520030010		-IO	83317	...
		152E030030	OIO	85014
11 - 13	Runner 10E Buses	1520030010		-IO	83317	...
		152E030030	OIO	85014
11 - 13	Runner 8, 9 & 10 Buses	1520030010		-IO	83317	...
		152E030030	OIO	85014

DODGE TRUCK

D Series- Conventional Cab 4 x 2

74 - 78	D-500, D-600, D-700, D-800	3633643		OIO	G63183	...
73	D-500, D-600, D-800	2516009		OIO	G63183	...

LN & LNT - Conventional Cab

64 - 72	LN, LV Models	2516009		OIO	G63183	...
----------------	---------------	---------	--	-----	-----	-----	---------------	-----

LNT, LVT, NLT, VLT- Tilt Cab 6 x 4

64 - 73	LNT, LVT Models	2516009		OIO	G63183	...
----------------	-----------------	---------	--	-----	-----	-----	---------------	-----

LS & LT-Steel Tilt Cab

73 - 75	LS-1000, LT-1000	2516009		OIO	G63183	...
----------------	------------------	---------	--	-----	-----	-----	---------------	-----

Motorhome Chassis

73 - 81	M & R-300, 400, 500 Motorhome Chassis	3638112		OIO	G63183	...
		3638631	OIO	G63605
63 - 72	M-300, M-375 & R-375 Motorhome Chassis	2961043		OIO	G63183	...
		3633744		OIO	G63183	...
77 - 81	M-6 Motorhome Chassis	3638112		OIO	G63183	...
		4036892	OIO	G63605

APPLICATION GUIDE - TRUCKS, TRAILERS, AND BUSES

Year Año Année	Model Modelo Modèle	OEM #	Front			Rear		
			Fleetline	GasSLX		Fleetline	GasSLX	

DODGE TRUCK(Cont'd.)

P Series - Forward Control(Cont'd.)

72 - 82	P-300	010	G63183	...
63 - 78	P-400	010	G63183	...
63 - 71	PC-500 and PC-600, PD-500 and PD-600	010	G63183	...

School Buses

61 - 71	S-400, S-500, S-600	010	G63183	...
72 - 73	S-500, S-600	2516009		010	G63183	...
74 - 78	S-600, S-700	3633643		010	G63183	...

W-Series And Power Wagons

61 - 72	W-500, WT-500 Models	010	G63183	...
73	W-600 Models	2516009		010	G63183	...
				2960707	010	G63183
74 - 78	W-600 Models	3633643		010	G63183	...

DUPLEX TRUCK

	Models with O.E.M. Number	59024		83204	...	010	83204	...
		7604-3371		83204	...	010	83204	...

DURA SUSPENSION

	Models with O.E.M. Number	1080099		010	83203	89436
		12866		010	83207	89407
		59024		010	83204	...
		59030		010	83203	89436
		665133		010	83203	89436
		665267		010	85029	...
		7604-3371		010	83204	...
		A-2212		010	85029	...









EAGLE MOTOR COACH

	Buses with Rubber Torsion Suspension	6-05-5		010	85307	...
	Buses with Steel Spring Suspension	5532026		85304	...	010	85304	...
	Models with O.E.M. Number	01-0100-020	010	85307	...	010	85307	...
		01-0100-905		85303	...	010	85303	89422
		014-0100-905		85308	89422
		101364		85305	...	010	85305	...
		154-0100-514		85314	89425
		5394467		85305	...	010	85305	...
		680091		85303	...	010	85303	89422
		70039		85303	...	010	85303	89422
	70041			85305	...	010	85305	...
	Additional O.E.M. Interchanges	0140100-905	010	85308 or 89422				
		12B-5-1	010	85735				
		12J-5-10	01-	85733				
		690060	010	85713				

EAST MANUFACTURING CORP.

Identification of the trailer suspension is necessary to determine what section of the catalog to refer to. Some possible options can be Chalmers, Hendrickson, Neway, Ridewell, Reyco.								
	Shocks with stamping number	A-20002		010	85000	89436
		A-20126		010	85323	89436
	Trailers with East Trailer part number	517-05001-18		010	87015	...
		517-05001-23		010	85005	89430

APPLICATION GUIDE - TRUCKS, TRAILERS, AND BUSES

Year Año Année	Model Modelo Modèle	OEM #	Front		Rear	
						
						
			Fleetline	GasSLX	Fleetline	GasSLX

EAST MANUFACTURING CORP.(Cont'd.)

	Trailers with East Trailer part number	517-05006-20		OIO	85030	89440	
			517-05009-14		OIO	83125	...
			517-05010-07		OIO	83214	...
			517-05022-07		OIO	83217	...
			517-05110-20		OIO	85000	89436
			517-05511-14		OIO	83128	...
			517-05805-20		OIO	85000	89436
			517-05806-20		OIO	85029	...
			517-05808-20		OIO	85738	...
			517-05809-20		OIO	...	89437
			517-05916-14		OIO	83124	89407

ELDORADO NATIONAL

02 - 13	40 Foot Low Floor Buses with O.E.M	13208701		- -	85746	...
			13208801	- -	85745

FLEETWOOD RV

Class A MotorHomes

02 - 06	Bounder / Discovery & Expedition MotorHomes with Freightliner XC Chassis ADL200 Suspension w/ 20K Rear AS120 Front Suspension Rear Shock with O.E.M. Number ZF - IFS Front Suspension with 23,000 lb GVW or Greater	16-16873-000 141700131810 16-16737-000 16-16874-000 141700131809 16-16736-000 16-18103-000 481700000493		OIO	85029	...
			OIO	83160	
			OIO	83160	
			OIO	83160	
			OIO	OIO	85029	...
			OIO	OIO	85029	...
			- -	85900	
			- -	85900	
03 - 06	Excursion & Providence MotorHomes with Freightliner XC Chassis ADL200 Suspension w/ 20K Rear AS120 Front Suspension Rear Shock with O.E.M. Number ZF - IFS Front Suspension with 23,000 lb GVW or Greater	16-16873-000 141700131810 16-16737-000 16-16874-000 141700131809 16-16736-000 16-18103-000 481700000493		OIO	85029	...
			OIO	83160	
			OIO	83160	
			OIO	83160	
			OIO	OIO	85029	...
			OIO	OIO	85029	...
			- -	85900	
			- -	85900	





FLUIDRIVE

	Models T950-1200, -1400, -1700	2697		OIO	85712	...
--	--------------------------------	------	--	-----	-----	-----	-------	-----

FLXIBLE BUS

	29 Passenger & Vista Coach		83217	...	OIO	83217	...
	2-Level Intercity Bus		85736	...	OIO	85736	...
	City Bus - 51 Passenger	6-05-1	OIO	85736
		6-05-2	OIO	85736
		6-05-3	OIO	85736
		6-05-4	OIO	85736
		6-05-5	OIO	85307
		6-05-6	OIO	85736
		6-05-7	OIO	85736





APPLICATION GUIDE - TRUCKS, TRAILERS, AND BUSES

Year Año Année	Model Modelo Modèle	OEM #	Front		Rear	
						
			Wrench	Wrench	Wrench	Wrench
			Fleetline	GasSLX	Fleetline	GasSLX

FLXIBLE BUS(Cont'd.)

	City Bus - 51 Passenger	6-05-8	OIO	85736
	City Bus - 51 Passenger with Rubber Torsion Suspension	6-05-1		85736	...	OIO	85736	...
		6-05-2		OIO	85736	...
		6-05-3		OIO	85736	...
		6-05-4		OIO	85736	...
		6-05-5		OIO	85307	...
		6-05-6		OIO	85736	...
		6-05-7		OIO	85736	...
		6-05-8		OIO	85736	...
	CNG Bus (Natural Gas)	87-2519-00002	-IO	85731
		87-2519-00004	-IO	85731
		87-2520-00002		OIO	85730	...
		87-2520-00004		OIO	85730	...
		97-2201-00008		-IO	85731
		97-2210-00010		OIO	85730	...
	Model 870 Flex Bus, Metro	22024062	-IO	85701
		22024506	-IO	85703
		22025066	-IO	85703
		4975518		OIO	85704	...
		680320	-IO	85703
		74412		OIO	85704	...
		87-2519-00001	-IO	85703
		87-2519-00003	-IO	85703
		87-2520-00001		OIO	85704	...
		87-2520-00003		OIO	85704	...
		97-2201-00003	-IO	85703
		97-2201-00005	-IO	85703
		97-2201-00006	-IO	85703
		97-2201-00007	-IO	85703
		97-2201-00009	-IO	85703
		97-2210-00001		OIO	85704	...
		97-2210-00002		OIO	85704	...
		97-2210-00003		OIO	85704	...
		97-2210-00004		OIO	85704	...
	97-2210-00005		OIO	85704	...	
	97-2210-00006		OIO	85704	...	
	97-2210-00009		OIO	85704	...	
	97-2210-00011		OIO	85704	...	
	Models with O.E.M. Number	22012067		85700	...	OIO	85700	...
		22012114		85700	...	OIO	85700	...
		22024061		OIO	85704	...
		22025067		OIO	85704	...
		22025305		OIO	85704	...
		3166657		85700	...	OIO	85700	...
		3192333		85700	...	OIO	85700	...
		6-05-13		OIO	85304	...
		6-05-9	OIO	85304
		6-367-12		85700	...	OIO	85700	...
		6-367-14		85700	...	OIO	85700	...
		6-367-16		85700	...	OIO	85700	...
		6-367-8		85700	...	OIO	85700	...
		695125		OIO	85704	...

APPLICATION GUIDE - TRUCKS, TRAILERS, AND BUSES

Year Año Année	Model Modelo Modèle	OEM #	Front		Rear	
						
			Fleetline	GasSLX	Fleetline	GasSLX

FLXIBLE BUS(Cont'd.)

Models with O.E.M. Number	97-2201-00001	-10	85703
	97-2201-00002	-10	85703
	97-2201-00004	-10	85703
	97-2201-00151		85700	...	010	85700	...
	97-2210-00170		85733	...	01-	85733	...
	97-9999-02592	-10	85710
Additional O.E.M. Interchanges	015813	-1-				85708	
	06-0367-00151	010				85700	
	06-0367-00156	010				85702	
	06-0367-00157	-1-				85701	
	48-1-239	010				85736	
	48-1-241	010				85712	
	6-05-10	010				85734	
	6-367-1	-10				85711	
	6-367-11	-10				85711	
	6-367-17	010				85700	
	6-367-2	010				85736	
	6-367-3	010				85304	
	6-367-4	010				83217	
	6-367-6	-10				85711	
	6-367-7	010				85305	
	6-367-9	-10				85711	
	680029	010				85301	
	680155	010				85712	
	97-2210-00153	-1-				85701	
	97-2210-00156	010				85702	
	97-2210-00157	-1-				85708	
	97-2210-00160	-1-				85705 or 89447	
	97-2210-00162	-1-				85701	
	97-2210-00164	-1-				85708	
	97-9999-00732	-1-				85707	
	97-9999-00807	010				85307	
	97-9999-02514	010				85700	
	97-9999-02515	010				85702	
	97-9999-02516	-1-				85701	
	97-9999-02519	-1-				85707	
	97-9999-02595	010				85313	
97-9999-02632	-10				85711		
97-9999-02633	-10				85311 or 89424		
97-9999-02634	01-				85733		
97-9999-02635	010				85718		
97-9999-02636	010				85716		

FLYER INDUSTRIES

	Coaches with Low Floor	15813		-1-	85708	...
91 -	Coaches with Low Floor	009863	-1-	85722
	Additional O.E.M. Interchanges	015915	-10				85711	
		22012067	010				85700	
		22012114	010				85700	
		3166657	010				85700	
		3192333	010				85700	
	4975501	010				85700		

APPLICATION GUIDE - TRUCKS, TRAILERS, AND BUSES

Year Año Année	Model Modelo Modèle	OEM #	Front		Rear	
			Fleetline	GasSLX	Fleetline	GasSLX

FLYER INDUSTRIES(Cont'd.)

Additional O.E.M. Interchanges	4975552	- O					85711
	592-6568	O O					85700
	5979574	O O					85700

FORD





AeroMax (A, AT, AAT, 8500, 9500) Series

96	8000 Models with 12000 or 13000 lb Axles	F6HT-18045-LA	O O	85376	...				
96	8000 Models with 16000 lb. Multileaf Spring	F6HT-18045-AA	O O	85054	89438				
96 - 97	9500 (113" & 122" BBC) Models with 10000 lb Axle and 54" Multileaf Spring	F6HT-18045-KA	O O	83200	89402				
96 -	9500 (113" & 122" BBC) Models with 12000 or 13200 lb Axle and 54" Multileaf Spring	F6HT-18045-BC	O O	85047	89435				
96 - 97	9500 (113" & 122" BBC) Models with 8500 or 9000 lb Axle and 54" Taperleaf Spring	F6HT-18045-HC	O O	85054	89438				
96 -	All Models with 10000 lb or 12000 lb Axle and 54" Taperleaf Spring	F6HT-18045-AC	O O	85054	89438				
		F6HZ-18124-A	O O	85054	89438				
		F6HZ-18124-G	O O	85054	89438				
96 -	All with 12000 lb, 13000 lb or 14600 lb Axle and 60" Taperleaf Spring	F6HT-18045-EB	O O	85055	89439				
		F6HT-18045-EC	O O	85055	89439				
		F6HZ-18124-D	O O	85055	89439				
		F6HZ-18124-E	O O	85055	89439				
		F6HZ-18124-F	O O	85055	89439				
96 -	All with 13200 lb or 14600 lb Axle and 54" Taperleaf Spring	F6HT-18045-GB	O O	85030	89440				
		F6HT-18045-GC	O O	85030	89440				
96 -	All with 21000 lb or 23000 lb Axle and 46" Taperleaf spring	F5HZ-18125-B		O O	85001	89410	
96 -	All with 23000 lb Axle and 52" Taperleaf spring	F5HZ-18125-A		O O	85314	89425	
96 - 97	All with Hendrickson 40LH Model Tandem Axle	57241-2		O -	83109	...	
		F6HT-18080-B		O -	83109	...	
		F6HT-18080-DA		O -	83109	...	
		F6HZ-18125-B		O -	83109	...	
		47902-28		O O	85013	89414	
96 - 97	All with Hendrickson HAS-400, HA-210 or HA-230 Air Suspension	F6HZ-18080-FC		O O	85013	89414	
		F6HZ-18125-D		O O	85013	89414	
		90045068		- O	...	89441	
96 - 97	All with Neway AD-123 Air Suspension	F6HZ-18125-C		- O	...	89441	
		90045099		O O	85906	89407	
96 - 97	All with Neway AD-246 Air Suspension	90045132		O O	85909	...	

B - Series - Bus Cowl Chassis

61 - 79	B - 500, B - 600, B - 700, B - 750 Models	D2TF-18080-HA		O O	83225	...
		D7HT-18080-BA		O O	83225	...
70 - 79	B - 500, B - 600, B - 700, B - 750 Models	D2TF-18045-GA	O O	83308	...			
		D7HT-18045-GA	O O	83308	...			
61 - 69	B - 500, B - 600, B - 700, B - 750 with 4000, 4700 and 5000 lb Axle	- -	83400	...			
61 - 69	B - 500, B - 600, B - 700, B - 750 with 6000 & 7000 lb Axle	C2TA-18045-A	O O	83216	...			
86 - 89	B - 600, B - 700 Models with O.E.M. Number	ASH-24446		O O	83215	...
		AX-310		O O	83215	...
77 - 96	B - 600, B - 700, B - 750, B - 800, B - 7000 with 18500 lb Axle	D7HT-18080-AA		O O	83215	...
80 - 96	B - 600, B - 700, B - 800, B - 7000 Models	D7HT-18080-DA		O O	83215	...
		E0HT-18045-AA	O O	83309	89446			...
		E0HT-18045-AB	O O	83309	89446			...

APPLICATION GUIDE - TRUCKS, TRAILERS, AND BUSES

Year Año Année	Model Modelo Modèle	OEM #	Front		Rear	
						
			Fleetline	GasSLX	Fleetline	GasSLX

FORD(Cont'd.)

B - Series - Bus Cowl Chassis(Cont'd.)

80 - 96	B - 600, B - 700, B - 800, B - 7000 Models	E0HT-18080-AA F1HT-18045-AA	OIO	OIO	83215	...
				83309	89446			...
77 - 79	B - 600, B - 750, with 18500 lb Axle	D7HT-18080-DA		OIO	83215	...
94 - 97	B - 700, B - 800 with 14600 lb Multileaf Spring	F4HT-18045-EA	OIO	83125
94 - 97	B - 700, B - 800 with 15000, 17500, 19000 lb Taperleaf Springs	F4HT-18080-AA		OIO	85314	89425
		F4HT-18080-AB		OIO	85314	89425
94 - 97	B - 700, B - 800 with 21000 lb Taperleaf Springs	F4HT-18080-BA		OIO	85001	89410
94 - 97	B - 700, B - 800 with 52" Multileaf Spring	F4HT-18045-CB	OIO	83107

C & CT Series - Tilt Cab

71 - 73	C-500, C-550, C-600, C-650, C-700, C-750 with 6000 & 7000 lb Axle	D1TF-18045-LA	OIO	83312	89409	OIO	83215	...
				83309	89446			...
64 - 67	C-550, C-600 with 6000 lb Axle - and Power Steering	C2TA-18045-A	OIO	83216
64 - 67	C-550, C-600 with 6000 lb Axle - Exc. with Power Steering	C6PF-18077-A	OIO	G63306
64 - 67	C-550, C-600, C-650, C-700, C-750 Models	C6PF-18077-F		OIO	83225	...
67 - 69	C-600, C-650, C-700, C-750, C-800, C-850, C-1000 with 7000, 9000, 11000, 12000, 15000 lb Axles - Exc. with 175" Wheel Base	D2HF-18045-CA	OIO	83308
67 - 71	C-600, C-650, C-700, C-750, C-800, C-850, C-1000 with 7000, 9000, 11000, 12000, 15000 lb Axles and 175" Wheel Base	C8HA-18045-A	OIO	83312	89409	
80 - 90	C-600, C-700, C-7000, C-800, C-8000, CT-800, CT-8000 with 3100 lb Spring and 7000 lb Axle	D7HT-18045-JA	OIO	83308
76 - 79	C-600, C-700, C-750, C-800, C-900, CT-800, CT-900 Models	D2EF-18045-AA	OIO	83312	89409	
		D7KF-18045-EA	OIO	83312	89409	
80 - 90	C-600, C-700, C-800, C-7000, CT-800, CT-8000 with 4040, 5040 lb Springs and 7000, 9000, 12000 lb Axles	D2EF-18045-AA	OIO	83312	89409	
64 - 66	C700/1100, CT-700/1100 with 7000, 9000, 11000, 15000 lb Axles	D2HF-18045-CA	OIO	83308
69 - 79	C-750, C-800, C-850, C-900, CT-750, CT-800, CT-850, CT-900, CT-950 with 9000 lb to 15000 lb Axles	C8HA-18045-A	OIO	83312	89409	
		D1TF-18045-LA	OIO	83312	89409	
		D2KF-18045-AA	OIO	83312	89409	

CF Series (Brazilian Built)

86 - 89	CF - 600, CF - 700 Models	E5HT-18045-AA E5HT-18080-DA E5HT-18080-EA	OIO	85301	...	OIO	85315	...	
						85315	...
						85315	...
96 - 97	CF-7000, CF-8000 or CFT-8000 Models with 16000 lb. Multileaf Spring	F6HT-18045-AA	OIO	85054	89438		
92 - 97	CF-7000, CF-8000 or CFT-8000 Models with 9000 lb Axle	F2HT-18045-BA	OIO	85376	
		F2HT-18045-CA	OIO	85376	
		F2HZ-18124-A	OIO	85376	
		F6HT-18045-LA	OIO	85376	
86 - 97	CF-7000, CF-8000 with 12000 lb or 13000 lb Axle	OIO	85302	89420	
		87HU-18045-AA	OIO	85301	
		E5HT-18045-AA	OIO	85301	
		E6HZ-18124-A	OIO	85301	
		E7HZ-18124-A	OIO	85301	

CL & CLT Series - Highway Tractor Tilt Cab

78 - 89	CL-9000, CLT-9000 Models	D7HT-18045-NA	OIO	85301	...	OIO	83123	89405
90 - 91	CL-9000, CLT-9000 with Multileaf Spring	F1HT-18045-NA	OIO	85040	...			
78 - 89	CL-9000, CLT-9000 with Rear Tandem Axle with Neway Suspension	D7HA-18080-AA		OIO	83209	89414
78 - 89	CL-9000, CLT-9000 with Single Rear Axle Suspension	D4HA-18080-AA		OIO	83122	89406
	Models with Hendrickson Rear Air Suspension	47902-13		OIO	83122	89406

APPLICATION GUIDE - TRUCKS, TRAILERS, AND BUSES









Year Año Année	Model Modelo Modèle	OEM #	Front		Rear	
			Fleetline	GasSLX	Fleetline	GasSLX

FORD(Cont'd.)

F Series - Conventional Cab(Cont'd.)

64 - 66	F-1000 Models with 11000 lb to 15000 lb Axles	C1TT-18045-D	010	G63406
64 - 69	F-500	C2TA-18045-A	010	83216
64 - 77	F-500	C7PF-18077-A		010	83225
		D2TF-18080-HA		010	83225
67 - 69	F-500	C8TA-18045-AA	-10	G63386
70 - 77	F-500	D2HT-18045-GA	010	83308
		D2TF-18045-GA	010	83308
64 - 79	F-600 (2 x 4), F-650, F-700, F-750	C7PF-18077-A		010	83225
		D2TF-18080-HA		010	83225
		D7HT-18080-BA		010	83225
71 - 79	F-600 (4 x 4)	D2HT-18045-GA	010	83308
		D2TF-18045-GA	010	83308
80 - 94	F-600, F-6000, F-700, F-7000, F-800, F-8000, FT-700, FT-800, FT-8000 - Exc. 9000 lb Axle with H.D. Suspension & 12000 lb Axle	E0HT-18045-AA	010	83309	89446
		E0HT-18045-AB	010	83309	89446
83 - 89	F-600, F-6000, F-700, F-7000, F-800, F-8000, FT-700, FT-800, FT-8000 with 9000 lb Axle with H.D. Suspension & 12000 lb Axle	D2HF-18045-AA	010	83314
		D7HT-18045-CA	010	83314
67 - 69	F-600, F-650, F-700, F-750 with 5500, 6000, 7000 & 9000 lb Axles	C8TA-18045-AA	-10	G63386
70 - 79	F-600, F-650, F-700, F-750 with 5500, 6000, 7000 & 9000 lb Axles	D2HT-18045-GA	010	83308
		D2TF-18045-GA	010	83308
64 - 67	F-600, F-700, F-750	C7PF-18077-A		010	83225
64 - 69	F-600, F-700, F-750 with 6000 & 7000 Axle	C2TA-18045-A	010	83216
86 - 90	F-600, F-700, F-800	ASH-24446		010	83215
		AX-310		010	83215
		E6HT-18080-AA		010	83215
		E6HZ-18125-D		010	83215
80 - 90	F-600, F-700, F-800 with 13000 & 15000 lb Rear Axle	D7HT-18080-BA		010	83225
80 - 90	F-600, F-700, F-800 with 17000 & 18000 lb Rear Axle	D7HF-18080-AA		010	83215
		D7HT-18080-DA		010	83215
90	F-600, F-700, F-800, FT-800, FT-900, with Multileaf Spring	F1HT-18045-AA	010	83309	89446
89 - 94	F-600, F-700, LPO (Low Profile Vehicle)	E9HS-18045-AA	010	83309	89446
		E9HS-18080-AA		010	85716
70 - 72	F-700 (Diesel), F-750 with 9000 lb Axle	D2HF-18045-CA	010	83308
73 - 79	F-700 (Diesel), F-750 with 9000 lb Axle	D2EF-18045-AA	010	83312	89409
		D2TF-18045-AA	010	83312	89409
		D7HT-18045-BA	010	83312	89409
90 - 97	F-700, F-800	ASH-24446		010	83215
		AX-310		010	83215
		E6HT-18080-AA		010	83215
		E6HZ-18125-D		010	83215
94 - 98	F-700, F-800 with 15000, 17500, 19000 lb Taperleaf Springs	F4HT-18080-AA		010	85314
		F4HT-18080-AB		010	85314
		F5HZ-18125-A		010	85314
94 - 97	F-700, F-800 with 21000 lb Taperleaf Springs	F4HT-18080-BA		010	85001
94 - 97	F-700, F-800 with 52" or 54" Taperleaf Springs and with 10000 or 12000 lb Axle	F4HT-18045-DA	010	85063
		F5HZ-18124-C	010	85063
94 - 97	F-700, F-800 with Multileaf Spring and 14600 lb Axle	F4HT-18045-EA	010	83125
		F5HZ-18124-D	010	83125

APPLICATION GUIDE - TRUCKS, TRAILERS, AND BUSES

Year Año Année	Model Modelo Modèle	OEM #	Front		Rear	
						
						
			Fleetline	GasSLX	Fleetline	GasSLX

FORD(Cont'd.)

F Series - Conventional Cab(Cont'd.)

94 - 97	F-700, F-800 with Multileaf Spring and with 10000, 12000 or 13200 lb Axle	F4HT-18045-CB	010	83107
		F5HZ-18124-B	010	83107
94 - 98	F-700, F-800 with Taperleaf Springs and with 6000, 7000, 8500, 9000 lb Axle	F4HT-18045-AB	010	83314
		F4HT-18045-AC	010	83314
		F5HZ-18124-A	010	83314
76 - 79	F-800	D2HT-18080-HA		010	83225	...
		D2TF-18045-GA	010	83308
		D7HT-18045-GA	010	83308
		D7HT-18080-BA		010	83225	...
76 - 79	F-800 with 9000 lb Axle	D2EF-18045-AA	010	83312	89409	
		D2TF-18045-AA	010	83312	89409	
		D7HT-18045-BA	010	83312	89409	
64 - 66	F-800, F-850-,F-900, F-950, F-1000 - Exc. Diesel with 11000 CP Axle	C1TT-18045-D	010	G63406
64 - 69	F-800, F-850-,F-900, F-950, F-1000 with 6000, 7000, 9000, 11000, 12000, 15000, 18000 lb Axles (Exc. Diesel with 6000 and 7000 lb Axles)	C1TT-18045-C	010	83312	89409	
		C6PF-18077-DL	010	83312	89409	
64 - 69	F-950, F-1000, F-1100 Diesel with 7000 lb Axle	C6PF-18077-DN	010	83314

F Series - F450, F550, F650, F750 Models

99 - 04	F-450, F-550 Superduty with single or dual rear wheels with 165" or 201" wheel base	ASH-23486		010	G63461	...
		ASH-247		010	G63461	...
		AT-610		010	G63461	...
		AT-611		010	G63461	...
		F81A-18080-DCA		010	G63461	...
		F81Z-18125-DC		010	G63461	...
15 - 16	F-650 (22,000 lb GVW)	471700011530	010	85181
		ASH-24659	010	85181
		FC44-18045-BB	010	85181
		FC4Z-18124-B	010	85181
00 - 15	F-650 with 10,000 lb Front Suspension	3584116C1	010	83175
		3584116C2	010	83175
		4C4Z-18124-QA	010	83175
		AA-616	010	83175
00 - 15	F-650 with 12,000 & 13,200 lb Front Springs	3584118C2	010	85928
		4C4Z-18124-RA	010	85928
		AA-617	010	85928
15 - 16	F-650 with 13,500, 15,500 & 19,000 lb Multi-leaf Rear Springs	471700011531		010	85180	...
		ASH-24660		010	85180	...
		FC44-18080-AB		010	85180	...
		FC4Z-18125-A		010	85180	...
- 15	F-650 with 21,000 lb Rear Air Suspension	3578858C1		010	85926	...
		3578858C2		010	85926	...
		4C4Z-18125-DA		010	85926	...
05 - 10	F-650 with 22,000 lb Multi-leaf Rear Springs	4C4Z-18125-B		-10	83317	...
		501906C92		-10	83317	...
98 - 03	F-650 with 23,000 lb Multi-leaf Rear Springs	AT-696		010	83140	...
		F81A-18080-ZC		010	83140	...
		F81Z-18125-ZA		010	83140	...
00 - 15	F-650 with 6,000 to 8,000 lb Front Suspension	3584117C2	010	83135

APPLICATION GUIDE - TRUCKS, TRAILERS, AND BUSES





Year Año Année	Model Modelo Modèle	OEM #	Front		Rear	
			Fleetline	GasSLX	Fleetline	GasSLX

FORD(Cont'd.)

F Series - F450, F550, F650, F750 Models(Cont'd.)

00 - 15	F-650 with 6,000 to 8,000 lb Front Suspension	4C4Z-18124-HB	010	83135
		4C4Z-18124-P	010	83135
		AA-615	010	83135
		AT-811	010	83135
		FC4Z-18124-HB	010	83135
98 - 03	F-650 with 8500 or 9000 lb Front Axle	AA-494	010	83131
		ASH-397	010	83131
		XC35-18045-AB	010	83131
		XC35-18045-AD	010	83131
		XC35-18045-JA	010	83131
		XC3Z-18124-JA	010	83131
98 - 03	F-650 with Hendrickson HAS - 190 Rear Air Suspension	1C44-18080-AA		010	83123 89405
		60670-008		010	83123 89405
05 - 07	F-650 with O.E.M. Number	3553628C1	010	85927
		3553628C2	010	85927
15 - 16	F-750 (22,000 lb GVW)	471700011530	010	85181
		ASH-24659	010	85181
		FC44-18045-BB	010	85181
		FC4Z-18124-B	010	85181
00 - 15	F-750 with 10,000 lb Front Suspension	3584116C1	010	83175
		3584116C2	010	83175
		4C4Z-18124-QA	010	83175
		AA-616	010	83175
00 - 15	F-750 with 12,000 & 13,200 lb Front Springs	3584118C2	010	85928
		4C4Z-18124-RA	010	85928
		AA-617	010	85928
15 - 16	F-750 with 13,500, 15,500 & 19,000 lb Multi-leaf Rear Springs	471700011531		010	85180 ...
		ASH-24660		010	85180 ...
		FC44-18080-AB		010	85180 ...
		FC4Z-18125-A		010	85180 ...
- 15	F-750 with 21,000 lb Rear Air Suspension	3578858C1		010	85926 ...
		3578858C2		010	85926 ...
		4C4Z-18125-DA		010	85926 ...
05 - 10	F-750 with 22,000 lb Rear Spring Suspension	4C4Z-18125-B		-10	83317 ...
		501906C92		-10	83317 ...
98 - 03	F-750 with 23000 lb Multi-leaf Rear Springs	AT-696		010	83140 ...
		F81A-18080-ZC		010	83140 ...
		F81Z-18125-ZA		010	83140 ...
00 - 15	F-750 with 6,000 to 8,000 lb Front Suspension	3584117C2	010	83135
		4C4Z-18124-HB	010	83135
		4C4Z-18124-P	010	83135
		AA-615	010	83135
		AT-811	010	83135
		FC4Z-18124-HB	010	83135
98 - 03	F-750 with 8500 or 9000 lb Front Axle	AA-494	010	83131
		ASH-397	010	83131
		XC35-18045-AB	010	83131
		XC35-18045-AD	010	83131
		XC35-18045-JA	010	83131
		XC3Z-18124-JA	010	83131
98 - 03	F-750 with Hendrickson HAS - 190 Rear Air Suspension	1C44-18080-AA		010	83123 89405

APPLICATION GUIDE - TRUCKS, TRAILERS, AND BUSES

Year Año Année	Model Modelo Modèle	OEM #	Front				Rear			
										
				Fleetline	GasSLX		Fleetline	GasSLX		

FORD(Cont'd.)

F Series - F450, F550, F650, F750 Models(Cont'd.)

98 - 03	F-750 with Hendrickson HAS - 190 Rear Air Suspension	60670-008		010	83123	89405
05 - 07	F-750 with O.E.M. Number	3553628C1	010	85927
		3553628C2	010	85927

FT Series - Conventional Cab

90 - 92	FT-900 (Low Profile Vehicle)	E9HS-18080-AA		010	85716	...
90 - 94	FT-900 (Low Profile Vehicle)	E9HS-18045-AA	010	83309	89446	
		E9HZ-18124-A	010	83309	89446	
94 - 97	FT-900 with 46" Taperleaf Spring and 15000, 17500 or 19000 lb Axle	F4HT-18080-AA		010	85314	89425
		F4HT-18080-AB		010	85314	89425
		F5HZ-18125-DA		010	85314	89425
94 - 97	FT-900 with 46" Taperleaf Springs and 21000 lb Axle	F4HT-18080-BA		010	85001	89410
94 - 97	FT-900 with 52 or 54" Taperleaf Springs and with 10000 or 12000 lb Axle	F4HT-18045-DA	010	85063
		F5HZ-18124-C	010	85063
90 - 94	FT-900 with 9000 lb Axle with H.D. Suspension or 10000, 11000, or 12000 lb Axles	C4HZ-18124-E	010	83309	89446	
		E9HS-18045-AA	010	83309	89446	
		F1HT-18045-AA	010	83309	89446	
		F1HZ-18124-A	010	83309	89446	
94 - 97	FT-900 with Multileaf Spring and 14600 lb Axle	F4HT-18045-EA	010	83125
		F5HZ-18124-D	010	83125
94 - 97	FT-900 with Multileaf Spring and with 10000, 12000 or 13200 lb Axle	F4HT-18045-CB	010	83107
		F5HZ-18124-B	010	83107
90 - 97	FT-900 with shock located forward of rear axle	ASH-24446		010	83215	...
		AX-310		010	83215	...
		E6HT-18080-AA		010	83215	...
		E6HZ-18125-D		010	83215	...
94 - 97	FT-900, with Taperleaf Springs and with 6000, 7000, 8500 or 9000 lb Axles	F4HT-18045-AB	010	83314
		F5HZ-18124-A	010	83314











H and HT Series - Hi Tilt Cab

61 - 63	HT-950 with 11000 lb Axle	010	83314
61 - 66	HT-950 with 12000 & 15000 lb Axle	010	83314

L, LT & LTS - Conventional Cab

73 - 90	L-800, L8000, L-900, L-9000, LT-800, LT-880, LT8000, LT-900, LT-9000 with 7000, 9000, 12000 lb Axles	D2EF-18045-AA	010	83312	89409	
		D2KF-18045-AA	010	83312	89409	
		D7HF-18045-FA	010	83312	89409	
		D7HT-18045-BA	010	83312	89409	
73 - 85	L-800, L8000, L-900, L-9000, LT-800, LT-880, LT8000, LT-900, LT-9000, LTS-8000, LTS-900, LTS-9000 with 7000, 9000, 12000, 16000 lb Axles	D2HF-18045-AA	010	83314
		D2HT-18045-CA	010	83314
73 - 90	L-800, L850, L-900, L-9000, LT-800, LT-850, LT880, LT-900, LT-9000, LTS-800, LTS-850, LTS-900 with 7000, 9000, 12000, 16000 lb Axles	D2HF-18045-BA	010	83309	89446	
		D7HT-18045-DA	010	83309	89446	
94 - 97	L-8000, L-9000, LT-8000 or LT-9000 Models with 21000 or 23000 lb. with 46" Taperleaf Spring	F4HT-18080-BA		010	85001	89410
90 - 97	L-8000, L-9000, LT-8000, LT-9000 with 52" Taperleaf Spring	F1HT-18045-GA	010	85006	89401	
91 - 92	L-8000, L-9000, LT-8000, LT-9000 with 52" Taperleaf Spring	F1HT-18045-GB	010	...	89403	
90 - 97	L-8000, L-9000, LT-8000, LT-9000 with 58" Parabolic Taperleaf Spring	F1HT-18045-RA	010	...	89441	

APPLICATION GUIDE - TRUCKS, TRAILERS, AND BUSES

Year Año Année	Model Modelo Modèle	OEM #	Front				Rear			
										
										
Fleetline		GasSLX		Fleetline		GasSLX				

FORD(Cont'd.)

L, LT & LTS - Conventional Cab(Cont'd.)

90 - 97	L-8000, L-9000, LT-8000, LT-9000 with 58" Parabolic Taperleaf Spring	F1HT-18045-RB	OIO	...	89402	
	L-8000, L-9000, LT-8000, LT-9000 with Hendrickson Rear Air Suspension	47902-13		OIO	83122	89406
91 - 97	L-8000, L-9000, LT-8000, LT-9000 with Multileaf Spring	F1HT-18045-DA	OIO	83312	89409	
91 - 97	L-8000, L-9000, LT-8000, LT-9000 with 4000, 4500, 5400, 6000, 7200 lb Multileaf Springs and with 9000, 10000, 12000 or 16000 lb Axles	F1HT-18045-CB	OIO	83216
91 - 97	L-8000, L-9000, LT-8000, LT-9000 with 4500, 5400, 6000, 7200, 10000 lb Multileaf Springs and with 10000, 12000, 13200, 16000 lb Axles	F1HT-18045-DB	OIO	83308
73 - 89	LTS-800, LTS-850, LTS-900, LTS-9000 with 16000 lb Axle	D0HA-18045-E	OIO	83312	89409	
		D2HF-18045-DA	OIO	83312	89409	
		D7HT-18045-EA	OIO	83312	89409	

LA, LS & LST - Conventional Cab

96	LA-8000 Models with 12000 or 13000 lb Axles	F6HT-18045-LA	OIO	85376
96	LA-8000 Models with 16000 lb. Multileaf Spring	F6HT-18045-AA	OIO	85054	89438	
91 - 96	LA-8000, LA-9000 Models with 4000, 4500, 5400, 6000, or 7200 lb. Multileaf Spring	F1HT-18045-CB	OIO	83216
91 - 96	LA-8000, LA-9000 Models with Hendrickson Rear Air Suspension	47902-28		OIO	85013	89414
90 - 97	LA-8000, LA-9000, LS-8000, LST-8000 with 4500 lb to 10000 lb Multileaf Spring	F1HT-18045-CA	OIO	83308
90 - 97	LA-8000, LS-8000, LST-8000 with 52" Taperleaf Spring	F1HT-18045-EA	OIO	...	89402	
91 - 96	LA-8000, LS-8000, LST-8000 with 58" Taperleaf Spring	F1HT-18045-EB	OIO	...	89402	





LL, LLA, LTA, LTL, LTLA - Conventional Cab

91 - 95	LL-9000 with 4500, 5000, 6000 lb Springs and with 10000, 11000, 12000 lb Axles	F1HT-18045-DB	OIO	83308
91 - 96	LL-9000, LLA-9000, LTA-9000, LTLA-9000, with 4000, 4500, 5400, 6000 or 7200 lb Multileaf Springs and with 9000, 10000, 12000 or 16000 lb Axles	F1HT-18045-CB	OIO	83216
91 - 96	LLA-9000, LTLA-9000 with 4500, 5400, 6500 lb 58" Parabolic Taperleaf Spring	FOHT-18045-CA	OIO	85006	89401	
		F1HT-18045-HB	OIO	85006	89401	
91 - 96	LTA-9000, LLA-9000 or LTLA-9000 Models With 4500, 5400, 6000, 7200 or 10000 lb. Multileaf Spring With Hendrickson Rear Air Suspension	F1HT-18045-CA	OIO	83308
		47902-28		OIO	85013	89414
80 - 85	LTL-900, LTL-9000 with 7000, 9000, 12000 lb Axle	D2HF-18045-AA	OIO	83314

LN & LNT - Conventional Cab

72	LN-500, LN-550 with 11000, 13000, 15000, 17000 lb Axles	D2TF-18080-HA		OIO	83225	...
70 - 72	LN-500, LN-550 with 5000, 5500, 6000 & 7000 lb Axles	D2TF-18045-GA	OIO	83308
72 - 79	LN-600, LN-650, LN-700, LN-750 with 11000, 13000, 15000, 17000 lb Axles	D2TF-18080-HA		OIO	83225	...
70 - 79	LN-600, LN-650, LN-700, LN-750 with 5000, 5500, 6000 & 7000 lb Axles	D7HT-18045-GA	OIO	83308
76 - 79	LN-600, LN-650, LN-700, LN-800	D2EF-18045-AA	OIO	83312	89409	
		D7HT-18045-BA	OIO	83312	89409	
80 - 89	LN-600, LN-700, LN-7000, LN-800, LN-8000, LNT-800, LNT-8000 with 3000, 3300 lb Springs and 5000, 5500, 6000, 7000 lb Axles	D7HT-18045-GA	OIO	83308
80 - 89	LN-600, LN-700, LN-7000, LN-800, LN-8000, LNT-800, LNT-8000 with 4400 lb Spring and 7000, 9000 lb Axles	D2EF-18045-AA	OIO	83312	89409	
80 - 89	LN-600, LN-700, LN-750 with 11000, 13000, 15000, 17000 lb Axles	D7HT-18080-BA		OIO	83225	...
		C1TT-18045-C	OIO	83312	89409	
70 - 75	LN-700, LN-750 Diesel with 9000 lb Axle	D2EF-18045-AA	OIO	83312	89409	
		F4HT-18080-BA		OIO	85001	89410
94 - 97	LN-7000, LN-8000, LN-9000, LNT-8000 or LNT-9000 Models with 21000 or 23000 lb. with 46" Taperleaf Spring	F4HT-18080-BA		OIO	85001	89410

APPLICATION GUIDE - TRUCKS, TRAILERS, AND BUSES

Year Año Année	Model Modelo Modèle	OEM #	Front		Rear	
						
			Fleetline	GasSLX	Fleetline	GasSLX

FORD(Cont'd.)





LN & LNT - Conventional Cab(Cont'd.)

91 - 97	LN-7000, LN-8000, LN-9000, LNT-8000 or LNT-9000 Models with 4000, 4500, 5400, 6000 or 7200 lb. Multileaf Springs and with 9000, 10000, 12000 or 16000 lb. Axles	F1HT-18045-CB	010	83216
90	LN-7000, LN-8000, LN-9000, LNT-8000, LNT-9000 with 52" Taperleaf Spring	F1HT-18045-GA	010	85006	89401
91 - 97	LN-7000, LN-8000, LN-9000, LNT-8000, LNT-9000 with 52" Taperleaf Spring	F1HT-18045-GB	010	...	89403
90 - 97	LN-7000, LN-8000, LN-9000, LNT-8000, LNT-9000 with 58" Parabolic Taperleaf Spring	F1HT-18045-RA	010	...	89402
		F1HT-18045-RB	010	...	89402
	LN-7000, LN-8000, LN-9000, LNT-8000, LNT-9000 with Hendrickson Rear Air Suspension	47902-13		010	83122 89406
		F0HT-18080-AA		010	83122 89406
		F0HZ-18125-A		010	83122 89406
90 - 97	LN-7000, LN-8000, LN-9000, LNT-8000, LNT-9000 with Multileaf Spring	F1HT-18045-DA	010	83312	89409
91 - 97	LN-7000, LN-8000, LN-9000, LNT-8000, LNT-9000 with 4500, 5400, 6000, 7200, 10000 lb Springs and with 10000, 12000, 13200, 16000 lb Axles	F1HT-18045-DB	010	83308
76 - 77	LN-800, LN-8000, LN-900, LN-9000, LNT-800, LNT-8000, LNT-900, LNT-9000	D2KF-18045-AA	010	83312	89409
76 - 81	LN-800, LN-8000, LN-900, LN-9000, LNT-800, LNT-8000, LNT-900, LNT-9000	D2HF-18045-AA	010	83314
		D7HT-18045-CA	010	83314
70 - 71	LN-800, LN-850, LNT-900, with 7000, 9000, 12000 lb Axles	D2TF-18045-GA	010	83308
70 - 89	LN-800, LN-850, LN-8000, LN-900, LN-9000, LNT-800, LNT-850, LNT-880, LNT-8000, LNT-900, LNT-9000 with 6000, 7000, 9000, 12000, 16000 lb Axles	D2HF-18045-BA	010	83309	89446
		D7HT-18045-DA	010	83309	89446

Louisville Series - Conventional Cab

96 - 97	All Models with 10000 lb or 12000 lb Axle and 54" Taperleaf Spring	F6HT-18045-AC	010	85054	89438
		F6HZ-18124-A	010	85054	89438
		F6HZ-18124-G	010	85054	89438
96 - 97	All with 12000 lb, 13000 lb or 14600 lb Axle and 60" Taperleaf Spring	F6HT-18045-EB	010	85055	89439
		F6HT-18045-EC	010	85055	89439
		F6HZ-18124-D	010	85055	89439
		F6HZ-18124-E	010	85055	89439
96 -	All with 13200 lb or 14600 lb Axle and 54" Taperleaf Spring	F6HT-18045-GB	010	85030	89440
		F6HT-18045-GC	010	85030	89440
96 -	All with 54" Multi-leaf Spring and 14600 or 16000 lb Axle	F6HT-18045-CC	010	85055	89439
		F6HZ-18124-C	010	85055	89439
	All with 54" Multileaf Spring and with 12000 or 13200 lb Axle	F6HT-18045-BC	010	85047	89435
96 - 97	All with 54" Multileaf Spring and with 8500 or 9000 lb Axle	F6HT-18045-JB	010	83200	89402
		F6HT-18045-JC	010	83200	89402
		F6HZ-18124-J	010	83200	89402
96 - 97	All with 8500 lb or 9000 lb Axle with 54" Taperleaf Spring	F6HT-18045-HB	010	85054	89438
		F6HT-18045-HC	010	85054	89438
		F6HZ-18124-H	010	85054	89438
	All with Hendrickson HAS-400 Air Suspension	47902-28		010	85013 89414
		F6HZ-18080-FC		010	85013 89414
		F6HZ-18125-D		010	85013 89414
	All with Neway AD-123 Air Suspension	90045068		-10	89441
		F6HZ-18125-C		-10	89441

APPLICATION GUIDE - TRUCKS, TRAILERS, AND BUSES

Year Año Année	Model Modelo Modèle	OEM #	Front		Rear	
						
			Fleetline	GasSLX	Fleetline	GasSLX

FORD(Cont'd.)

Louisville Series - Conventional Cab(Cont'd.)

	All with Neway AD-246 Air Suspension	90045099	010	85906	89407
		90045132	010	85909	...

Motorhome Chassis

99 - 17	F53 Motorhome Chassis with 16,000 lb GVW to 22,000 lb GVW	1C34-18045-AA	010	83209	
		1C34-18045-JA	010	83209	
		9U94-18045-AA	010	83209	
		9U9Z-18124-A	010	83209	
		ASH-1022	010	83209	
		ASH-1205	010	83209	
		ASH-1228	010	83209	
		ASH-294	010	83209	
		AT-620	010	83209	
		AT-766	010	83209	
99 - 17	F53 Motorhome Chassis with 20,500 lb GVW to 22,000 lb GVW	9U94-18080-AA	010	83122	...	
		9U9Z-18125-A	010	83122	...	
		ASH-1023	010	83122	...	
		ASH-1206	010	83122	...	
		ASH-1230	010	83122	...	
		ASH-137	010	83122	...	
		AT-621	010	83122	...	
73 - 76	M-400 & M-500 Motorhome Chassis	010	85012	89413	010	83225	...
57 - 76	P-400 & 4000 Motorhome Chassis with H.D. Springs	010	85012	89413	

N and NT 89" BBC Conventional Cab

64 - 69	N-1100 with 11000 thru 15000 lb Axles	C6PF-18077-DN	010	83314
64 - 69	N-500, N-550, N-600, N-650, N-700 with 5000, 6000, 7000 & 9000 lb Axles	D2TF-18045-GA	010	83308
64 - 69	N-500, N-550, N-600, N-650, N-700, N-750	C7PF-18077-A	010	83225	...
		D2TF-18080-HA	010	83225	...
64 - 67	N-600, N-650, N-700, N-750 with 6000 & 7000 lb Axle	C6PF-18077-DL	010	83312	89409
67 - 69	N-750 with 9000 lb Axle	C1TT-18045-C	010	83312	89409
64 - 69	N-800, N-850, N-900, N-950 with 6000, 7000, 9000, 11000, 12000 lb Axles	C1TT-18045-C	010	83312	89409
		C6PF-18077-DL	010	83312	89409
67 - 69	N-850, N-900, N-950, N-1000, NT-850, NT-900, NT-950, NT-1000 with 6000, 7000, 9000, 11000, 12000, 15000, 18000 lb Axles	C1TT-18045-D	010	G63406

P-Series - Parcel Delivery

57 - 76	P-400 & 4000 w/ H. D. Springs	010	85012	89413	
57 - 76	P500, P-5000	010	85012	89413	010	83225	...
78 - 79	P-600	D7HT-18045-HA	010	85012	89413	
		D7HT-18080-CA	010	83225	...	









T-Series - Conventional Tandem

64 - 69	T-750, T-800, T-850, T-900, T-950 with 6000, 7000, 9000, 11000, 12000, 15000, 18000 lb Axles	C1TT-18045-D	010	G63406
64 - 69	T-750, T-800, T-850, T-900, T-950 with 9000 thru 15000 lb Axles	C1TT-18045-E	010	83314
		C6PF-18077-DN	010	83314

W and WT Series - Hi Tilt Cab Highway Tractor

66 - 71	W-900, W-950, W-1000, WT-900, WT-950, WT-1000 with 11000 lb Axle	D2HA-18045-E1A	010	85304
		D2HA-18045-E1B	010	85304
		D2HA-18045-E2A	010	85304
		D2HA-18045-E2B	010	85304

APPLICATION GUIDE - TRUCKS, TRAILERS, AND BUSES

Year Año Année	Model Modelo Modèle	OEM #	Front		Rear	
						
						
			Fleetline	GasSLX	Fleetline	GasSLX

FORD(Cont'd.)





W and WT Series - Hi Tilt Cab Highway Tractor(Cont'd.)

66 - 77	W-900, W-950,W-1000, WT-900, WT-950, WT-1000 with 12000 & 15000 lb Axle	C6TA-18045-Y	OIO	85301
			OIO	85301	
			OIO	85301	
73 - 77	W-900, WT-900 with Air Suspension	D2HZ-18080-A		OIO	83209	89414
				OIO	83209	89414
				OIO	83209	89414

Additional O.E.M. Interchanges

	HN-80 with 21000 lb or 23000 lb Axle & 52" Taper leaf Rear Suspension	F6HT-18080-JA		OIO	85305	...
	Models with O.E.M. Number	0017LA-18080-G		-IO	83161	...
		2C4Z-18124-BA	OIO	83175
		2C7Z-18125-AA		OIO	G63837	...
		2C7Z-18125-CA		OIO	G63607	...
		3U2Z-18124-BAA	OIO	G63809
		3U2Z-18124-BV	-IO	G63614
		3U2Z-18124-BW	-IO	G63614
		3U2Z-18124-EA	-IO	G63772
		3U2Z-18124-FA	-IO	G63608
		3U2Z-18124-FAA	-IO	G63809
		3U2Z-18124-JAA	-IO	G63614
		3U2Z-18124-YAA	OIO	G63809
		3U2Z-18125-AD		-IO	69575	...
		3U2Z-18125-CA		OIO	G63607	...
		3U2Z-18125-DA		OIO	G63525	...
		3U2Z-18125-EA		OIO	G63524	...
		3U2Z-18125-RA		-IO	G63623	...
		47902-8		OIO	83122	89406
		4U2Z-18V124-AA	-IO	G63678
		57365-111	OIO	85006	89401	
		5C3Z-18124-JA	-IO	G63969
		5C3Z-18125-CF		OIO	77969	...
		5C3Z-18125-DA		OIO	77968	...
		5U2Z-18V124-AA	-IO	G63714
		5U2Z-18V124-AHA	OIO	G63622
		5U2Z-18V124-AU	-IO	G63772
		5U2Z-18V124-BA	-IO	G63716
		5U2Z-18V124-CAA	OIO	G63809
		5U2Z-18V124-DB	OIO	G63455
		5U2Z-18V124-GA	-IO	G63809
		5U2Z-18V124-LA	-IO	G63929
		5U2Z-18V125-AE		OIO	G63808	...
		5U2Z-18V125-AF		OIO	G63810	...
		5U2Z-18V125-BDA		-IO	G63623	...
		5U2Z-18V125-BGA		-IO	G63778	...
		5U2Z-18V125-BS		OIO	G63607	...
		5U2Z-18V125-BT		OIO	G63525	...
		5U2Z-18V125-BU		OIO	G63524	...
		5U2Z-18V125-F		OIO	G63676	...
		5U2Z-18V125-G		OIO	G63837	...
	5U2Z-18V125-H		OIO	G63406	...	
	6C2Z-18124-B	-IO	G63929	
	6ETZ-18124-AA	OIO	83145	

APPLICATION GUIDE - TRUCKS, TRAILERS, AND BUSES



Year Año Année	Model Modelo Modèle	OEM #	Front		Rear	
						
			Fleetline	GasSLX	Fleetline	GasSLX

FORD(Cont'd.)

Additional O.E.M. Interchanges(Cont'd.)

Models with O.E.M. Number	OEM #	Fleetline	GasSLX	OEM #	Fleetline	GasSLX
6ETZ-18125-A		010	83146	...
6U2Z18V125A		010	G63837	...
6U2Z-18V125-B		010	G63607	...
70127	010	85006	89401	
70128	010	85006	89401	
7C34-18045-HB	-10	G63969
7C34-18080-DCB		010	77968	...
7W7Z-18125-B		-10	69574	...
90044769		010	83207	89407
90044770		010	83207	89407
AX-267A	010	83309	89446	
B3Q-18124-A	010	83219
B3Q-18125-A		010	83217	...
B3TZ-18125-A		010	83217	...
B6TZ-18124-A	010	83219
B6TZ-18125-B		-10	83161	...
B6TZ-18125-C		-10	83161	...
B6TZ-18125-E		-10	83161	...
B7C-18125-A		010	83217	...
B7T-18124-C	010	83225
B7TZ-18124-B	010	83216
B7TZ-18124-C	010	83216
B7TZ-18124-D	010	83219
B7TZ-18124-E	010	83217
B7TZ-18125-C		010	83217	...
B8Q-18125-A		010	85307	...
B8QZ-18124-A	010	83312	89409	
B8TZ-18124-A	010	83219
B9TT-18045-C	010	83219
B9TT-18045-D	010	83219
B9TT-18080-B		-10	83161	...
B9TZ-18125-B		-10	83161	...
C0TT-18045-A	010	83219
C0TT-18045-D	010	83216
C0TZ-18124-A	010	83216
C1TT-18045-G	010	83216
C1TT-18080-B		010	83217	...
C1TZ-18045-C	010	83312	89409	
C1TZ-18124-A	010	83217
C1TZ-18124-B	010	83216
C1TZ-18124-C	010	83312	89409	
C1TZ-18124-D	010	83309	89446	
C1TZ-18124-E	010	83312	89409	
C1TZ-18124-F	010	83312	89409	
C1TZ-18124-N	010	83314
C1TZ-18124-P	010	83312	89409	
C1TZ-18125-B		010	83217	...
C1VT-18080-B		010	83217	...
C2TA-18045-B	010	83308
C2TZ-18124-A	010	83308
C3TA-18045-A	010	83216

APPLICATION GUIDE - TRUCKS, TRAILERS, AND BUSES





Year Año Année	Model Modelo Modèle	OEM #	Front		Rear	
						
			Fleetline	GasSLX	Fleetline	GasSLX

FORD(Cont'd.)

Additional O.E.M. Interchanges(Cont'd.)

Models with O.E.M. Number								
C3TZ-18124-A	010	83308		
C4HZ-18124-A	010	83312	89409			
C4HZ-18124-B	010	83309	89446			
C4HZ-18124-C	010	83314		
C4HZ-18124-D	010	83312	89409			
C4HZ-18124-F	010	83308		
C4PF-18045-H	010	83216		
C4TZ-18124-AA	010	83308		
C4TZ-18124-AB	010	83308		
C4TZ-18124-B	010	83308		
C5TZ-18124-A	010	83308		
C6PF-18077-AC		-10	83161	...		
C6TA-18045-U	010	85301		
C6TA-18045-V	010	85301		
C6TS-18080-A		010	83217	...		
C6TZ-18124-D	010	85301		
C6TZ-18124-E	010	85301		
C6TZ-18124-H	010	85301		
C6TZ-18124-J	010	85301		
C7HZ-18124-A	010	83312	89409			
C7TA-18045-R	010	83216		
C7TA-18045-Z	010	85301		
C8PF-18045-CM	010	83216		
C8PF-18045-S	-10	83161		
C8PF-18045-T	-10	83161		
C8TA-18080-Y		-10	83161	...		
C8TA-18080-Z		-10	83161	...		
C8TZ-18125-D		-10	83161	...		
D0HA-18045-D	010	83309	89446			
D0HZ-18124-A	010	83309	89446			
D0HZ-18124-B	010	83312	89409			
D0HZ-18124-C	010	83314		
D1TZ-18124-D	010	83308		
D1TZ-18124-E	010	83216		
D1TZ-18124-F	010	83312	89409			
D1TZ-18125-E		010	83217	...		
D2EF-18124-AA	010	83312	89409			
D2HA-18045-EB	010	85301		
D2HA-18045-F1A	010	85301		
D2HA-18045-F1B	010	85301		
D2HA-18045-F2A	010	85301		
D2HA-18045-F2B	010	85301		
D2HF-18045-A	010	83314		
D2HF-18124-AA	010	83314		
D2HT-18045-EA	010	83312	89409			
D2HZ-18125-A		010	83209	89414		
D2HZ-18125-B		010	83209	89414		
D2KF-18124-AA	010	83312	89409			
D2TA-18045-AAA	010	83219		
D2TA-18045-ZA	010	83219		
D2TF-18045-FA	010	83312	89409			

APPLICATION GUIDE - TRUCKS, TRAILERS, AND BUSES





Year Año Année	Model Modelo Modèle	OEM #	Front		Rear	
						
			Fleetline	GasSLX	Fleetline	GasSLX

FORD(Cont'd.)

Additional O.E.M. Interchanges(Cont'd.)

Models with O.E.M. Number					
D2TF-18080-NA			010 83217 ...
D2TF-18124-F	010	83309	89446	
D2TZ-18124-A	010	83308
D2TZ-18124-E	010	83312	89409	
D2TZ-18124-F	010	83309	89446	
D2TZ-18124-G	010	83314
D2TZ-18124-H	010	83308
D2TZ-18124-J	010	83312	89409	
D3TA-18045-BA	010	83219
D3TZ-18124-B	010	83219
D3TZ-18125-C		010	83217 ...
D3TZ-18125-D		010	83217 ...
D4HA-18080-A		010	83209 89414
D4TF-18045-AA	010	83312	89409	
D4TZ-18124-J	010	83308
D5TZ-18124-B	010	83308
D5TZ-18124-C	010	83312	89409	
D7HF-18125-AA		010	83215 ...
D7HT-18124-BA	010	83312	89409	
D7HT-18124-CA	010	83314
D7HT-18124-DA	010	83309	89446	
D7HT-18124-EA	010	83312	89409	
D7HT-18124-FA	010	83312	89409	
D7HT-18124-GA	010	83308
D7HT-18124-HA	010	83219
D7HT-18124-JA	010	83308
D7HT-18124-KA	010	85301
D7HT-18125-BA		010	83217 ...
D7HT-18125-CA		010	83217 ...
D7HT-18125-DA		010	83215 ...
D7HT-18125-FA		010	83123 89405
D7HZ-18125-A		010	83215 ...
D7TA-18124-GA	010	83314
D7TZ-18125-C		010	83217 ...
D8HZ-18124-A	010	85301
D8HZ-18125-A		010	83209 89414
D8HZ-18125-B		010	83123 89405
E0HZ-18124-A	010	83309	89446	
E1TA-18045-AA	010	83309	89446	
E1TD-18045-AA	010	83309	89446	
E5HT-18045-DA	010	85301
E5HT-18045-EA	010	85301
E6HZ-18124-D	010	85301
E6HZ-18125-E		010	85315 ...
E6HZ-18125-F		010	85315 ...
E7XZ-18124-A	-10	G63386
E7XZ-18124-B	-10	G63500
E7XZ-18124-C	-10	G63511
E7XZ-18124-D	-10	G63396
E7XZ-18124-F	-1-	G63398
E7XZ-18124-G	-1-	G63398

APPLICATION GUIDE - TRUCKS, TRAILERS, AND BUSES









Year Año Année	Model Modelo Modèle	OEM #	Front		Rear	
						
			Fleetline	GasSLX	Fleetline	GasSLX

FORD(Cont'd.)

Additional O.E.M. Interchanges(Cont'd.)

Models with O.E.M. Number						
E7XZ-18125-A		-10	G63350	...
E7XZ-18125-B		-10	G63387	...
E7XZ-18125-C		010	G63409	...
E7XZ-18125-D		010	G63406	...
E7XZ-18125-E		010	G63406	...
E7XZ-18125-G		010	G63811	...
E7XZ-18125-J		010	G63299	...
E9HZ-18125-A		010	85716	...
E9HZ-18125-AA		010	85716	...
FOHS-18045-AA	010	85006	89401	
FOHT-18045-AA	010	85006	89401	
FOHZ-18124-A	010	85006	89401	
FOHZ-18124-B	010	85006
F1HT-18045-KB	010	85006	89401	
F1HT-18045-LB	010	85006	89401	
F1HZ-18124-AA	010	83309	89446	
F1HZ-18124-B	010	83308
F1HZ-18124-C	010	...	89402	
F1HZ-18124-D	010	85006	89401	
F1HZ-18124-E	010	85006	89401	
F1HZ-18124-F	010	85006	89401	
F1HZ-18124-G	010	85006	89401	
F1HZ-18124-H	010	85040
F1HZ-18124-J	010	83308
F1HZ-18124-K	010	...	89402	
F2HT-18045-DA	010	85006	89401	
F2HT-18080-DA		010	85712	...
F2HZ-18124-B	010	85301
F2HZ-18124-C	010	85006	89401	
F2HZ-18125-A		010	85712	...
F4TA-18045-TA	010	G63455
F4TA-18080-PA		010	G63461	...
F4TZ-18124-D	-10	G63414
F4TZ-18124-K	010	G63455
F4TZ-18125-E		010	G63461	...
F4TZ-18125-L		010	G63406	...
F57Z-18125-BB		010	G63679	...
F5HZ-18124-AA	010	83314
F5HZ-18124-C	010	85063
F5HZ-18124-DA	010	83125
F5HZ-18125-A		010	85314	89425
F5HZ-18125-AA		010	85314	89425
F5HZ-18125-B		010	85001	89410
F5HZ-18125-BA		010	85001	89410
F5TZ-18124-B	-10	G63608
F5TZ-18125-BC		010	G63607	...
F5UZ-18124-A	01-	G63622
F5UZ-18124-B	01-	G63622
F5UZ-18125-A		-10	G63623	...
F5UZ-18125-C		-10	G63624	...
F6HT-18045-KA	010	83200	89402	

APPLICATION GUIDE - TRUCKS, TRAILERS, AND BUSES

Year Año Année	Model Modelo Modèle	OEM #	Front		Rear	
						
						
			Fleetline	GasSLX	Fleetline	GasSLX

FORD(Cont'd.)

Additional O.E.M. Interchanges(Cont'd.)

	Models with O.E.M. Number				
	F6HT-18045-MA	010	85006	89401	...
	F6HT-18080-CA		010 85314 89425
	F6HT-18080-EA		010 85906 89407
	F6HT-18080-FC		010 85013 89414
	F6HZ-18124-B	010	83308
	F6HZ-18124-KA	010	83200	89402	...
	F6HZ-18124-MA	010	85006	89401	...
	F6HZ-18125-A		010 85314 89425
	F6HZ-18125-JA		010 85305 ...
	F7C2Z-18124-BR	-10	G63929
	F7TA-18045-AA	-10	G63608
	F7TA-18080-BA		010 G63607 ...
	F81Z-18124-AL	01-	G63622
	F81Z-18124-BK	010	G63809
	F81Z-18124-PA	010	85928
	F87Z-18125-CA		010 G63773 ...
	F87Z-18125-RA		010 G63775 ...
	LA-18080		-10 83161 ...
	LA-18080-A		-10 83161 ...
	LA-18080-B		-10 83161 ...
	LA-18080-C		-10 83161 ...
	LA-18080-F		-10 83161 ...
	LA-18080-J		-10 83161 ...
	TAAH-18080-A		-10 83161 ...
	TAAH-18080-A2		-10 83161 ...
	TAAH-18080-A3		-10 83161 ...
	TAAK-18080-A		-10 83161 ...
	TAAK-18080-A1		-10 83161 ...
	TAAK-18080-A2		-10 83161 ...
	TACAA-18045-A	010	83216
	TANNA-18045-A	010	83312	89409	...
	TBAK-18080-A		-10 83161 ...
	TBDA-18080-A		010 83217 ...
	TBDA-18080-B		010 83217 ...
	TDAA-18080-A		-10 83161 ...
	TDAA-18080-B		010 83217 ...
	TDBA-18045-A	010	83219
	TDBA-18045-B	010	83219
	TDBA-18080-A		010 83217 ...
	TDBA-18080-B		010 83217 ...
	TDBA-18080-C		010 83217 ...
	TDBE-18045-A	010	83219
	TFAA-18045-B	010	83219
	TFAA-18045-C	010	83219
	TFAA-18080-A		010 85307 ...
	THAB-18045-A	010	83219
	THAB-18045-B	010	83219
	TQSH-18045-A	010	83309	89446	...
	XC45-18045-AA	010	83216
	XL2Z-18124-EA	-10	G63678
	XL2Z-18125-BA		010 G63679 ...

APPLICATION GUIDE - TRUCKS, TRAILERS, AND BUSES

Year Año Année	Model Modelo Modèle	OEM #	Front		Rear	
			Fleetline	GasSLX	Fleetline	GasSLX

FORD(Cont'd.)

Additional O.E.M. Interchanges(Cont'd.)

	Models with O.E.M. Number	XL2Z-18125-CA		010	G63679	...
		XL2Z-18125-EA		010	G63679	...
		YL5Z-18124-AA	-10	G63772
	Additional O.E.M. Interchanges	680029	010	85301				
		C6PF-18077-DD	010	83216				
		C6PF-18077-DE	010	83219				
		C7PF-18077-Z	010	83217				

FORD CAB SHOCKS

8500 Series

	Models with 101", 113" & 122" BBC Conventional Tractors with Link Cabmate Models FH101, FH1322 & FH1322-A	1201-1043	010			83025
		1202-1043	010	83025		

9500 Series

	Models with 101", 113" & 122" BBC Conventional Tractors with Link Cabmate Models FH101, FH1322 & FH1322-A	1201-1043	010	83025			
		1202-1043	010	83025			
	Models with O.E.M. Number	F6HZ-5K407-AB	010	83034			
		F6HZ-5K407-BA	010	83033			
		F8HT-5K407-AA	010	83033			

Additional Applications

	CL9000 & CLT9000 Cabover Tractors (Sleeper & Non-Sleeper) with Link Cabmate Model FCL110-2P	1202-0032	010	83016			
		1202-0022	010	83046			
	Models with Link Cab Suspension	1202-0042	010	83025			

L-Series Conventional





	All with 60" Able Body Sleepers with Link Bunkmate Models FAS60-A & FAS60-AS	1201-1044	010	83025			
		1202-1044	010	83025			
	L, LT, LN, LNT 800, 8000, 9000 Models, LTS, LS 8000, 9000 Models, & LTL, LL 9000 Models with Link Cabmate Model FN89-A	1201-0012	010	83023			
		1202-0012	010	83023			

FOREST RIVER INC

Class A MotorHomes

02 - 04	Reflection Series MotorHomes with Freightliner XC Chassis ADL200 Suspension w/ 20K Rear AS120 Front Suspension Rear Shock with O.E.M. Number ZF - IFS Front Suspension with 23,000 lb GVW or Greater		16-16873-000		010	85029	...
			141700131810	010	83160
			16-16737-000	010	83160
			16-16874-000	010	83160
			141700131809	010	010	85029	...
			16-16736-000	010	010	85029	...
			16-18103-000	-10	85900
			481700000493	-10	85900
02 - 06	Tsunami Series MotorHomes with Freightliner XC Chassis ADL200 Suspension w/ 20K Rear AS120 Front Suspension Rear Shock with O.E.M. Number ZF - IFS Front Suspension with 23,000 lb GVW or Greater		16-16873-000		010	85029	...
			141700131810	010	83160
			16-16737-000	010	83160
			16-16874-000	010	83160
			141700131809	010	010	85029	...
			16-16736-000	010	010	85029	...
			16-18103-000	-10	85900

APPLICATION GUIDE - TRUCKS, TRAILERS, AND BUSES

Year Año Année	Model Modelo Modèle	OEM #	Front		Rear	
						
			Fleetline	GasSLX	Fleetline	GasSLX

FOREST RIVER INC(Cont'd.)

Class A MotorHomes(Cont'd.)

02 - 06	ADL200 Suspension w/ 20K Rear	48170000493	- -	85900
---------	-------------------------------	-------------	-----	-------	-----	-----	-----	-----

FREIGHTLINER

Argosy

99 - 07	Models with 12000 lb Taperleaf Front Suspension	10-12703-000 10-13634-000 471700000449	O O	85918	89449
			O O	85918	89449
			O O	85918	89449
99 - 07	Models with Freightliner FAS II Rear Air Suspension	16-13957-000 16-15817-000 680339 680611	O O	85724	89443
			O O	85724	89443
			O O	85724	89443
			O O	85724	89443
99 - 07	Models with Freightliner Low Profile Rear Air Suspension (18,000 to 40,000 lb)	16-14259-000 16-18706-000 471700002992 680511	O O	85331	...
			O O	85331	...
			O O	85331	...
			O O	85331	...
99 - 07	Models with Rear 10000 lb - 15000 lb Low Profile AirLiner	16-16577-000 16-18711-000 471700002996	O O	85335	...
			O O	85335	...
			O O	85335	...

Cargo - FC70 & FC80

99 - 07	FC70 & FC80 Models with 10,000 to 18,000 lb Suspension	10-13759-000 471700003009 6803230300 GBL665538	O O	85006
			O O	85006
			O O	85006
			O O	85006
99 - 07	FC70 & FC80 Models with 6000 to 9000 lb Front Axle	654654 6803230200	O O	85043
			O O	85043
99 - 07	FC70 & FC80 Models with FAS II Rear Air Suspension	16-13957-000 16-15817-000 680339 680611	O O	85724	89443
			O O	85724	89443
			O O	85724	89443
			O O	85724	89443









Cascadia

09 - 17	Models with 12000 to 13300 lb Taperleaf Front Suspension	10-13809-000 SDA471400003920	O O	85958
			O O	85958
09 - 17	Models with Hendrickson Front Airtek	471700006269 471700131331 58913-003 58913-012	O O	85932	89453
			O O	85932	89453
			O O	85932	89453
			O O	85932	89453
09 - 17	Models with FAS II (40,000 lb) Rear Air Suspension	16-15817-000 16-18708-000 471700002809 680611 SDA471700002809	O O	85724	89443
			O O	85724	89443
			O O	85724	89443
			O O	85724	89443
			O O	85724	89443

Century Class - C112, C120, CST112 & CST120

00 - 11	Models with 12000 lb Taperleaf Front Suspension	10-13021-000 10-13063-000 10-13211-000 10-13634-000 471700000449 471700000449 471700131155	O O	85918	89449
			O O	85918	89449
			O O	85918	89449
			O O	85918	89449
			O O	85918	89449
			O O	85918	89449
			O O	85918	89449
97 - 99	Models with 12000 lb Taperleaf Front Suspension	10-12542-000	O O	85901

APPLICATION GUIDE - TRUCKS, TRAILERS, AND BUSES

Year Año Année	Model Modelo Modèle	OEM #	Front		Rear	
						
						
			Fleetline	GasSLX	Fleetline	GasSLX

FREIGHTLINER(Cont'd.)

Century Class - C112, C120, CST112 & CST120(Cont'd.)

97 - 11	Models with FAS II Rear Air Suspension	16-13957-000		010	85724	89443
		16-15817-000		010	85724	89443
		16-18708-000		010	85724	89443
		471700002809		010	85724	89443
		680339		010	85724	89443
		680611		010	85724	89443
		SDA471700002809		010	85724	89443
97 - 11	Models with Freightliner Low Profile Rear Air Suspension (18,000 to 40,000 lb)	16-14259-000		010	85331	...
		16-18706-000		010	85331	...
		471700002992		010	85331	...
		680511		010	85331	...
02 - 11	Models with Hendrickson Front Airtek	471700131331	010	85932	89453	
		58913-003	010	85932	89453	
	Models with Low Profile Front	10-12703-000	010	85918	89449	









Classic/ClassicXL

03 - 11	Models with 12000 lb Taperleaf Front Suspension	10-13021-000	010	85918	89449	
		10-13063-000	010	85918	89449	
		10-13211-000	010	85918	89449	
		10-13634-000	010	85918	89449	
		471700000449	010	85918	89449	
		471700000449	010	85918	89449	
		471700131155	010	85918	89449	
03 - 11	Models with FAS II Rear Air Suspension	16-15817-000		010	85724	89443
		16-18708-000		010	85724	89443
		471700002809		010	85724	89443
		680611		010	85724	89443
		SDA471700002809		010	85724	89443
03 - 11	Models with Hendrickson Front Airtek	471700131331	010	85932	89453	
		58913-003	010	85932	89453	
	Models with O.E.M. Number	10-12032-002	010	85320	89429	
		10-12032-004	010	85320	89429	
		680009	010	85302	89420	
		70029	010	85308	89422	

Columbia

03 - 08	Models with 12000 lb Taperleaf Front Suspension	10-13021-000	010	85918	89449	
		10-13063-000	010	85918	89449	
		10-13211-000	010	85918	89449	
		10-13634-000	010	85918	89449	
		471700000449	010	85918	89449	
		471700131155	010	85918	89449	
		09 - 17	Models with 12000 lb Taperleaf Front Suspension	10-13809-000	010	85958	...	
SDA471400003920	010			85958
03 - 17	Models with Hendrickson Front Airtek	471700006269	010	85932	89453	
		471700131331	010	85932	89453	
		58913-003	010	85932	89453	
		58913-012	010	85932	89453	
	Models with O.E.M. Number	10-13684-000	010	85918	89449	
		471700000470	010	85918	89449	
03 - 17	Models with FAS II Rear Air Suspension	16-15817-000		010	85724	89443
		16-18708-000		010	85724	89443

APPLICATION GUIDE - TRUCKS, TRAILERS, AND BUSES

Year Año Année	Model Modelo Modèle	OEM #	Front		Rear	
						
						
			Fleetline	GasSLX	Fleetline	GasSLX

FREIGHTLINER(Cont'd.)

Columbia(Cont'd.)

03 - 17	Models with FAS II Rear Air Suspension	47170002808	OIO	85724	89443
		47170002809	OIO	85724	89443
		680611	OIO	85724	89443
		SDA47170002809	OIO	85724	89443

Condor

01 - 07	Models with 14,600 to 20,000 lb Front Suspension	10-13211-000	OIO	85918	89449	
		10-13634-000	OIO	85918	89449	
		47170000449	OIO	85918	89449	
		471700131155	OIO	85918	89449	
01 - 07	Models with Chalmers 46,000 lb Rear Suspension	665174		OIO	85060	...
01 - 07	Models with FAS II Rear Air Suspension	16-13957-000		OIO	85724	89443
		16-15817-000		OIO	85724	89443
		16-18708-000		OIO	85724	89443
		47170002809		OIO	85724	89443
		680339		OIO	85724	89443
	SDA47170002809		OIO	85724	89443	
01 - 07	Models with Freightliner TufTrac Rear Air Suspension	16-15770-000		OIO	85956	...
		481700125969		OIO	85956	...

Coronado

10 - 17	Models with 12,000 lb to 20,000 Front Axle	10-13809-000	OIO	85958	
		471700003920	OIO	85958	
10 - 16	Models with Hendrickson Front Airtek	471700006269	OIO	85932	89453	
		471700131331	OIO	85932	89453	
		58913-003	OIO	85932	89453	
		58913-012	OIO	85932	89453	
10 - 14	Models with Chalmers 46,000 lb Rear Suspension	665174		OIO	85060	...
10 - 17	Models with FAS II (40,000 lb) Rear Air Suspension	16-15817-000		OIO	85724	89443
		16-18708-000		OIO	85724	89443
		47170002809		OIO	85724	89443
		680611		OIO	85724	89443
		SDA47170002809		OIO	85724	89443
10 - 17	Models with Freightliner TufTrac Rear Air Suspension	16-15770-000		OIO	85956	...
		481700125969		OIO	85956	...





FL50, 60, 70, 80 - Business Class

	FAS Airliner, Single / Tandem Past Production	16-11133-000		OIO	85007	89412
92 - 06	FL Models with 15000 lb Rear Suspension	6803260000		OIO	83120	...
		GBL654725		OIO	83120	...
92 - 06	FL Models with 10,000 to 18,000 lb Suspension	10-13759-000	OIO	85006	
		471700003009	OIO	85006	
		6803230300	OIO	85006	
		GBL665538	OIO	85006	
92 - 06	FL Models with 6000 to 9000 lb Front axle	654654	OIO	85043	
		6803230200	OIO	85043	
92 - 06	FL Models with FAS II Rear Air Suspension	16-13957-000		OIO	85724	89443
		16-15817-000		OIO	85724	89443
		680339		OIO	85724	89443
		680611		OIO	85724	89443

FLA & FLB Series - COE Truck & Tractor

89 - 02	COE Models	10-12030-002	OIO	85320	89429
		10-12032-000	OIO	85320	89429
		10-12032-001	OIO	85320	89429

APPLICATION GUIDE - TRUCKS, TRAILERS, AND BUSES

Year Año Année	Model Modelo Modèle	OEM #	Front		Rear	
						
			Fleetline	GasSLX	Fleetline	GasSLX

FREIGHTLINER(Cont'd.)









FLA & FLB Series - COE Truck & Tractor(Cont'd.)

89 - 02	COE Models	10-12032-002	010	85320	89429	
		10-12032-003	010	85320	89429	
		10-12032-004	010	85320	89429	
89 - 02	COE Models with Airliner Rolling Lobe Spring Air Suspension	16-13947-000		-10	85319	89428
		681-326-0400		-10	85319	89428
89 - 02	COE Models with Convolute Spring Air Suspension	16-12117-000		010	85007	89412
		16-18705-000		010	85007	89412
		471700002990		010	85007	89412
		665236		010	85007	89412
89 - 02	COE Models with FAS II Rear Air Suspension	16-13957-000		010	85724	89443
		16-15817-000		010	85724	89443
		680339		010	85724	89443
		680611		010	85724	89443
	COE Models with Neway Tag Axle Air Suspension	90044162		010	83128	89436

FLC & FLD Series - 112 & 120 Conventional Truck & Tractor

00 - 11	Conventional Models with 12000 lb Taperleaf Front Suspension	10-13021-000	010	85918	89449	
		10-13063-000	010	85918	89449	
		10-13211-000	010	85918	89449	
		10-13634-000	010	85918	89449	
		471700000449	010	85918	89449	
		471700000449	010	85918	89449	
		471700131155	010	85918	89449	
- 94	Conventional Models with Airliner Rolling Lobe Spring Air Suspension	16-13947-000		-10	85319	89428
		681-326-0400		-10	85319	89428
- 08	Conventional Models with Convolute Spring Air Suspension	16-12117-000		010	85007	89412
		16-18705-000		010	85007	89412
		471700002990		010	85007	89412
		665236		010	85007	89412
- 11	Conventional Models with FAS II Rear Air Suspension	16-13957-000		010	85724	89443
		16-15817-000		010	85724	89443
		16-18708-000		010	85724	89443
		471700002809		010	85724	89443
		680339		010	85724	89443
		680611		010	85724	89443
		SDA471700002809		010	85724	89443
02 - 11	Conventional Models with Hendrickson Front Airtek	471700131331	010	85932	89453	
		58913-003	010	85932	89453	
	Conventional Models with Neway Tag Axle Air Suspension	90044162		010	83128	89436
	Conventional Models with O.E.M. Number	10-12030-002	010	85320	89429	
		10-12032-000	010	85320	89429	
		10-12032-001	010	85320	89429	
		10-12032-002	010	85320	89429	
		10-12032-003	010	85320	89429	
		10-12032-004	010	85320	89429	
09 - 11	Models with 12000 lb Taperleaf Front Suspension	10-13809-000	010	85958
		SDA471400003920	010	85958
08 - 11	Models with Freightliner TufTrac Rear Air Suspension	16-15770-000		010	85956	...
		481700125969		010	85956	...
		SDA481700125969		010	85956	...

APPLICATION GUIDE - TRUCKS, TRAILERS, AND BUSES

Year Año Année	Model Modelo Modèle	OEM #	Front		Rear	
						
						
			Fleetline	GasSLX	Fleetline	GasSLX

FREIGHTLINER(Cont'd.)

Legacy(Cont'd.)

- 98	Models with FAS II Rear Air Suspension	16-13957-000 680339		OIO	85724	89443
99 -	Models with FAS II Rear Air Suspension	16-15817-000 680611		OIO	85724	89443
				OIO	85724	89443
	Models with O.E.M. Number	681-323-0900	-IO	85009



M2 - Business Class

02 - 08	Models with 10000 to12000 lb. Taper-leaf Spring Suspension	10-12390-000	OIO	85920
05 - 08	Models with 12000 lb Taperleaf Front Suspension	10-13634-000 471700000449	OIO	85918	89449	
			OIO	85918	89449	
09 - 17	Models with 13300 lb to 20000 Front Axle	10-13809-000 471700003920	OIO	85958
			OIO	85958
02 - 08	Models with 6000 to 9000 lb Front axle	10-12388-000	OIO	85920
09 - 17	Models with 8000 to 16000 lb Front Axle and Taperleaf Spring	10-13592-000 10-13760-000 471700000440 471700002391 SDA471700002991	OIO	85959
			OIO	85959
			OIO	85959
			OIO	85959
02 - 17	Models with FAS II Rear Air Suspension	16-15817-000 16-18708-000 471700002809 680611 SDA471700002809		OIO	85724	89443
				OIO	85724	89443
				OIO	85724	89443
				OIO	85724	89443
02 - 15	Models with Freightliner Low Profile Rear Air Suspension (18,000 to 40,000 lb)	16-14259-000 16-18706-000 471700002992 680511		OIO	85331	...
				OIO	85331	...
				OIO	85331	...
				OIO	85331	...
02 -	Models with Rear 10000 lb - 15000 lb Low Profile AirLiner	16-16577-000 16-18711-000 471700002996		OIO	85335	...
				OIO	85335	...
				OIO	85335	...
02 - 14	Models with Rear 52" Spring ,10000 lb - 15000 lb	16-16486-000 16-18710-000 471700002995		-IO	83134	...
				-IO	83134	...
				-IO	83134	...
02 - 14	Models with Rear 52" Spring ,18000 lb - 23000 lb	16-16442-000 16-18709-000 471700002994		-IO	83134	...
				-IO	83134	...
				-IO	83134	...
02 -	Models with Rear 60" Spring ,18000 lb - 23000 lb	16-15765-000 16-18707-000 471700002993		-IO	85921	...
				-IO	85921	...
				-IO	85921	...
- 04	Models with Taperleaf Front Suspension	10-13211-000 471700131155	OIO	85918	89449	
			OIO	85918	89449	

Severe Duty Series - 108SD, 114SD & 122SD

12 - 16	All Models with 12,000 to16,000 lb. Front Axle and Taperleaf Spring	10-13760-000 471700002991	OIO	85959
			OIO	85959
12 - 17	All Models with 18,000 lb Flat Leaf Spring	10-13684-000 471700000470	OIO	85918	89449	
			OIO	85918	89449	
12 - 17	All Models with 20,000 lb Flat Leaf Spring	10-13809-000 471700003920	OIO	85958
			OIO	85958
12 - 14	All Models with O.E.M. Number	10-13934-000 471700006929	OI-	85123
			OI-	85123
12 - 17	All Models with FAS II (40,000 lb) Rear Air Suspension	16-15817-000		OIO	85724	89443

APPLICATION GUIDE - TRUCKS, TRAILERS, AND BUSES

Year Año Année	Model Modelo Modèle	OEM #	Front		Rear	
						
			Fleetline	GasSLX	Fleetline	GasSLX

FREIGHTLINER(Cont'd.)









Severe Duty Series - 108SD, 114SD & 122SD(Cont'd.)

12 - 17	All Models with FAS II (40,000 lb) Rear Air Suspension	16-18708-000	010	85724	89443
		471700002809	010	85724	89443
		680611	010	85724	89443
		SDA471700002809	010	85724	89443
12 - 17	All Models with Freightliner TufTrac Rear Air Suspension	16-15770-000	010	85956	...
		481700125969	010	85956	...
12 - 17	All Models with Hendrickson HMX 400/460 Haulmax - with 16.5" Saddle - with 17.5" & 18.5" Saddle	60680-004	01-	83143	...
		60680-005	01-	83142	...

Additional O.E.M. Interchanges

	Models with 7000 lb Front Suspension	10-13776-000	010	85005	89430	
	Models with Neway Air Suspension with shock stamping	90045083		010	85910	...
	Models with O.E.M. Number	10-12046-000	010	85320	89429	
		10-12594-000	010	85984
		16-10688-000		010	85042	...
		16-14577-000	010	85043
		16-14669-000	010	G63403
		16-14759-000	010	85000	89436	
		16-19138-000	010	85058	89431	
		3638112		010	G63183	...
		4036892	010	G63605
		471700000440	010	85959
		471700002991	010	85959
		47902-13		010	83122	89406
		535228	010	85302	89420	
		61300224	010	85918	89449	
		61300240	010	85918	89449	
		650224		010	83225	...
		651352		010	85042	...
		654875		010	83117	...
		654918	010	83118
		659060	010	85920
		659062		-10	83134	...
		659063		-10	83134	...
		659300	010	85005	89430	
		660235		010	85042	...
		665409	-10	85009
		671908	010	85918	89449	
		671945	010	85920
		671946		-10	85921	...
		680009	010	85302	89420	
		680442		-10	85319	89428
		680651		010	85335	...
		680782	010	85302	89420	
		6813230900	-10	85009
6813260000		010	83634	...		
6813260200		010	85011	...		
70042	010	85302	89420			
GBL 651356		010	83634	...		
SDA471700000440	010	85959		
	Additional O.E.M. Interchanges	10-13051-001	010	85005 or 89430				

APPLICATION GUIDE - TRUCKS, TRAILERS, AND BUSES

Year Año Année	Model Modelo Modèle	OEM #	Front		Rear	
						
						
			Fleetline	GasSLX	Fleetline	GasSLX

FREIGHTLINER(Cont'd.)

Additional O.E.M. Interchanges(Cont'd.)

Additional O.E.M. Interchanges	OEM #	OIO	85918	89449
	10-13205-000	OIO				
	10-13859-000	OIO	85005 or 89430			
	16-14667-000	OIO	85005 or 89430			
	16-14668-000	OIO	83127			
	16-15591-000	OIO	85043			
	16-16765-000	OIO	85006			
	16-17759-000	OIO	85919			
	16-18094-000	OIO	85959			
	471700131646	OIO	85918	89449
	680008	OIO	85300 or 89419			
	680017	OIO	85302 or 89420			
	681-323-1100	OIO	85301			

FREIGHTLINER CAB SHOCKS

Argosy

00 - 06	Models with O.E.M. Number	18-37813-000	OIO	83044
---------	---------------------------	--------------	-----	--------------

Cascadia

09 - 17	Models with 72" High-Roof Sleeper	18-41762-000	OIO	83038
		18-60764-000	OIO	83038
		814903003528	OIO	83038

Century Class

	Day Cab Suspensions with O.E.M. Number	18-32999-001	OIO	83006
	Models with O.E.M. Number	18-41762-000	OIO	83038
	Sleeper-Cabs with O.E. Number	18-30378-000	OIO	83001
		18-32999-000	OIO	83001

Classic

	Models with O.E.M. Number	18-29846-000	OIO	83009
--	---------------------------	--------------	-----	--------------

Columbia

	Models with O.E.M. Number	18-29846-000	OIO	83009
03 - 17	Models with Sleeper Cabs w/O.E.M. Numbers	18-41762-000	OIO	83038
		18-60764-000	OIO	83038
		814903003528	OIO	83038

Coronado

10 - 17	Models with Sleeper Cabs w/O.E.M. Numbers	18-41762-000	OIO	83038
		18-41762-002	OIO	83038
		18-60764-000	OIO	83038
		18-60765-002	OIO	83038
		814903003528	OIO	83038

FL 60, 70, 80 & 106 Series - Business Class Conventional

	Models with O.E.M. Number	18-30378	OIO	83006
91 -	Trucks with Link Cabmate Models FRT153BC-A , FRT106BC or FRT106HD-A	1201-0054	OIO	83021
		1202-0054	OIO	83021





FL112 Conventional

97 -	FL112 Business Class Day Cab Tractors with Link Cabmate Model FRT112DC	1202-1044	OIO	83025
------	--	-----------	-----	--------------

FLA - COE Truck & Tractors

89 -	Cabover Tractors with 86", 96" & 104" Cabs with Link Cabmate Model FRT285	1202-0032	OIO	83016
	Models with O.E.M. Number	681-891-02-05	OIO	83017

APPLICATION GUIDE - TRUCKS, TRAILERS, AND BUSES

Year Año Année	Model Modelo Modèle	OEM #	Front		Rear	
						
			Fleetline	GasSLX	Fleetline	GasSLX

FREIGHTLINER CAB SHOCKS(Cont'd.)

FLB - COE Truck & Tractors(Cont'd.)

93 -	90", 100", & 110" Cabs with Link Cabmate Models FRT46-2P-A or FRT46-2P-B	1201-0054	010	83021
84 -	Cabover Tractors with 86", 96" & 104" Cabs with Link Cabmate Model FRT285	1202-0032	010	83016
	Cabover Tractors with the rear cab mounts having a center to center measurement of 50" or 54" & with Link Cabmate Models FRT50-2P-C	1202-0054	010	83021
84 -	Models with 86", 96" & 104" Cabs with Link Cabmate Model FRT285-A	1202-0022	010	83046

FLC - 112 & 120 Conventional Tractors

89 -	Conventional Tractors with Link Cabmate Model FRTE120-A	1201-1043 1202-1043	010 010	83025 83025
97 -	FL112 Models Business Class Day Cab Models with Link Cabmate Model FRT112DC	1201-1044	010	83025
- 03/88	Models with Link Cabmate FRTC120-A or FRTC120-AW Air Suspension	1201-0012 1202-0012	010 010	83023 83023

FLD 112 & 120 Conventional Truck & Tractor

	FLD Sleeper with Air Suspension	18-29846-000	010	83009
--	---------------------------------	--------------	-----	-------

FLD Series - 112 & 120 Conventional Truck & Tractor

09/93 -	64" Able Body Sleepers with Link Bunkmate Models FRTA64 or FRTAS64-A	1202-1044	010	83025
89 -	Conventional Tractors with Link Cabmate Model FRTE120-A	1202-1043	010	83025
	D2 Cab	18-41762-001 18-60765-001 814903003486	010 010 010	83047 83047 83047
01 - 12	FLD Sleeper with Air Suspension	18-29846-001	010	83064
	FLD112 Daycab with Air Suspension	18-31476-000	010	83020

M2 - Business Class

03 - 10	Crew Cab Models with O.E.M. Number	18-43504-000 18-60768-000 814903003484	010 010 010	83057 83057 83057
02 - 16	Day Cab Models with Leaf Spring Suspensions	18-47349-000 18-60767-000 814903003483	010 010 010	83039 83039 83039
03 - 16	M2-112 Crew Cab Models with O.E.M. Number	18-41762-000 18-60764-000 814903003528	010 010 010	83038 83038 83038
02 - 17	Models with Spring Suspension	18-47350-000 18-60766-000 814903003482	010 010 010	83040 83040 83040

Severe Duty Series - 108SD, 114SD & 122SD

12 - 17	108 SD Models with O.E.M. Number	18-60766-000 814903003482	010 010	83040 83040
12 - 17	114 SD Models with O.E.M. Number	18-60766-000 814903003482	010 010	83040 83040
12 - 16	122 SD Crew Cab Models with O.E.M. Number	18-60764-000 814903003528	010 010	83038 83038

Additional Applications

	Models with 60" Sleeper w/ Link Bunkmate Model FRTS60-A	1202-1043	010	83025
	Models with Link Cab Suspension	1202-0042 1202-0043 1202-0044	010 010 010	83025 83032 83025

APPLICATION GUIDE - TRUCKS, TRAILERS, AND BUSES

Year Año Année	Model Modelo Modèle	OEM #	Front		Rear	
			Fleetline	GasSLX	Fleetline	GasSLX

FREIGHTLINER CAB SHOCKS(Cont'd.)





Additional Applications(Cont'd.)

Models with O.E.M. Number	18-42613-000	010				83033
	18-44321-000	010				83009
	18-45067-000	010				83034
	18-60295-000	010				83006
	18-60765-000	010				83038
	18-60769-000	010				83009
	18-60772-000	010				83026
	18-60773-000	01-				83027
	654739	010				83009
	654819	010				83001
	654831	010				83006
	654841	010				83020
	654990	010				83038
	659079	010				83040
	659080	010				83039
	659125	010				83047
	659178	010				83038
	659288	010				83006
	814903003496	010				83009
	GBL 650361	010				83017

FREIGHTLINER CUSTOM CHASSIS

06 - 15	B2 Bus Chassis	10-13634-000	010	85918	89449	
		16-15817-000	010	010	85724	89443
		16-18708-000	010	010	85724	89443
	F65 School bus chassis with 10,000 to 18,000 lb Suspension	10-13759-000	010	85006
		471700003009	010	85006
		6803230300	010	85006
		GBL665538	010	85006
	F65 School bus chassis with Taperleaf Spring	6803260000		01-	83120	...
		GBL654725		01-	83120	...
	FB 65 Models with O.E.M. Number	10-13358-000	010	85097
	FB Shuttle bus chassis with O.E.M. Number	16-16765-000	010	85006
		471700131775	010	85006
	FedEx Trucks with O.E.M. Number	MAE16950	010	83118
		P117146	010	83118
	Fleetwood Motor Home with O.E.M. Number	GBL 651375	010	83119
		RW24285	010	83119
06 - 08	Front - Engine Diesel Chassis (FRED Chassis)	16-18095-000		01-	85092	...
		16-18455-000	010	85918	89449	
		471700000467		01-	85092	...
		471700002726	010	85918	89449	
	MB55 & MT55 Models	16-17684-000	010	85058	89431	
	MB55 Chassis	16-17759-000	010	85919
		471700000447	010	85919
	MB55 Shuttle bus w/8000 lb. flat leaf front suspension	16-15676-000	010	85058	89431	
96 - 99	MC Chassis for Class A Motorhomes	654918	010	83118
		P117099		01-	83120	...
		P117146	010	83118
	MC Chassis with Hendrickson Softtek Front Suspension	16-18094-000	010	85959
		471700000466	010	85959





APPLICATION GUIDE - TRUCKS, TRAILERS, AND BUSES

Year Año Année	Model Modelo Modèle	OEM #	Front		Rear	
						
			Fleetline	GasSLX	Fleetline	GasSLX

FREIGHTLINER CUSTOM CHASSIS(Cont'd.)

	MC-L Chassis with 9,000 lb Suspension	16-18455-000 471700002726	○ ○	85918	89449	
			○ ○	85918	89449	
	M-Line Walk in Van with O.E.M. Number	MAE 16949 MAE 16950 P117099 P117146		○ -	83120	...
			○ ○	83118
				○ -	83120	...
			○ ○	83118
	MP 14 and MP 19 Chassis	16-15475-000	○ ○	83164
	MP14 and 19 (UPS)	P117253	○ ○	83116
	MT135	GBL654875		○ ○	83117	...
	MT45 Step Van - Rear - w/35" Front Spring	16-15394-000 16-15473-000 16-15474-000		○ -	83120	...
			○ ○	83157
			○ ○	83157
			○ ○	83164
	MT55 Step Van	16-15436-000 16-15705-000 16-15934-000 16-16262-000 16-16542-000		○ -	83154	...
				○ -	83120	...
				○ -	83120	...
				○ -	83120	...
				○ -	83154	...
	MT55 Step Van - w/35" Front Spring - w/38" Front Spring	16-15473-000 16-15474-000 16-15089-000	○ ○	83157
			○ ○	83157
			○ ○	83164
	MT55 Utility Van w/8000 lb. flat leaf front suspension	16-15676-000	○ ○	85058	89431	
	Oshkosh Motor Home with O.E.M. Number	1398980 GBL654875		83127	...	○ ○	83127	...
				○ ○	83117	...
	School Bus Chassis with 7,000 lb Suspension	10-13859-000 471700005079	○ ○	85005	89430	
			○ ○	85005	89430	
	Shuttle Bus Chassis	16-16082-000	○ ○	85043
	Step Van and Motorhome chassis with O.E.M. Number	16-15475-000	○ ○	83164
	Step Van Models with O.E.M. Number	16-19138-000 471700003011	○ ○	85058	89431	
			○ ○	85058	89431	
09-12	Type C School bus chassis with O.E.M. Number	16-18713-000 471700003070		○ -	85122	...
				○ -	85122	...
03 - 07	VC Chassis ADL200 Suspension w/ 20K Rear Rear Shock with O.E.M. Number ZF - IFS Front Suspension with 23,000 lb GVW or Greater	16-16873-000 471700131974 141700131809 16-16736-000 16-18103-000 481700000493		○ ○	85029	...
				○ ○	85029	...
				○ ○	85029	...
				○ ○	85029	...
			- -	85900
			- -	85900
93 - 04	VC Chassis (Up To 22000 lb GVW)	○ ○	83160
	XC & XB MotorHome Chassis with Neway AS-120, 10,500 lb Front Air Suspension	141700000377 16-18075-000	○ ○	83174
			○ ○	83174
	XC & XB MotorHome Chassis with Neway AS-120, 12,000 lb Front Air Suspension	141700000378 141700131975 16-16874-000 16-18076-000	○ ○	83160
			○ ○	83160
			○ ○	83160
			○ ○	83160
03 - 07	XC Chassis ADL200 Suspension w/ 20K Rear AS120 Front Suspension	16-16873-000 141700131810	○ ○	○ ○	85029	...
			○ ○	83160

APPLICATION GUIDE - TRUCKS, TRAILERS, AND BUSES

Year Año Année	Model Modelo Modèle	OEM #	Front		Rear	
			 Fleetline	 GasSLX	 Fleetline	 GasSLX

FREIGHTLINER CUSTOM CHASSIS(Cont'd.)

03 - 07	ADL200 Suspension w/ 20K Rear	16-16737-000	010	83160
		16-16874-000	010	83160
	Rear Shock with O.E.M. Number	141700131809		010	85029	...
		16-16736-000		010	85029	...
	ZF - IFS Front Suspension with 23,000 lb GVW or Greater	16-18103-000	-1-	85900
		481700000493	-1-	85900
93 - 04	XC Chassis (Up To 22000 lb GVW)	010	83160
	XC MotorHome Chassis with ZF- IFS, 12,000 lb Front Air Suspension	16-17144-000	-1-	85900
		16-17361-000	-1-	85900
		481700000477	-1-	85900
		481700131919	-1-	85900
00 - 02	XCS Chassis (22000 lb GVW) w/ O.E.M. Number	16-15592-000	01-	83154
		16-15755-000	010	85043
		16-16043-000	010	85043
01 - 02	XCS Chassis with Freightliner Rear Air Suspension	16-16093-000	010	83160
	Models with O.E.M. Number	16-14794-000		01-	83154	...
		16-16083-000		010	85331	...
		16-16836-000		01-	83154	...
		654953	010	85058	89431	
		659227	010	85058	89431	
		GBL 654870	010	83116
		GBL654918	010	83118
	Additional O.E.M. Interchanges	16-15805-000	01-			83120		
		1745500	010			89430		
		659104	010			85904		
		66554540I	010			89430		
		P116168	010			83117		





FRUEHAUF

	"L" Suspensions	UCD-006216-001		010	83203	89436
	"T" Suspensions	UCE-1295-901		010	85300	89419
	"T" Suspensions With Drop Frame (NT Construction)	UCF-8339-001		010	85321	...
		UCF-8339-002		010	85321	...
	All with Air Suspension and O.E.M. Number	UCE-1295-1		010	85300	89419
	All with Lift Axle	UCE-9399-1		010	83122	89406
	Model "T" Low Mount with 48 ft drop-deck trailer	010	85327	...
	Model UCA-5431	5352858		010	85305	...
	Model W24T1 Air Ride	UCE-2983-000		010	85322	...
		UCE-2983-001		010	85322	...
	Tractor & Trailer Lift Axle with O.E.M. Number	5116-117		010	83122	89406
	Models with O.E.M. Number	144-5910		010	85300	89419
		680117		010	85300	89419
		680298		010	85321	...
		UCA-01113		010	85304	...
		UCA-5431		010	85305	...
		UCD-6216-1		010	83203	89436
		UCE-2983-1		010	85322	...
		UEY 1124-001		010	85030	89440

FWD TRUCK

	Models with O.E.M. Number	450739	010	85302	89420	
--	---------------------------	--------	-----	-------	-------	--	-----	-----

APPLICATION GUIDE - TRUCKS, TRAILERS, AND BUSES

Year Año Année	Model Modelo Modèle	OEM #	Front		Rear	
						
			Fleetline	GasSLX	Fleetline	GasSLX

GENERAL TRAILER CO

	Models with Air Suspension	120-1		010	83125	...
	Additional O.E.M. Interchanges	12608	010	83125				

GILLIG BROS.

	Models with Neway Air Suspension with shock stamping	90045084		010	85968	...
	Models with Neway ARD-234 Models Truck & Tractor Air Suspension (ARD-234-6)	90044046		010	83123	89405
	Phantom Models (30 Foot) with O.E.M. Number	90-2164 SP1	01-	85723
00 - 11	Phantom Models with O.E.M. Number	90-2627		010	...	89461
	School Bus w/1" Mounting Pins	200-171		85304	...	010	85304	...
		53-176		85304	...	010	85304	...
	School Bus w/3/4" Mounting Pins	57113	010	83219
		57131		010	83216	...
	Transit Bus, Phantom 55, 40, TB40	53-14010		-1-	85318	...
		53-24685	01-	85723
		695110		-1-	85318	...
		90F-1912		-1-	85318	...
	Models with O.E.M. Number	1583470		010	85051	...
		695109	01-	85723
		82-01878		83122	...	010	83122	89406
		90044683		010	83122	89406
		90044769		010	83207	89407
		90044770		010	83207	89407
		90-1951-SP1		010	85734	...
		90-1968	010	85712
		90-2423	01-	85723
		H53-02132-14005	01-	85723
		H53-20415-006		010	85051	...
		MR6394	01-	85723
	Additional O.E.M. Interchanges	53-02132	01-	85723				
		53-02133-000	-1-	85318				
		53-13952-000	-1-	85722				
		53-14005-000	01-	85723				
		665568	010	85051				
		680009	010	85302 or 89420				
		680333	-1-	85708				
		70034	010	85302 or 89420				
		82-21542-000	010	85716				
		82-30159-000	-1-	85708				
		90-1908	01-	85723				

GMC TRUCK

		1591501		-1-	85722	...
--	--	---------	--	-----	-----	-----	--------------	-----





3500 & 4000 Series

60 - 62	3500, 4000, B-4000, L-4000, S-4000 with H-130, H-150 and 13800 Axles	010	83221	...
63 - 66	Truck and School Bus	010	85005	89430	010	83221	...

4500 Series

66 - 72	CE-4500, CS-4500 Conventional Cab with V-8 Gas or In-line 6 Gas Engines	22012096		83221	...	010	83221	...
		3192892		83221	...	010	83221	...
66 - 72	EG-4500, EM-4500, ES-4500 Cab/Cowl with V-6 Gas or Diesel or In-line 6 Gas Engines	3171068	010	83216

APPLICATION GUIDE - TRUCKS, TRAILERS, AND BUSES

Year Año Année	Model Modelo Modèle	OEM #	Front		Rear	
						
			Wrench	Wrench	Wrench	Wrench
			Fleetline	GasSLX	Fleetline	GasSLX

GMC TRUCK(Cont'd.)

4500 Series(Cont'd.)

66 - 72	EG-4500, EM-4500, ES-4500 Cab/Cowl with V-6 Gas or Diesel or In-line 6 Gas Engines	3192657 4940614 4963853 4963854 22012095 3171462 3192890	010	83216	...	010
			010	83216	...	010
			010	83216	...	010
			010	83216	...	010
				010	83126	89430
				010	83126	89430
				010	83126	89430
72 - 80	PS4620 P, 4650P Step Van (Walk-in) 3/4" Upper bolt	22002293 22007701 22012095 22012166 3192890 4940606 4975497	010	83126	89430	010
			010	83126	89430	010
			010	83126	89430	010
			010	83126	89430	010
			010	83126	89430	010
			010	83126	89430	010
			010	83126	89430	010
72 - 80	PS4620 P, 4650P Step Van (Walk-in) 5/8" Upper bolt	22007751	010	83303	...	010
72 - 80	PS4620 P, 4650P Step Van (Walk-in)	22012096 3192892		010	83221	...
				010	83221	...









5000 Series

60 - 62	5000, B-5000, L-5000, S-5000 with 1618 or 16802 Axle	010	83221	...
75 - 80	C Chassis - Conventional Cab	4975510	010	83221	...	010
76 - 89	C Chassis - Conventional Cab	22002294 22007752 22007757 22012096 22012196	010	83304	...	010
			010	83304	...	010
			010	83304	...	010
				010	83221	...
				010	83221	...
73 - 80	C, S Chassis - Conventional Cab	22007750 4975467 4975494	010	83207	89407	010
			010	83207	89407	010
			010	83207	89407	010
73 - 80	C,S Chassis - Conventional Cab and School Bus	22012096 3192892		010	83221	...
				010	83221	...
73 - 89	C,S Chassis - Conventional Cab and School Bus	22012095 22012166		010	83126	89430
				010	83126	89430
60 - 68	SP-5000, DSP-5000 School Bus	010	85302	89420	010	85307	...
63 - 66	Truck and School Bus	010	85005	89430	010
63 - 68	W-5000, BW-5000, DW-5000	010	85005	89430	010

5500 Series

66 - 72	CE-5500, CS-5500 Conventional Cab with V-8 Gas or In-line 6 Gas Engines	22012096 3192891 3192892		83221	...	010	83221	...
				83221	...	010	83221	...
				83221	...	010	83221	...
66 - 72	CG-5500, CM-5500, T-5500 Conventional & Tilt Cab with V-6 Gas or Diesel Engines	22012095 3192890 4940606	010	83126	89430	010
			010	83126	89430	010
			010	83126	89430	010
66 - 72	EG-5500, EM-5500, ES-5500 Cab/Cowl with 6 Cyl. Engines	3171068 3192657 4940614 4963853 4963854 22012095 3171462	010	83216	...	010
			010	83216	...	010
			010	83216	...	010
			010	83216	...	010
			010	83216	...	010
				010	83126	89430
				010	83126	89430

APPLICATION GUIDE - TRUCKS, TRAILERS, AND BUSES

Year Año Année	Model Modelo Modèle	OEM #	Front		Rear	
						
						
			Fleetline	GasSLX	Fleetline	GasSLX

GMC TRUCK(Cont'd.)

5500 Series(Cont'd.)

66 - 72	EG-5500, EM-5500, ES-5500 Cab/Cowl with 6 Cyl. Engines	3192890		OIO	83126	89430
60 - 68	LW-5500	OIO	85307
67 - 68	Truck and School Bus	OIO	85005	89430	OIO	83221	...
63 - 68	W-5500	OIO	85005	89430	





6000 Series

76 - 89	C Chassis - Conventional Cab	22002294	OIO	83304
		22007752	OIO	83304
		22007757	OIO	83304
75 - 80	C, S Chassis - Conventional Cab and School Bus	4975510	OIO	83221
79 - 89	C, S Chassis - Conventional Cab and School Bus	22002295	OIO	83303
		22007753	OIO	83303
		22017530	OIO	83303
		22017531	OIO	83303
73 - 75	C, S Chassis - Conventional Cab and School Bus - Exc. with 18500, 20800 & 23000 lb Rear Axle	22007750	OIO	83207	89407	
		4975467	OIO	83207	89407	
		4975494	OIO	83207	89407	
73 - 89	C, S Chassis - Conventional Cab and School Bus - Exc. with 18500, 20800 & 23000 lb Rear Axle	22012096		OIO	83221	...
		22012169		OIO	83221	...
		3192892		OIO	83221	...
73 - 89	C, S Chassis - Conventional Cab and School Bus with 18500, 20800 & 23000 lb Rear Axle	22012095		OIO	83126	89430
		22012166		OIO	83126	89430
		4940606		OIO	83126	89430
				OIO	83126	89430
73 - 80	C, S, T Chassis - Conventional & Tilt Cab and School Bus with 5000 & 7000 lb Axle	22002293	OIO	83126	89430	
		22007701	OIO	83126	89430	
		22007751	OIO	83303
		22012095	OIO	83126	89430	
		3192890	OIO	83126	89430	
		4940606	OIO	83126	89430	
		4940662	OIO	83126	89430	
		4975497	OIO	83126	89430	
63 - 68	DW - 6000	OIO	85005	89430	
60 - 68	L - 6000	OIO	85307
79 - 89	S Chassis - School Bus	22002294	OIO	83304
		22007702	OIO	83304
		22007752	OIO	83304
		22007757	OIO	83304
79 - 80	W Chassis - 72" BBC Steel Tilt Cab	22002293	OIO	83126	89430	
		22007751	OIO	83303

6500 Series

75 - 76	C, M Chassis - Conventional Cab	4975510	OIO	83221
76 - 89	C, M Chassis - Conventional Cab	22002294	OIO	83304
		22007752	OIO	83304
		22007757	OIO	83304
73 - 75	C, M Chassis - Conventional Cab with 9000 & 12000 lb Axle	22012095	OIO	83126	89430	
		3192890	OIO	83126	89430	
		4940606	OIO	83126	89430	
		4940614	OIO	83216
		4963854	OIO	83216

APPLICATION GUIDE - TRUCKS, TRAILERS, AND BUSES

Year Año Année	Model Modelo Modèle	OEM #	Front		Rear	
						
			Fleetline	GasSLX	Fleetline	GasSLX

GMC TRUCK(Cont'd.)





6500 Series(Cont'd.)

73 - 75	C, M Chassis - Conventional Cab with 9000 & 12000 lb Axle	4975497	OIO	83126	89430
75 - 89	C, M Chassis - Conventional Cab with 9000 & 12000 lb Axle	22002295	OIO	83303
		22007751	OIO	83303
		22017530	OIO	83303
		22017531	OIO	83303
73 - 75	C, M, S Chassis - Conventional Cab and School Bus	4975497	OIO	83207	89407
		4975494	OIO	83207	89407
		4975494	OIO	83207	89407
73 - 80	C, M, S Chassis - Conventional Cab and School Bus - Exc. with 20800 or 23000 lb Rear Axle	22012096		OIO	83221
		22012169		OIO	83221
		3192892		OIO	83221
73 - 80	C, M, S Chassis - Conventional Cab and School Bus with 20800 or 23000 lb Rear Axle	22012095		OIO	83126 89430
		22012166		OIO	83126 89430
		4940606		OIO	83126 89430
73 - 80	C, S, T Chassis - Conventional & Tilt Cab and School Bus	22002293	OIO	83126	89430
		22012095	OIO	83126	89430
		3192890	OIO	83126	89430
		4940606	OIO	83126	89430
66 - 72	CE-6500, CM-6500 Conventional Cab with V-6 Diesel or V-8 Gas Engine	3192892		OIO	83221
66 - 72	CE-6500, ME-6500 Conventional Cab with V-8 Gas Engine - Exc. 11000 lb Axle	22012096	OIO	83221
		3192891	OIO	83221
		3192892	OIO	83221
66 - 72	CE-6500, ME-6500 Conventional Cab with V-8 Gas Engine with 11000 lb Axle	22012095	OIO	83126	89430
		3192890	OIO	83126	89430
		4940606	OIO	83126	89430
66 - 72	CM-6500, TE-6500, TM-6500 Conventional Cab with V-6 Diesel or V-8 Gas Engine	22012095	OIO	83126	89430
		22012096		OIO	83221
		3192890	OIO	83126	89430
66 - 72	EG-6500, DM-6500, ES-6500 Cab/Cowl with V-6 Gas or Diesel or In-line 6 Gas Engines	3171068	OIO	83216
		3192657	OIO	83216
		4963853	OIO	83216
		22012095		OIO	83126 89430
		3171462		OIO	83126 89430
3192890		OIO	83126 89430		

7000 Series

79 - 89	C, M Chassis - 97" BBC Conventional Cab	22002294	OIO	83304
		22002295	OIO	83303
		22007752	OIO	83304
		22007753	OIO	83303
		22007757	OIO	83304
		22017530	OIO	83303
79 - 81	C, M Chassis - 97" BBC Conventional Cab - Exc. with 18500, 20800 & 23000 lb Rear Axle	22012096		OIO	83221
		22017531	OIO	83303

APPLICATION GUIDE - TRUCKS, TRAILERS, AND BUSES

Year Año Année	Model Modelo Modèle	OEM #	Front		Rear	
						
			Fleetline	GasSLX	Fleetline	GasSLX

GMC TRUCK(Cont'd.)

7000 Series(Cont'd.)

79 - 81	C, M Chassis - 97" BBC Conventional Cab - Exc. with 18500, 20800 & 23000 lb Rear Axle	2212169		010	83221	...
79 - 89	C, M Chassis - 97" BBC Conventional Cab with 18500, 20800 & 23000 lb Rear Axle	22012095		010	83126	89430
		22012166		010	83126	89430
79 - 80	W Chassis - 72" BBC Steel Tilt Cab	22002293	010	83126	89430	
		22007751	010	83303

7500 Series

66 - 69	72" BBC Tilt Cab	22012095	010	83126	89430	
		3171462	010	83126	89430	
		4940606	010	83126	89430	
66 - 72	72" BBC Tilt Cab with V-6 2 Cycle Diesel Engine with 17221 Axle	22012096		010	83221	...
		3192892		010	83221	...
66 - 72	72" BBC Tilt Cab with V-6 2 Cycle Diesel Engine with 19101 and 19201 Axle	4940600		010	83209	89414
70 - 72	72" BBC Tilt Cab with Air Brakes - Exc. Gas Engine	22012095	010	83126	89430	
		3171462	010	83126	89430	
		4940606	010	83126	89430	
70 - 72	72" BBC Tilt Cab with Air Brakes & Gas Engine	22012091	010	85303	89422	
		5552452	010	85303	89422	
66 - 72	92" BBC Conventional Cab with Tapered 2-Leaf Softride 11000 lb Rating and F120 Axle (12000 lb)	22046483	010	85304
		22052336	010	85304
		3171069	010	85304
66 - 72	92" BBC Conventional Cab with Tapered 2-Leaf Softride 7000 & 9000 lb Rating and F070, F090, F120 Axle (7000, 9000 & 12000 lb)	3171068	010	83216
		3192657	010	83216
		4940614	010	83216
		4963853	010	83216
		4963854	010	83216
77 - 80	H, J Chassis - 92" BBC Conventional Cab	4963854	010	83216
		4984526	010	83216
73 - 80	H, J, M Chassis - 92" & 114" BBC Conventional Cab	22046483	010	85304
		22052336	010	85304
		3171069	010	85304
73 - 80	H, J, M Chassis - 92" & 114" BBC Conventional Cab with V-6, V-8 Gas or V-6 Diesel Engines	4940614	010	83216
		4963854	010	83216
73 - 80	R Chassis - Rear Engine Bus	22012090	010	85308	89422	
		22012091		010	85303	89422
		5552451	010	85308	89422	
		5552452		010	85303	89422
		5552456		010	85307	...
73 - 80	T, W Chassis - 72" BBC Steel Tilt Cab with V-6 Diesel Engine	22007751	010	83303
		22012095	010	83126	89430	
		4940606	010	83126	89430	
		4975497	010	83126	89430	
73 - 80	T, W Chassis - 72" BBC Steel Tilt Cab with V-6 Gas Engine	22012091	010	85303	89422	
		5552452	010	85303	89422	

8500 Series

66 - 72	72" BBC Tilt Cab	5544060	010	85302	89420	
67	92" BBC Conventional Cab	3171068	010	83216

APPLICATION GUIDE - TRUCKS, TRAILERS, AND BUSES

Year Año Année	Model Modelo Modèle	OEM #	Front		Rear	
			Fleetline	GasSLX	Fleetline	GasSLX

GMC TRUCK(Cont'd.)









8500 Series(Cont'd.)

67	92" BBC Conventional Cab	3192657	010	83216
		4940614	010	83216
		4963853	010	83216
		4963854	010	83216
66 - 72	92" BBC Conventional Cab with 7000 & 9000 lb Axles	22046483	010	85304
		22052336	010	85304
		3171069	010	85304
79 - 80	D, F Chassis - 54" BBC Aluminum Tilt Cab	22046483	010	85304
		22052336	010	85304
		3171069	010	85304
79 - 82	H, J Chassis - 92" BBC Conventional Cab 4 x 2 with Air Suspension	22012065		010	85304	...
		22046483		010	85304	...
		22052336		010	85304	...
		3171069		010	85304	...
73 - 81	H, J Chassis - 92" BBC Conventional Cab with V-6, V-8 Gas Engine	4940614	010	83216
		4963854	010	83216
		4984526	010	83216
73 - 86	H, J, M Chassis - 92" & 114" BBC Conventional Cab	22046483	010	85304
		22052336	010	85304
		3171069	010	85304
73 - 80	R Chassis - Rear Engine Bus	22012090	010	85308	89422	
		22012091		010	85303	89422
		5552451	010	85308	89422	
		5552452		010	85303	89422
73 - 80	T, W Chassis - 72" BBC Steel Tilt Cab with V-6 Gas Engine	22012091	010	85303	89422	
		5552452	010	85303	89422	

9500 Series

66 - 72	48" BBC Aluminum Tilt Cab	5552454	010	85302	89420	
66 - 72	72" BBC Steel Tilt Cab	22012091	010	85303	89422	
		5552452	010	85303	89422	
67 - 72	92" & 114" BBC Conventional Cab	3171068	010	83216
		3192657	010	83216
		4940614	010	83216
		4963853	010	83216
		4963854	010	83216
73 - 89	D, F Chassis - 54" BBC Aluminum Tilt Cab with Rear GM Air Ride Suspension (4 Req'd)	22012065		85304	...	010	85304	...
		22046483		85304	...	010	85304	...
		22052336		85304	...	010	85304	...
		3171069		85304	...	010	85304	...
73 - 89	H, J Chassis - 92" BBC Conventional Cab with Rear GM Air-Ride Suspension (4 req'd)	22012065		85304	...	010	85304	...
		22046483		85304	...	010	85304	...
		22052336		85304	...	010	85304	...
		3171069		85304	...	010	85304	...
77 - 89	M, N Chassis - 114" BBC Conventional & 108" BBC Aluminum Conventional Cab with Rear GM Air-Ride Suspension (4 req'd)	22046483		85304	...	010	85304	...
		22052336		85304	...	010	85304	...
		3171069		85304	...	010	85304	...
73 - 80	T, W Chassis - 72" BBC Steel Tilt Cab	22012091	010	85303	89422	

APPLICATION GUIDE - TRUCKS, TRAILERS, AND BUSES

Year Año Année	Model Modelo Modèle	OEM #	Front		Rear	
						
						
			Fleetline	GasSLX	Fleetline	GasSLX

GMC TRUCK(Cont'd.)

9500 Series(Cont'd.)

73 - 80	T, W Chassis - 72" BBC Steel Tilt Cab	5552452	○ ○	85303	89422	
----------------	---------------------------------------	---------	-----	--------------	--------------	--	-----	-----

B - Series - School Bus

90 - 98	B7 Model School Bus Chassis w/11000, 13500, 15000 lb Taperleaf Springs	22064231		- -	85324	...
90 - 06	B7 Model School Bus Chassis w/15000, 19000, 21000 lb Multileaf Springs	15174902		- -	85071	...
		22064232		- -	85071	...
- 09	B6 , B7 Models with O.E.M. Number	15123676	- -	83136
		15588554	- -	83136
		22064230	- -	83136
		88982682	- -	83136





C - Series (C4500, C5500) Topkick

04 - 09	C Chassis - Conventional Cab (Non 4x4 Option) with 13,500 Multi-leaf Spring	15185644		○ ○	83155	...
		508-89		○ ○	83155	...
		L-12706		○ ○	83155	...
90 -	C Chassis - Conventional Cab with 11000, 13500, 15000 lb Taperleaf Springs	22064231		- -	85324	...
90 - 09	C Chassis - Conventional Cab with 15000, 19000, 21000 lb Multileaf Springs	15174902		- -	85071	...
		22064232		- -	85071	...
		88982686		- -	85071	...
90 - 06	C Chassis - Conventional Cab with 16900 or 17850 lb Taperleaf Springs	21998392		- -	85336	...
		22064489		- -	85336	...
		88963409		- -	85336	...
90 -	C Chassis - Conventional Cab with 19000, 21000, 23000 lb Taperleaf Springs (EXC Low Profile Vehicle)	22064233		- -	83136	...
83 - 99	C Chassis - Conventional Cab with 9100 to 17500 lb Rear Axle	22064432		○ ○	85050	...
90 - 09	C Chassis - Conventional Cab with Front Shock with O.E.M. Number	15123676	- -	83136
		15588554	- -	83136
		15887728	- -	83136
		19152843	- -	83136
		22064230	- -	83136
		88982682	- -	83136
03 - 09	C Chassis - Conventional Cab with Taperleaf Rear Suspension	15185643		○ ○	83153	...
	Models with O.E.M. Number	88982684	- -	83136
		88982688		- -	85336	...

C - Series (C6500, C7500, C8500) Topkick

90 - 09	Conventional Cab	15123676	- -	83136
	Front Shock with O.E.M. Number	15174898	- -	83136
		15588554	- -	83136
		15887728	- -	83136
		19152843	- -	83136
		22064230	- -	83136
		88982682	- -	83136
	With 15000, 19000, 21000 lb Multileaf Springs	15174902		- -	85071	...
		22064232		- -	85071	...
		88982686		- -	85071	...
04 - 08	Conventional Cab (Low Profile) with 12000, 15000, & 17000 lb Leaf Spring	15174901		- -	85342	...
		507-22		- -	85342	...

APPLICATION GUIDE - TRUCKS, TRAILERS, AND BUSES

Year Año Année	Model Modelo Modèle	OEM #	Front		Rear	
			 Fleetline	 GasSLX	 Fleetline	 GasSLX

GMC TRUCK(Cont'd.)

C - Series (C6500, C7500, C8500) Topkick(Cont'd.)

04 - 08	Conventional Cab (Low Profile) with 12000, 15000, & 17000 lb Leaf Spring	88982685	- -	85342	...
90 -	Conventional Cab w/11000, 13500, 15000 lb Taperleaf Springs	22064231	- -	85324	...
90 - 06	Conventional Cab w/16900 or 17850 lb Taperleaf Springs	21998392	- -	85336	...
		22064489	- -	85336	...
		88963409	- -	85336	...
90 -	Conventional Cab w/19000, 21000, 23000 lb Taperleaf Springs (EXC Low Profile Vehicle)	22064233	- -	83136	...
04 - 08	Conventional Cab with 19000 lb Leaf Spring	15174903	- -	85342	...
		507-23	- -	85342	...
		88982687	- -	85342	...
83 - 99	Conventional Cab with 9100 to 17500 lb Rear Axle	22064432	0 0	85050	...
95 - 02	Models with Hendrickson Air Suspension (Stamping number 47902-13)	12474915	0 0	83122	89406
		15963161	0 0	83122	89406
96 - 02	Models with Hendrickson Air Suspension (Stamping number 47902-29)	12474917	0 0	83137	...
		15740554	0 0	83137	...
	Models with O.E.M. Number	88982684	- -	83136
		88982688	- -	85336	...

Coaches

	4100, 4900 Models	3182842	85711	...	- 0	85711	...
		3188599	85711	...	- 0	85711	...
		3192416	85711	...	- 0	85711	...
		4975552	85711	...	- 0	85711	...
	4500, 5300 Models	3166657	85700	...	0 0	85700	...
		3192333	85700	...	0 0	85700	...
	Models with O.E.M. Number	3175509	85735	...	0 0	85735	...
		3178106	85700	...	0 0	85700	...
		3178507	85700	...	0 0	85700	...
		3178995	85700	...	0 0	85700	...
		3189265	85700	...	0 0	85700	...
		5304059	85700	...	0 0	85700	...
		5316784	85700	...	0 0	85700	...
		5316794	85700	...	0 0	85700	...
		5316984	85313	...	0 0	85313	...
		5352857	85700	...	0 0	85700	...
		5527271	85700	...	0 0	85700	...
		5527272	85700	...	0 0	85700	...
		5549924	85700	...	0 0	85700	...





P - Series

92 - 96	Motorhome Chassis	22064231	- -	85324	...
		22064233	- -	83136	...

T - Series (T5500, T6500, T7500, T8500)

97 -	FL1 Tilt Cab with 8100 lb Axle	22064804	- -	83136
		22064805	- -	83136
		22165187	- -	83136
		22165188	- -	83136
97 -	FL2 Tilt Cab with 5000 to 11000 lb Axle	22064807	- -	83136
		22166442	- -	83136
97 -	FL3 Tilt Cab with 14575 lb Axle	22064806	- -	83136
		22165189	- -	83136

APPLICATION GUIDE - TRUCKS, TRAILERS, AND BUSES

Year Año Année	Model Modelo Modèle	OEM #	Front		Rear	
						
			Fleetline	GasSLX	Fleetline	GasSLX

GMC TRUCK(Cont'd.)



T - Series (T5500, T6500, T7500, T8500)(Cont'd.)

99	Models with Hendrickson Air Suspension (Stamping number 47902-13)	12474915	0 0	83122	89406
		15963161	0 0	83122	89406
06 - 09	Tilt Cab Models with O.E.M. Number	15174901	- -	85342	...
		15174903	- -	85342	...
		507-22	- -	85342	...
		507-23	- -	85342	...
		88982685	- -	85342	...
		88982687	- -	85342	...
90 - 99	Tilt Cab with 11000, 13500, 15000 lb Taperleaf Springs	22064231	- -	85324	...
90 - 06	Tilt Cab with 15000, 19000, 21000 lb Multileaf Springs	15174902	- -	85071	...
		22064232	- -	85071	...
92 - 06	Tilt Cab with 16900 lb Taperleaf Springs RR SUSP(GZH) Heavy Duty	21998392	- -	85336	...
		22064489	- -	85336	...
		88963409	- -	85336	...
92 - 99	Tilt Cab with 19000, 21000, 23000 lb Taperleaf Springs (EXC Low Profile Veh.)	22064233	- -	83136	...

W - Series (Isuzu)

	Models with O.E.M. Number	8-97253664-0	0 0	83159	...
		97253664	0 0	83159	...
83 - 95	W4 Models	8-51630-666-0	0 0	85012	89413
		9-51630-666-0	0 0	85012	89413
89 - 90	W4 Models Flatlow	9-51630-647-1	- 0	83515
89 - 92	W4 Models Flatlow	8-51630-666-0	0 0	85012	89413
86 - 09	W4 Models with 11000 lb & 13000 lb Suspension	8-94454-986-0	- 0	83515
		8-94454-987-0	- 0	83515
		8-97253-620-0	- 0	83515
		94454987	- 0	83515
		9-51630-647-1	- 0	83515
		97083027	- 0	83515
		97083029	- 0	83515
		97253620	- 0	83515
98232671	- 0	83515	
01 - 08	W4 Models with O.E.M. Number	97253651	0 0	83404	...
02 - 14	W4 Models with O.E.M. Number	8-97253665-0	0 0	83159	...
		898098-0580	0 0	83159	...
		898098-0581	0 0	83159	...
		898098-0590	0 0	83159	...
		97253665	0 0	83159	...
		98098058	0 0	83159	...
		98098059	0 0	83159	...
88 - 99	W5 Models	1-51630-217-0	- 0	83114
		1-51630-217-1	- 0	83114
		1-51630-219-1	- 0	83114
03 - 09	W5 Models with 11000 lb & 13000 lb Suspension	97253620	- 0	83515
03 - 09	W5 Models with O.E.M. Number	97253665	0 0	83159	...
86 - 91	W6 Models	1-51630-168-1	- 0	83515
		1-51630-217-1	- 0	83114
	Models with O.E.M. Number	8-94057-593-0	- 0	83114
		8-97083-029-0	- 0	83515
		8-97201-960-0	- 0	83515

APPLICATION GUIDE - TRUCKS, TRAILERS, AND BUSES

Year Año Année	Model Modelo Modèle	OEM #	Front		Rear	
						
			Fleetline	GasSLX	Fleetline	GasSLX

GMC TRUCK(Cont'd.)

W - Series (Isuzu)(Cont'd.)

Models with O.E.M. Number	898098-1250	-10	83515
	898098-1270	-10	83515
	90044769		010	83207	89407
	90044770		010	83207	89407
	94033786		-10	83114	...
	94051090	-10	83114
	94057593	-10	83114
	94454987	-10	83515
	9-51630-666-2		010	85012	89413
	97201960	-10	83515
	97253616	-10	83515
	97253621	-10	83515
	97253623	-10	83515
	98098125	-10	83515
	98098127	-10	83515

WCA & WIA Series

Models with O.E.M. Number	37301-0016	01-	85026	89417	
	37301-0021	01-	85026	89417	
	37301-3202	01-	85026	89417	

WH Series

WHS, WHR, WHL or WHE Models with Front Dual Shocks	3082284	-1-	83400
--	---------	-----	--------------	-----	--	-----	-----





Additional Applications

1500 Models							
Models with Rear Suspension	35901-0005		010	83219	...
Models with O.E.M. Number	35901-0001		010	83209	89414

Additional O.E.M. Interchanges

Models with O.E.M. Number	15642943		-1-	83136	...	
	22024061		010	85704	...	
	22025067		010	85704	...	
	22025305		010	85704	...	
	22046489	010	85303	89422		
	22065218	010	G63347	
	22065251	010	85030	89440		
	22099889		-1-	85336	...	
	507-24		-1-	85336	...	
	508-88		010	83153	...	
	87-2520-00003		010	85704	...	
	U0109-014		-1-	83400	...	
	Additional O.E.M. Interchanges	22007703	010				83303	
		22012067	010				85700	
		22012079	-1-				85701	
22012082		010				85702		
22012083		-10				85711		
22012083GS		-10				85711		
22012114		010				85700		
22012131		-10				85711		
22024062		-1-				85701		
22024673		-10				85710		
22045526		010				85702		
22046481		010				85702		
22046485		-10				85710		

APPLICATION GUIDE - TRUCKS, TRAILERS, AND BUSES





Year Año Année	Model Modelo Modèle	OEM #	Front		Rear	
						
			Fleetline	GasSLX	Fleetline	GasSLX

GMC TRUCK(Cont'd.)

Additional O.E.M. Interchanges(Cont'd.)

Additional O.E.M. Interchanges	OEM #	Interchange	Replacement
	22046499	-10	85710
	22052014	010	85702
	22052424	-10	85710
	3171696	010	85307
	3172948	010	85303 or 89422
	3178157	010	85700
	3178233	010	85734
	3188626	010	85300 or 89419
	3188729	010	85303 or 89422
	35901-0003	010	85301
	35901-0004	010	83219
	35901-0017	010	83314
	4939852	010	85308 or 89422
	4939967	010	85308 or 89422
	4940601	010	83216
	4940627	010	83203 or 89436
	4940640	010	83216
	4940650	010	83207 or 89407
	4940654	010	83216
	4940660	010	83207 or 89407
	4963844	010	85307
	4964853	010	83217
	4974401	010	85700
	4975429	010	85300 or 89419
	4975472	-10	83161
	4975479	-1-	83400
	4975480	-1-	83400
	4975501	010	85700
	4975515	-1-	85701
	4975516	010	85702
	4975518	010	85704
	4975538	010	85700
	4975549	010	83216
	4975550	010	85702
	507-12	-1-	85701
	507-16	010	85702
	507-19	010	85700
	5171068	010	83216
	5316791	010	83219
	5316792	010	85305
	5316793	010	85305
	5321920	010	85307
	5321929	010	85307
	5348631	010	83203 or 89436
	5352858	010	85305
	5353054	010	85303 or 89422
	5355798	010	85307
	5357955	010	85300 or 89419
	5357956	010	85734
	5357959	010	85300 or 89419
	5361994	010	85734

APPLICATION GUIDE - TRUCKS, TRAILERS, AND BUSES









Year Año Année	Model Modelo Modèle	OEM #	Front		Rear	
						
			Fleetline	GasSLX	Fleetline	GasSLX

GMC TRUCK(Cont'd.)

Additional O.E.M. Interchanges(Cont'd.)

Additional O.E.M. Interchanges	OEM #	Interchange
	5374779	010 85308 or 89422
	5374999	010 85307
	5385939	010 85307
	5392387	010 85303 or 89422
	5394448	010 85305
	5394467	010 85305
	5394468	010 85735
	5455798	010 85307
	5513489	010 83216
	5513716	010 85304
	5516459	010 85305
	5522781	010 85735
	5522794	010 85308 or 89422
	5522818	010 85305
	5527001	010 85300 or 89419
	5527606	010 85305
	5531027	010 85301
	5531435	010 85307
	5531436	010 85307
	5531437	010 85307
	5532026	010 85304
	5532425	010 83207 or 89407
	5532433	010 83207 or 89407
	5532675	010 85307
	5533699	010 85302 or 89420
	5534430	010 85303 or 89422
	5534439	010 85304
	5534447	010 85303 or 89422
	5544112	010 83216
	5544581	010 85302 or 89420
	5544716	010 85304
	5544717	010 85304
	5544812	010 83308
	5544818	010 85735
	5549899	010 83207 or 89407
	5549925	010 85304
	5552111	010 85304
	5552112	010 85307
	5552114	010 83216
	5552205	010 83217
	5552206	010 83214
	5552207	010 83217
	5552208	010 83217
	5552209	010 83215
	5552210	010 85308 or 89422
	5552244	010 85308 or 89422
	5552285	010 83214
	5552286	010 83217
	5552287	010 83217
	5552288	010 83217
	5552453	010 85301

APPLICATION GUIDE - TRUCKS, TRAILERS, AND BUSES

Year Año Année	Model Modelo Modèle	OEM #	Front		Rear	
						
						
			Fleetline	GasSLX	Fleetline	GasSLX

GMC TRUCK(Cont'd.)

Additional O.E.M. Interchanges(Cont'd.)

Additional O.E.M. Interchanges	OEM #	OEM #	OEM #	OEM #	OEM #
	5552527	010			85735
	5554184	010			85302 or 89420
	5554589	010			85307
	5554596	010			85303 or 89422
	5554814	010			85302 or 89420
	5554959	010			83401
	5554995	010			85305
	5559363	010			83203 or 89436
	5585939	010			85307
	684280	010			83209 or 89414
	97-2210-00153	-1-			85701
	97-2210-00156	010			85702
	97-2210-00164	-1-			85708
	97-2210-00170	01-			85733

GMC TRUCK CAB SHOCKS

Description	OEM #	OEM #	OEM #	OEM #	OEM #
Astro Cabover (Sleeper & Non-Sleeper Trucks) with Link Cabmate Model GMC-2P-A	1202-0032	010			83016
Brigadier Tractors with J9 Cabs with Link Cabmate Model GMC92J9	1202-0012	010			83023
03 - C4500 , C5500 Models Models with Link Cabmate Model GMT560	1201-1043	010			83025
	1202-1043	010			83025
79 - Conventional Trucks measuring 108" BBC or 116" BBC with Link Cabmate Model GMC816	1202-0012	010			83023
	Models with Link Cab Suspension	1202-0022	010		83046
90 - TopKick Truck Cabs with Link Cabmate Model GMC104TK	1202-0054	010			83021
- 89 TopKick Truck Cabs with Link Cabmate Model GMC92TK	1202-0012	010			83023

GRANNING SUSPENSION

Description	OEM #	OEM #	OEM #	OEM #	OEM #
Models T950-1200, -1400, -1700	2697		010 85712 ...
Models with O.E.M. Number	1085		010 83214 ...
	680162		010 85300 89419
	OE12425		010 83214 ...
			010 83214 ...

GREAT DANE TRAILER

Description	OEM #	OEM #	OEM #	OEM #	OEM #
Identification of the trailer suspension is necessary to determine what section of the catalog to refer to. Some possible options can be Chalmers, Hendrickson, Neway, Ridewell, Reyco.					
Reyco Suspension 87	18163-01		010 83207 89407
Reyco Suspension 88	18164-01		010 83122 89406
Trailers with Great Dane part number	HENS-20001		010 83128 89436
	HENS-20002		010 85000 89436
	HENS-20126		010 85323 89436
	HENS-21292		010 85052 ...
	HENS-23566		010 85000 89436
	HENS-23649		010 85064 ...
	MER202447		010 85919 ...
	REY18165-01		010 85006 ...
Trailers with Great Dane part number Heavy Duty	HENS-24088		010 85000 89436
	HENS-24088		010 83128 89436
Trailers with Reyco 86 AR / RS 1015, 1035, 3035 Slider Air Suspension	18165-01		010 85006 ...

APPLICATION GUIDE - TRUCKS, TRAILERS, AND BUSES

Year Año Année	Model Modelo Modèle	OEM #	Front			Rear		
			Fleetline	GasSLX	Fleetline	GasSLX		

GREYHOUND BUS

	City Cruiser	12TA-01-013		85303	...	010	85303	89422
	MC5, MC7, MC8	12B-5-1		85735	...	010	85735	...
		3178157		85700	...	010	85700	...
	Additional O.E.M. Interchanges	3166657	010	85700				
		3178154	010	85735				
		3192333	010	85700				
		690029	010	85700				
		74413	010	85313				

GRUMMAN BUS





	Model 870 Flex Bus	22024506	-10	85703
		22025066	-10	85703
		22025067		010	85704	...
		22025305		010	85704	...
		97-2201-00001	-10	85703
		97-2201-00002	-10	85703
		97-2201-00003	-10	85703
		97-2201-00004	-10	85703
		97-2201-00005	-10	85703
		97-2210-00001		010	85704	...
		97-2210-00002		010	85704	...
		97-2210-00003		010	85704	...
		97-2210-00004		010	85704	...
		97-2210-00005		010	85704	...
	Additional O.E.M. Interchanges	690029	010	85700				

GULF STREAM COACH

Class A MotorHomes

03 - 06	Atrium Series MotorHomes with Freightliner XC Chassis ADL200 Suspension w/ 20K Rear AS120 Front Suspension Rear Shock with O.E.M. Number ZF - IFS Front Suspension with 23,000 lb GVW or Greater	16-16873-000						
		141700131810	010	83160
		16-16737-000	010	83160
		16-16874-000	010	83160
		141700131809		010	85029	...
		16-16736-000		010	85029	...
		16-18103-000	-1-	85900
		481700000493	-1-	85900
				010	85029	...
				83160
02 - 06	Friendship & Scenic Cruiser Series MotorHomes with Freightliner XC Chassis ADL200 Suspension w/ 20K Rear AS120 Front Suspension Rear Shock with O.E.M. Number ZF - IFS Front Suspension with 23,000 lb GVW or Greater	16-16873-000						
		141700131810	010	83160
		16-16737-000	010	83160
		16-16874-000	010	83160
		141700131809		010	85029	...
		16-16736-000		010	85029	...
		16-18103-000	-1-	85900
		481700000493	-1-	85900
				010	85029	...
				83160
02	Independence Series MotorHomes with Freightliner XC Chassis ADL200 Suspension w/ 20K Rear AS120 Front Suspension	16-16873-000						
		141700131810	010	83160
		16-16737-000	010	83160

APPLICATION GUIDE - TRUCKS, TRAILERS, AND BUSES

Year Año Année	Model Modelo Modèle	OEM #	Front		Rear	
						
			Fleetline	GasSLX	Fleetline	GasSLX

GULF STREAM COACH(Cont'd.)

Class A MotorHomes(Cont'd.)

02	ADL200 Suspension w/ 20K Rear	16-16874-000	0 0	83160
	Rear Shock with O.E.M. Number	141700131809		0 0	85029	...
		16-16736-000		0 0	85029	...
	ZF - IFS Front Suspension with 23,000 lb GVW or Greater	16-18103-000	- -	85900
		481700000493	- -	85900
02 - 04	Yellowstone Series MotorHomes with Freightliner XC Chassis							
	ADL200 Suspension w/ 20K Rear	16-16873-000		0 0	85029	...
	AS120 Front Suspension	141700131810	0 0	83160
		16-16737-000	0 0	83160
		16-16874-000	0 0	83160
	Rear Shock with O.E.M. Number	141700131809		0 0	85029	...
		16-16736-000		0 0	85029	...
	ZF - IFS Front Suspension with 23,000 lb GVW or Greater	16-18103-000	- -	85900
		481700000493	- -	85900

HARDEE MFG

Models with O.E.M. Number	8030223		0 0	83207	89407
	AS789B		0 0	85014	...

HAUSMAN





Models with O.E.M. Number	695110		- -	85318	...
	695119		0 0	85702	...
	695198		- -	85706	...

HENDRICKSON TRAILER SUSPENSION SYSTEMS

Intraax

AA230T & AA250T Models with O.E.M. Number	A-20002		0 0	85000	89436
	A-20126		0 0	85323	89436
	A-20889		0 0	85323	89436
	B-22345		0 0	85911	...
AAEDL Models For Models with 12" Ride Height For Models with 14" to 19" Ride Height For Models with 9" Ride Height	B-24023		0 0	85738	...
	B-23316		0 0	85382	...
	B-24579		0 0	85939	...
AAEDT 30K Models (w/14" and 15" Ride Height- High Damping) (w/14" Ride Height) (w/15", 16" & 17" Ride Height)	B-25436		0 0	85916	89430
	B-23361		0 0	85911	...
	B-25515		0 0	85338	...
AAL 23K, 25K & 30K Models Front shocks with 12" Ride Height Front shocks with 14" to 19" Ride Height Front shocks with 6.5" to 9" Ride Height Rear shocks with 14" to 17" Ride Height Rear shocks with 6.5" to 7.5" Ride Height Rear shocks with 9" to 12" Ride Height	B-23566		0 0	85000	89436
	A-2212		0 0	85029	...
	B-23651		0 0	85045	...
	B-25437		0 0	85337	...
	B-20345		0 0	85345	...
	B-25436		0 0	85916	89430
AANL 23K Models with 12" to 17" Ride Height - High Damping with 6.5" to 9" Ride Height - High Damping with 6.5" to 9" Ride Height - Standard	B-25515		0 0	85338	...
	B-24579		0 0	85939	...
	B-23651		0 0	85045	...
AANLS - 20K with Rear shocks with 9" Ride Height	B-23316		0 0	85382	...

APPLICATION GUIDE - TRUCKS, TRAILERS, AND BUSES

Year Año Année	Model Modelo Modèle	OEM #	Front		Rear	
						
			Fleetline	GasSLX	Fleetline	GasSLX

HENDRICKSON TRAILER SUSPENSION SYSTEMS(Cont'd.)









Intraax(Cont'd.)

AANT 23K Models (High Damping) (Hvy Duty) (Limited Rebound) (Standard)	B-24023	010	85738	...
	B-24125	010	85323	89436
	B-23361	010	85911	...
	B-23566	010	85000	89436
AAT 23K Models (High Damping) (Hvy Duty) (Limited Rebound) (Standard)	B-24023	010	85738	...
	B-24125	010	85323	89436
	B-23361	010	85911	...
	B-23566	010	85000	89436
AAT 25K Models (High Damping) (Hvy Duty) (Limited Rebound) (Standard)	B-24023	010	85738	...
	B-24125	010	85323	89436
	B-23361	010	85911	...
	B-23566	010	85000	89436
AAT 30K Models	B-24023	010	85738	...
AAZL 23K / 46K Models with 12" Ride Height - High Damping with 12" Ride Height - Standard with 6.5" to 9" Ride Height - High Damping with 6.5" to 9" Ride Height - Standard	B-24023	010	85738	...
	B-23566	010	85000	...
	B-24579	010	85939	...
	B-23651	010	85045	...
AAZNT 23K / 46K / 69K Models with 12" to 17" Ride Height - High Damping with 12" to 17" Ride Height - Standard	B-24023	010	85738	...
	B-23566	010	85000	...
Low Ride Height Models with (10.5" to 15" Ride Height) (15.5" to 21" Ride Height - High Damping) (15.5" to 21" Ride Height - Std Damping) (6.5" to 8" Ride Height - High Damping) (6.5" to 8" Ride Height)	B-23013	010	85000	89436
	B-23316	010	85382	...
	B-23315	010	85029	...
	B-22312	010	85939	...
	B-22311	010	85045	...

Top Mount Style

HT190T (All Models)	A-20001	010	83128	89436
HT230T All except Models listed below (TA14-020) (TA15-521, TA17-521) (TA15-522, TA17-522) (-14-020, -14-021, TA14-021) (-14-17, -15-17,-15-517,-17-517,TA15-517,TA15-520,TA17-517) (-14-7,-14-11, -15-7,-15-11,-15-12,-15-28,TA14-7,TA15-7,TA16-7,TA17-7,TB14-33,TB15-28)	A-20002	010	85000	89436
	B-22345	010	85911	...
	B-21553	010	85738	...
	B-21699	010	87018	...
	A-2212	010	85029	...
	A-20126	010	85323	89436
HT250T (All Models)	A-2212	010	85029	...
HT300T & N-HT300T (All except Models listed below) (-15-007, -15-011, -15-021,-17-007,-17-011, -17-012, TB19-007,TB19-020) (-15-017, -15-518, -17-518,-17-520) (TB15-027) (TB15-518)	A-20126	010	85323	89436
	A-2160	010	85014	...
	B-21553	010	85738	...
	B-24579	010	85939	...
	B-21699	010	87018	...
T-15-140, -155, -172, 244, -376	A-2218	010	85030	89440
T-15-324	A-2160	010	85014	...

APPLICATION GUIDE - TRUCKS, TRAILERS, AND BUSES

Year Año Année	Model Modelo Modèle	OEM #	Front		Rear	
						
						
			Fleetline	GasSLX	Fleetline	GasSLX

HENDRICKSON TRAILER SUSPENSION SYSTEMS(Cont'd.)





Top Mount Style(Cont'd.)

T-17-141, -174, -284	A-2218	010	85030	89440
TMB-14-120	A-2213	010	85010	...
TMB-17-135	A-4084	010	85005	89430

UnderSlung Style

HT190U (-6.75-001 / -6.75-002 / -6.75-003 / -6.75-020) (U-7.5-517) (U-9-022 / UB7-021) (All except Models listed above)	A-2212	010	85029	...
	A-20002	010	85000	89436
	B-23649	010	85064	...
	A-20001	010	83128	89436
HT250U & N-HT250U (All except Models listed below) (U-6.5-030, U-6.5-031) (U-6.5-27, U-9-27 & -28, U-14-28, UB6.5-522, UB7.5-27 &-522, UB9-522, UB12-27 &-28, UB14-27 &-28) (U-6.5-517, U-7.5-17, U-7.5-517, U-9-517, U-12-517, U-14-514, UB6.5-517, UB7.5-517) (U-7.5-021, U-7.5-022) (U-9-20 & -21 & -23, U-9.5-26, U-15-22, UB9-22, UB15-22)	A-20002	010	85000	89436
	A-2160	010	85014	...
	B-21553	010	85738	...
	A-20126	010	85323	89436
HT250US - 5.5 to 6.5" Ride Height (High Damping)	B-23744	010	85344	...
	S-23744	010	85344	...
HT250US (Models with Angled and Frame Clearance Mount) (Standard Travel w/ 6.5", 7.5" & 14" Ride Height -High Damping) (Standard Travel w/ 6.5", 7.5" & 14" Ride Height)	B-24579	010	85939	...
	B-23651	010	85045	...
HT250US (Models with O.E.M. Number)	B-21936	010	85064	...
	B-21947	010	85052	...
	B-22862	010	85045	...
HT250US (Models with Remote Shock Mount) (Extended Rebound w/ 6.5" to 9" Ride Height -High Damping) (Extended Rebound w/ 6.5" to 9" Ride Height) (Standard Travel w/ 12" to 14" Ride Height) (Standard Travel w/ 5.5" to 6.5" Ride Height) (Standard Travel w/ 7.5" to 9" Ride Height -High Damping) (Standard Travel w/ 7.5" to 9" Ride Height)	B-23316	010	85382	...
	A-2212	010	85029	...
	A-2212	010	85029	...
	B-23650	010	85052	...
	B-23743	010	85938	...
HT250US (Models with Standard Shock Mount) (Extended Rebound w/ 6.5" Ride Height -High Damping) (Extended Rebound w/ 6.5" Ride Height) (Standard Travel w/ 3.5" to 4" Ride Height) (Standard Travel w/ 5.5" to 6.5" Ride Height) (Standard Travel w/ 7.5" to 14" Ride Height -High Damping) (Standard Travel w/ 7.5" to 14" Ride Height)	B-24579	010	85939	...
	B-23651	010	85045	...
	B-23548	010	85079	...
	B-23650	010	85052	...
	B-23743	010	85938	...
	B-23649	010	85064	...
HT250U-Y (All Models)	A-20002	010	85000	89436
HT300U & N-HT300U (All except Models listed below) (U-7.5-519, U-9-011, U-9-519, U-12-011, U-12-015, U-14-011, U-14-015, U-17-011)	A-20126	010	85323	89436
	B-21699	010	87018	...
T-12-139	A-2213	010	85010	...
T-23-US-9-011	A-2213	010	85010	...
T30-US-9, -17	A-10348	010	85043	...
T-4-392	A-2160	010	85014	...
T-6-062, -295, -370, -422	A-1667	010	85000	89436
T-6-071	A-2212	010	85029	...

APPLICATION GUIDE - TRUCKS, TRAILERS, AND BUSES

Year Año Année	Model Modelo Modèle	OEM #	Front		Rear	
						
			Fleetline	GasSLX	Fleetline	GasSLX

HENDRICKSON TRAILER SUSPENSION SYSTEMS(Cont'd.)

UnderSlung Style(Cont'd.)

T-9-084	A-2240		010	85013	89414
T-9-106, -278, -313	A-4084		010	85005	89430
T-9-175	A-2160		010	85014	...
T-9-325	A-2218		010	85030	89440
T-9-390	A-2213		010	85010	...

Vantraax

HKA180 Heavy Duty	B-24088		010	85000	89436	
	S-24088		010	85000	89436	
	Standard	B-24088		010	83128	89436
		S-24088		010	83128	89436
HKA200	B-23566		010	85000	89436	
	S-23566		010	85000	89436	
HKA250 (Standard)	B-24023		010	85738	...	
HKAL 46K Models	B-23566		010	85000	89436	
HKANT 40K Heavy Duty	B-24088		010	85000	89436	
	S-24088		010	85000	89436	
	Standard	B-24088		010	83128	89436
		S-24088		010	83128	89436
HKANT 46K	B-23566		010	85000	89436	
	S-23566		010	85000	89436	
HKANT 69K23	S-23566		010	85000	89436	
	S-23566		010	85000	89436	
HKARL 46K Disc Brake Applications	B-25436		010	85916	89430	
	S-25436		010	85916	89430	
	Drum Brake Applications	B-23566		010	85000	89436
		S-23566		010	85000	89436
HKAT 46K	B-23566		010	85000	89436	
	S-23566		010	85000	89436	
HKAT 50K	B-24023		010	85738	...	
	S-24023		010	85738	...	
HKAT 69K	B-24023		010	85738	...	
	S-24023		010	85738	...	





Additional Applications

AB-32-001 Models	A-1667		010	85000	89436
HK190T (Slider Air Suspension)	A-21292		010	85052	...
HK230 (Slider Air Suspension)	A-21292		010	85052	...
HS190T (Slider Air Suspension)	A-20001		010	83128	89436
HS230 (Slider Air Suspension)	A-20002		010	85000	89436
MT-45,MTL45,MTL-50	S-1667		010	85000	89436
TDC-014	665267		010	85029	...
	A-2212		010	85029	...

Additional O.E.M. Interchanges

Models with O.E.M. Number	57905-2		010	85006	...
	60675-004		010	85006	...
	654951		010	85000	89436
	659024		010	85052	...
	665190		010	85006	...

APPLICATION GUIDE - TRUCKS, TRAILERS, AND BUSES

Year Año Année	Model Modelo Modèle	OEM #	Front		Rear	
						
			Fleetline	GasSLX	Fleetline	GasSLX

HENDRICKSON TRAILER SUSPENSION SYSTEMS(Cont'd.)

Additional O.E.M. Interchanges(Cont'd.)

Models with O.E.M. Number							
665246	010	85043	...		
665405	010	85030	89440		
665406	010	85010	...		
665531	010	85000	89436		
665532	010	85013	89414		
665533	010	85005	89430		
665536	010	85000	89436		
665693	010	85064	...		
665694	010	85052	...		
665698	010	85911	...		
665733	010	85045	...		
665756	010	85000	89436		
665758	010	85064	...		
665759	010	85052	...		
665760	010	85045	...		
665761	010	85911	...		
665763	010	85079	...		
665764	010	85029	...		
665765	010	83150	...		
665766	010	85000	89436		
665767	010	85045	...		
671779	010	...	89414		
671948	010	85000	89436		
680102	010	85712	...		
680341	010	85323	89436		
680463	010	...	89440		
680467	010	85323	89436		
680509	010	85738	...		
680565	010	85738	...		
680566	010	85938	...		
680568	010	85323	89436		
680570	010	...	89437		
680571	010	85738	...		
680573	010	85939	...		
680579	010	85939	...		
680614	010	85338	...		
680616	010	...	89430		
680617	010	85337	...		
680702	010	85323	89436		
680756	010	85323	89436		
680769	010	85911	...		
680776	010	85338	...		
98583-019	010	85323	89436		
98583-020	010	...	89414		
A-10023	010	85000	89436		
A-11931	010	85000	89436		
A-14583	010	85000	89436		
A-1668	010	85000	89436		
A-20345	010	85345	...		
A-20886	010	85030	89440		
A-20887	010	85005	89430		

APPLICATION GUIDE - TRUCKS, TRAILERS, AND BUSES









Year Año Année	Model Modelo Modèle	OEM #	Front		Rear	
			Fleetline	GasSLX	Fleetline	GasSLX

HENDRICKSON TRAILER SUSPENSION SYSTEMS(Cont'd.)

Additional O.E.M. Interchanges(Cont'd.)

Models with O.E.M. Number	OEM #	Fleetline	GasSLX	Fleetline	GasSLX
A-2230	010	85005	89430
A-2232	010	85005	89430
A-2240-1	010	85043	...
A-2471	010	85006	...
A-4089	010	83209	89414
A-4890	010	85712	...
A-6156	010	85301	...
B-21832	010	85323	89436
B-21936	010	85064	...
B-21994	010	85938	...
B-21995	010	85344	...
B-22715	010	85000	89436
B-23014	010	85738	...
B-23290	010	83150	...
B-23362	010	...	89437
B-25174	010	85029	...
B-26652	010	85000	89436
B-27058	010	83128	...
B-27747	010	85911	...
B-29432	010	85323	89436
B-29678	010	85911	...
B-29826	010	85338	...
B-33312	010	85338	...
B-33313	010	85338	...
NS500699	010	85005	89430
S-10348	010	85043	...
S-14583	010	85000	89436
S-1668	010	85000	89436
S-20001	010	83128	89436
S-20002	010	85000	89436
S-20126	010	85323	89436
S-20345	010	85345	...
S-20886	010	85030	89440
S-20887	010	85005	89430
S-20889	010	85323	89436
S-21292	010	85052	...
S-21553	010	85738	...
S-2160	010	85014	...
S-21699	010	87018	...
S-21832	010	85323	89436
S-21936	010	85064	...
S-21947	010	85052	...
S-2212	010	85029	...
S-2213	010	85010	...
S-2218	010	85030	89440
S-2230	010	85005	89430
S-22311	010	85045	...
S-22312	010	85939	...
S-2232	010	85005	89430
S-22345	010	85911	...
S-2240	010	85013	89414

APPLICATION GUIDE - TRUCKS, TRAILERS, AND BUSES

Year Año Année	Model Modelo Modèle	OEM #	Front		Rear	
						
						
			Fleetline	GasSLX	Fleetline	GasSLX

HENDRICKSON TRAILER SUSPENSION SYSTEMS(Cont'd.)

Additional O.E.M. Interchanges(Cont'd.)





	Models with O.E.M. Number	S-22715	010	85000	89436
		S-22862	010	85045	...
		S-23013	010	85000	89436
		S-23014	010	85738	...
		S-23290	010	83150	...
		S-23315	010	85029	...
		S-23316	010	85382	...
		S-23361	010	85911	...
		S-23362	010	...	89437
		S-23548	010	85079	...
		S-23649	010	85064	...
		S-23650	010	85052	...
		S-23651	010	85045	...
		S-23743	010	85938	...
		S-24023	010	85738	...
		S-24125	010	85323	89436
		S-24579	010	85939	...
		S-2471	010	85006	...
		S-25437	010	85337	...
		S-25515	010	85338	...
		S-26652	010	85000	89436
		S-29432	010	85323	89436
		S-29678	010	85911	...
		S-29826	010	85338	...
		S-33312	010	85338	...
		S-33313	010	85338	...
		S-33313L	010	85338	...
		S-4084	010	85005	89430
		S-4089	010	83209	89414
		S-4890	010	85712	...
	Models with O.E.M. Number						
	Heavy Duty	S-24088	010	85000	89436
	Standard	S-24088	010	83128	89436

HENDRICKSON TRUCK SUSPENSION SYSTEMS

Airtek - Series

	Airtek Front		010				
	Used on BlueBird	47170000456	010	85959
		58913-007	010	85959
		58913-007L	010	85959
		58913-008	010	85959
		58913-008L	010	85959
		58913-009	010	85959
		58913-009L	010	85959
		65992-003	010	85959
	Used on Freightliner / Western Star	471700006269	010	85932	89453
		58913-003	010	85932	89453
		58913-012	010	85932	89453
	Used on International	65992-001	010	85955
		65992-002	010	85955
		65992-006	010	85986

APPLICATION GUIDE - TRUCKS, TRAILERS, AND BUSES

Year Año Année	Model Modelo Modèle	OEM #	Front		Rear	
						
			Fleetline	GasSLX	Fleetline	GasSLX

HENDRICKSON TRUCK SUSPENSION SYSTEMS(Cont'd.)

Airtek - Series(Cont'd.)

	Used on Volvo / Mack	64838-001	OIO	85933	89454	
			OIO	85933	89454	
			OIO	85933	89454	
			OIO	85933	89454	
			OIO	85933	89454	
			OIO	85933	89454	

All American Series (FE & RE Models)

	Buses with Hendrickson 14,600 lb Capacity-Left Hand Drive Steertek Axle	58913-011	OIO	85959
--	---	-----------	-----	--------------	-----	--	-----	-----

Comfort Air - Series

	Conventional Hino Models with Single Axle Air Suspension	60670-013		OIO	83148	...
			OIO		83148	...
	Models with O.E.M. Number	471700131545		OIO	85006	...
			OIO		85006	...
			OIO		85006	...







Firemaax - Series

	Firemaax 240 Air Suspensions	60665-014		OIO	85962	...
			OIO		85961	...
			OIO		85967	...
			OIO		85072	...
			OIO		85962	...
	Firemaax 270 Air Suspensions	60665-015		OIO	85966	...
			OIO		85965	...
	Firemaax 480 Air Suspensions	60665-014		OIO	85962	...
			OIO		85961	...
			OIO		85967	...
			OIO		85072	...
			OIO		85962	...
	Firemaax 540 Air Suspensions	60665-015		OIO	85966	...
			OIO		85965	...
	Firemaax EX 242 Air Suspensions	60665-011		OIO	85967	...
			OIO		85072	...
	Firemaax EX 272 Air Suspensions	60665-015		OIO	85966	...
			OIO		85965	...
	Firemaax EX 482 Air Suspensions	60665-011		OIO	85967	...
			OIO		85072	...
	Firemaax EX 542 Air Suspensions	60665-015		OIO	85966	...
			OIO		85965	...

HA - Series

	HA - 180 (Used on all except Mack)	47902-13		OIO	83122	89406
			OIO		83122	89406
	HA - 200 (Used on all except Mack)	47902-13		OIO	83122	89406
			OIO		83122	89406
	HA - 230 (Used on all except Mack)	47902-13		OIO	83122	89406
			OIO		83122	89406

APPLICATION GUIDE - TRUCKS, TRAILERS, AND BUSES

Year Año Année	Model Modelo Modèle	OEM #	Front		Rear	
						
			Wrench	Fleetline 	GasSLX 	Wrench

HENDRICKSON TRUCK SUSPENSION SYSTEMS(Cont'd.)





HA - Series(Cont'd.)

	HA - 360 (Used on all except Mack)	47902-13	010	83122	89406
		47902-8	010	83122	89406
	HA - 400 (Used on all except Mack)	47902-13	010	83122	89406
		47902-8	010	83122	89406
	HA - 460 (Used on all except Mack)	47902-13	010	83122	89406
		47902-8	010	83122	89406
	HA Series Air Suspension (All Models used on Mack)	47902-19	010	83123	89405
		47902-9	010	83123	89405
	HA-360/400/460 Edge System High Torque Rise	60675-003	010	85976	...

HAS - Series

	HAS - 120L	60670-010	010	83149	...
	HAS - 150L	60670-003	010	83149	...
	HAS - 190	60675-003	010	85976	...
	HAS - 190 Standard	60670-005	010	83137	...
	HAS - 190L	60670-008	010	83123	89405
	HAS - 210	60675-003	010	85976	...
	HAS - 210 Standard	60670-005	010	83137	...
	HAS - 210L	60670-008	010	83123	89405
	HAS - 230	60675-003	010	85976	...
	HAS - 230 Standard	60670-005	010	83137	...
	HAS - 230L	60670-008	010	83123	89405
	HAS - 360	60675-003	010	85976	...
	HAS - 360 Standard	60670-005	010	83137	...
	HAS - 400	60675-003	010	85976	...
		60675-006	010	85909	...
	HAS - 400 Mack & Kenworth Air Suspensions Standard Standard Inboard Rear	47902-25	010	83125	...
		60670-005	010	83137	...
		60670-007	010	83144	...
	HAS - 400L	60670-008	010	83123	89405
	HAS - 402	60675-003	010	85976	...
		60675-006	010	85909	...
	HAS - 402 Standard Standard Inboard Rear	60670-005	010	83137	...
		60670-007	010	83144	...
	HAS - 402L	60670-008	010	83123	89405
	HAS - 40LH	60685-001	01-	85977	...
	HAS - 40LH Standard	60680-001	01-	83111	...
		60675-003	010	85976	...
	HAS - 460	60675-006	010	85909	...
		60670-005	010	83137	...
	HAS - 460 Standard Standard Inboard Rear	60670-007	010	83144	...
		60670-008	010	83123	89405
	HAS - 460L	60670-008L	010	83123	89405
		60670-008L	010	83123	89405
	Models with O.E.M. Number	60675-014	010	85978	...

APPLICATION GUIDE - TRUCKS, TRAILERS, AND BUSES

Year Año Année	Model Modelo Modèle	OEM #	Front		Rear	
						
			Fleetline	GasSLX	Fleetline	GasSLX

HENDRICKSON TRUCK SUSPENSION SYSTEMS(Cont'd.)

HAS - Series(Cont'd.)

Models with O.E.M. Number	60675-8Q		010	85976	...
---------------------------	----------	--	-----	-----	-----	--------------	-----

HN - Series

HN - 400 Models built between Mar/96 - Sept/97 Models built between Nov/88 - Feb/96	60680-003		01-	83112	...
	60670-002		010	83207	89407
HN - 402 Models built between Apr/96 - Dec/04	57241-003		01-	83112	...
	60680-003		01-	83112	...
HN - 460 Models built between Mar/96 - Sept/97 Models built between Nov/88 - Feb/96	57241-003		01-	83112	...
	60680-003		01-	83112	...
	60670-002		010	83207	89407
HN - 462 Models built between Apr/96 - Dec/04	57241-003		01-	83112	...
	60680-003		01-	83112	...
96 - 15 HN - 522	60680-003		01-	83112	...
HNT - 460	47902-18		010	85030	89440

HTB 400 LT - Series

HTB 400LT Rear Air Suspensions	60657-006		010	85102	...
	60657-010		010	85102	...
	60657-011		010	85102	...

Primaax - Series

230 Air Suspensions For International Models with 9" Ride Height Standard with 12 1/2" - 14 3/8" - 15 1/2" Ride Height Standard with 8 1/2" to 10" Ride Height	60657-003		010	85072	...
	60665-011		010	85967	...
	60657-003		010	85072	...
260 Air Suspensions Disc Brake Applications with 8 1/2" to 10" Ride Height Drum Brake Applications with 8 1/2" to 10" Ride Height	60665-015		010	85966	...
	60665-013		010	85965	...
460 Air Suspensions For International Models with 9" Ride Height Standard with 12 1/2" - 14 3/8" - 15 1/2" Ride Height Standard with 8 1/2" to 10" Ride Height	60657-003		010	85072	...
	60665-011		010	85967	...
	60657-003		010	85072	...
520 Air Suspensions Disc Brake Applications with 8 1/2" to 10" Ride Height Drum Brake Applications with 8 1/2" to 10" Ride Height	60665-015		010	85966	...
	60665-013		010	85965	...
690 Air Suspensions For International Models with 9" Ride Height Standard with 12 1/2" - 14 3/8" - 15 1/2" Ride Height Standard with 8 1/2" to 10" Ride Height	60657-003		010	85072	...
	60665-011		010	85967	...
	60657-003		010	85072	...
780 Air Suspensions Disc Brake Applications with 8 1/2" to 10" Ride Height Drum Brake Applications with 8 1/2" to 10" Ride Height	60665-015		010	85966	...
	60665-013		010	85965	...
EX 232 Air Suspensions Standard with 12 1/2" - 14 3/8" - 15 1/2" Ride Height Standard with 8 1/2" to 10" Ride Height	60665-011		010	85967	...
	60657-003		010	85072	...
EX 262 Air Suspensions Disc Brake Applications with 8 1/2" to 10" Ride Height Drum Brake Applications with 8 1/2" to 10" Ride Height	60665-015		010	85966	...
	60665-013		010	85965	...
EX 462 Air Suspensions Standard with 12 1/2" - 14 3/8" - 15 1/2" Ride Height	60665-011		010	85967	...

APPLICATION GUIDE - TRUCKS, TRAILERS, AND BUSES

Year Año Année	Model Modelo Modèle	OEM #	Front		Rear	
			Fleetline	GasSLX	Fleetline	GasSLX

HENDRICKSON TRUCK SUSPENSION SYSTEMS(Cont'd.)

Primaax - Series(Cont'd.)

	Standard with 8 1/2" to 10" Ride Height	60657-003		010	85072	...
	EX 522 Air Suspensions							
	Disc Brake Applications with 8 1/2" to 10" Ride Height	60665-015		010	85966	...
	Drum Brake Applications with 8 1/2" to 10" Ride Height	60665-013		010	85965	...
	EX 692 Air Suspensions							
	Standard with 12 1/2" - 14 3/8" - 15 1/2" Ride Height	60665-011		010	85967	...
	Standard with 8 1/2" to 10" Ride Height	60657-003		010	85072	...
	EX 782 Air Suspensions							
	Disc Brake Applications with 8 1/2" to 10" Ride Height	60665-015		010	85966	...
	Drum Brake Applications with 8 1/2" to 10" Ride Height	60665-013		010	85965	...
	Models with O.E.M. Number	60657-005		010	85087	...

Additional Applications

	Conventional Hino Models with Hendrickson Comfort Air Suspension	60670-020		010	83148	...
	HAS 400 / 460 Suspensions with O.E.M. Number	60675-005		010	85980	...
	Hendrickson Rear Air Suspension used on Conventional Hino Models (23,000 lb Capacity)	60670-018		010	83166	...
	HMX 400/460 Haulmax with 16.5" Saddle Height	60680-004		01-	83143	...
	HMX 400/460 Haulmax with 17.5" or 18.5" Saddle Height	60680-005		01-	83142	...
	HTS 210 For Spartan Chassis (Type C School Bus Applications)	60665-025		010	85036	...
	MaxAir / AL-405 Models	57241-006		01-	83111	...
	Parasteer Suspensions							
	Models with O.E.M. Number	59483-000	010	85919
		60665-005	010	85919
		60998-002	010	85919
	RT2 & RTE2 (400 / 520) Models Air Suspension (Note: For Ride Height of 10.41" to 12.27" with 52" & 54" Beams and 8.52" to 10.37" with 60" Beams.)	57324-6		010	85904	...

Additional O.E.M. Interchanges

	Models with O.E.M. Number	12738		010	83225	...
		47902-11		010	83207	89407
		47902-15		010	83137	...
		47902-20		010	85036	89405
		47902-21		010	85976	...
		47902-22		010	85916	...
		47902-24		010	83137	...
		47902-26		010	83144	...
		47902-27		010	83123	89405
		47902-28		010	85013	89414
		47902-29		010	83149	...
		47902-3		010	85005	89430
		503610C2		010	83207	89407
		5554596		010	85303	89422
		57241-001		01-	83111	...
		57241-002		01-	83109	...
		57241-004		01-	83110	...
		57324-1		010	85036	89405
		57324-11		010	85305	...
		57324-2		010	85976	...
		57324-3		010	85916	...
		57324-5		010	85903	...
		57905-1		010	85976	...

APPLICATION GUIDE - TRUCKS, TRAILERS, AND BUSES









Year Año Année	Model Modelo Modèle	OEM #	Front		Rear	
			Fleetline	GasSLX	Fleetline	GasSLX

HENDRICKSON TRUCK SUSPENSION SYSTEMS(Cont'd.)

Additional O.E.M. Interchanges(Cont'd.)

Models with O.E.M. Number	OEM #	Front	Rear	Front	Rear
58623-1	010	85978	...
59048-001	010	83148	...
59057-001	010	83137	...
59057-002	010	85036	89405
59305-1	010	85979	...
59851-1	010	85976	...
59852-1	01-	85977	...
59852-2	01-	85977	...
60657-007	010	85072	...
60665-003	010	83137	...
60665-004	010	85036	89405
60665-008	010	85978	...
60665-009	010	85904	...
60665-020	010	85919	...
60665-024	010	85903	...
60670-001	010	85036	89405
60670-001	010	83123	89405
60670-004	010	83123	89405
60670-006	010	83147	...
60670-009	010	85013	89414
60670-011	010	83148	...
60670-012	010	83168	...
60670-014	010	83166	...
60670-019	010	83166	...
60670-12	010	83168	...
60675-001	010	85978	...
60675-002	010	85979	...
60680-002	01-	83109	...
60680-009	01-	85083	...
60680-012	01-	85083	...
654890	010	83207	89407
654891	010	83149	...
654894	010	83123	89405
654895	010	83137	...
654896	010	83147	...
654897	010	83144	...
654897	010	83144	...
654898	010	83123	89405
654899	010	85013	89414
654900	010	83149	...
654903	01-	83111	...
654904	01-	83109	...
654905	01-	83112	...
659000	010	83148	...
659004	010	83123	89405
659048	01-	83143	...
659049	01-	83142	...
659155	010	83147	...
659202	010	83148	...
659292	010	83148	...
665816	010	85072	...

APPLICATION GUIDE - TRUCKS, TRAILERS, AND BUSES

Year Año Année	Model Modelo Modèle	OEM #	Front		Rear	
						
						
			Fleetline	GasSLX	Fleetline	GasSLX

HENDRICKSON TRUCK SUSPENSION SYSTEMS(Cont'd.)

Additional O.E.M. Interchanges(Cont'd.)

Year	Model	OEM #	Front	Rear	Front	Rear
	Models with O.E.M. Number	665892	OIO	85072
		671006	OIO	85036 89405
		671007	OIO	83137
		671009	OIO	85919
		671030	OIO	85083
		671063	OIO	85083
		671105	OIO	85072
		671603	OIO	85919
		671606	85955	...	OIO	...
		671611	85955	...	OIO	...
		671704	OIO	85904
		671764	OIO	85967
		671792	OIO	85965
		671793	OIO	85966
		671798	OIO	85962
		672009	OIO	85903
		680091	OIO	85303 89422
		680600	OIO	85305
		70018	OIO	85303 89422
		70021	OIO	85303 89422
		70088	OIO	85307
		98583-005	OIO	83168
		98583-006	OIO	83148
		98583-016	OIO	83147
		98583-032	OIO	85072
		AE76164-3	OIO	85307
		AE76164-4	OIO	83225
		BE76164-2	OIO	85303 89422
		BE76164-3	OIO	85307
		BE76164-4	OIO	83225

HIGHWAY PRODUCT

	Transit Bus with Air Suspension	OIO	83203	89436
	Transit Bus with Leaf Spring Suspension		83203	...	OIO	83203 89436
		A1-6-134		OIO	83207 89407
		A1-6-135	OIO	83203	89436

HINO

145 Series

05 - 10	Models with O.E.M. Number	48500-3710	OIO	83126	89430
		485003710A	OIO	83126	89430
		S4850-03710	OIO	83126	89430
		48530-3280		OIO	G63440
		S4853-03280		OIO	G63440





155 Series

13 - 17	Models with O.E.M. Number	48511-37320	-IO	83518
		48511-80162	-IO	83518

165 Series

05 - 10	Models with O.E.M. Number	48500-3710	OIO	83126	89430
		485003710A	OIO	83126	89430
		S4850-03710	OIO	83126	89430

APPLICATION GUIDE - TRUCKS, TRAILERS, AND BUSES

Year Año Année	Model Modelo Modèle	OEM #	Front				Rear			
										
				Fleetline	GasSLX		Fleetline	GasSLX		

HINO(Cont'd.)

165 Series(Cont'd.)

05 - 10	Models with O.E.M. Number	48530-3280		010	G63440	...
		S4853-03280		010	G63440	...

185 Series

05 - 10	Models with O.E.M. Number	48500-3710	010	83126	89430	
		485003710A	010	83126	89430	
		48500-3720	010	83140
		S4850-03710	010	83126	89430	
		S4850-03720	010	83140
		48530-3280		010	G63440	...
		S4853-03280		010	G63440	...

195 Series

13 - 17	Models with O.E.M. Number	48511-37320	-10	83518
		48511-80162	-10	83518
		48531-37361		010	83519	...
		48531-37362		010	83519	...

238 Series

05 - 14	Models with O.E.M. Number	48500-3720	010	83140
		S4850-03720	010	83140

258 Series

08 - 17	258 LP Car Carrier Models with Hendrickson Rear Air Suspension	48530E0100		010	83166	...
		60670-014		010	83166	...
05 - 14	Models with O.E.M. Number	48500-3720	010	83140
		S4850-03720	010	83140

268, 268A Series

	Models with Hendrickson Rear Air Suspension (Shock stamping #)	60670-012		010	83168	...
05 - 14	Models with O.E.M. Number	48500-3720	010	83140
		S4850-03720	010	83140

308 Series

07 - 10	Models with O.E.M. Number	48500-3720	010	83140
		S4850-03720	010	83140

338 Series

05 - 14	Models with O.E.M. Number	48500-3720	010	83140
		S4850-03720	010	83140









358 Series

07 - 14	Models with O.E.M. Number	48500-3720	010	83140
		S4850-03720	010	83140

FA, FB Series

89 - 04	FA, FB Models Trucks with: Front Shock with O.E.M. Number	48500-1950	-10	G63610	
		48500-2750	-10	G63610	
		66639	-10	G63610	
		S4850-01950	-10	G63610	
		S4850-02750	-10	G63610	
		Rear Shock with O.E.M. Number	34802		010	83216	...
			48530-1910		010	83216	...
			48530-2510		010	83216	...
			S4853-01910		010	83216	...
			S4853-02510		010	83216	...
			89 - 96	FA14, FB14	48500-1950	-10	G63610	...	

APPLICATION GUIDE - TRUCKS, TRAILERS, AND BUSES

Year Año Année	Model Modelo Modèle	OEM #	Front		Rear	
						
						
			Fleetline	GasSLX	Fleetline	GasSLX

HINO(Cont'd.)

FA, FB Series(Cont'd.)

89 - 96	FA14, FB14	48530-1910		010	83216	...
93 - 97	FA1415 (FA15), FB1715 (FB15)	48500-1950	-10	G63610
		48530-1910		010	83216	...
92 - 96	FA15, FB15	48500-1950	-10	G63610
		48530-1910		010	83216	...
98	FA1517, FA1817, FB1817	010	G63419	...
		48530-2510		010	83216	...

FD Series

98 - 03	FD Models Trucks with O.E.M. Number	48500-1801	010	83216
		48530-1880		010	83362	...
86 - 87	FD16	48500-1801	010	83216
		48530-1880		010	83362	...
88 - 91	FD17	48500-1801	010	83216
		48530-1880		010	83362	...
92	FD20	48500-1801	010	83216
93 - 97	FD2218, FD2218LD (FD5H). FE5H, FF5H	48500-1801	010	83216
		48530-1880		010	83362	...
98	FD2220, FD2220 Lo Pro	48500-1801	010	83216

FE Series

86 - 87	FE16	48500-1801	010	83216
		48530-1890		010	83104	...
84 - 91	FE17, FE19	48530-1900		010	83104	...
92	FE20	48530-1900		010	83104	...
93 - 97	FE2618 (FE5H)	48530-1900		010	83104	...
98	FE2620	48530-1880		010	83362	...
98 - 04	FE Models Trucks with: Front Shock with O.E.M. Number Rear Shock with O.E.M. Number	48500-1941	010	83141
		S4850-01941	010	83141
		48530-1900		010	83104	...
		S4853-01900		010	83104	...
		48530-3280		010	G63440	...
		S4853-03280		010	G63440	...

FF Series

98 - 03	FF Models Trucks with O.E.M. Number	48500-1941	010	83141
		48530-1900		010	83104	...
84 - 91	FF17, FF19	48530-1900		010	83104	...
92	FF20, FF23	48530-1900		010	83104	...
93 - 97	FF3018 (FF5H)	48530-1900		010	83104	...
93 - 97	FF3020 (FF4H)	48530-1900		010	83104	...
98	FF3320	48530-1880		010	83362	...
87 - 88	FFC1	48530-1900		010	83104	...

FG Series

84 - 85	FG19, FG22	48530-1900		010	83104	...
---------	------------	------------	--	-----	-----	-----	-------	-----

GC Series

90 - 91	GC17	48500-1801	010	83216
		48530-2050		010	83217	...
92	GC20	48500-1801	010	83216
		48530-2050		010	83217	...

SG Series

98 - 03	SG Models Trucks with O.E.M. Number	48500-1941	010	83141
---------	-------------------------------------	------------	-----	-------	-----	--	-----	-----

APPLICATION GUIDE - TRUCKS, TRAILERS, AND BUSES

Year Año Année	Model Modelo Modèle	OEM #	Front				Rear			
							Fleetline		GasSLX	
							○ ○	83141	...	○ ○

HINO(Cont'd.)

SG Series(Cont'd.)

98 - 03	SG Models Trucks with O.E.M. Number	S4850-01941	○ ○	83141	...	○ ○	83141	...
86 - 91	SG19	48500-1941	○ ○	83141	...	○ ○	83141	...
92	SG20	48500-1941	○ ○	83141	...	○ ○	83141	...
86	SG22 Straight Truck	48500-1941	○ ○	83141	...	○ ○	83141	...
86	SG221 Tractor	48500-1941	○ ○	83141	...	○ ○	83141	...
87 - 92	SG23 Straight Truck	48500-1941	○ ○	83141	...	○ ○	83141	...
87 - 92	SG231 Tractor	48500-1941	○ ○	83141	...	○ ○	83141	...
93 - 97	SG3320 (SG4H)	48500-1941	○ ○	83141	...	○ ○	83141	...
93 - 97	SG3323 (SG1H) Straight Truck	48500-1941	○ ○	83141	...	○ ○	83141	...
93 - 97	SG5523 (SG1HD) Tractor	48500-1941	○ ○	83141	...	○ ○	83141	...

Additional Applications

	Conventional Hino Models with Hendrickson Comfort Air Suspension	60670-020		○ ○	83148	...
	Conventional Hino Models with Hendrickson Comfort Air Suspension (23,000 lb Capacity)	60670-018		○ ○	83166	...
	Conventional Hino Models with Hendrickson Comfort Air Suspension (19,000 lb & 21,000 lb Capacity)	60670-013		○ ○	83148	...
	Conventional Hino Models with Hendrickson Rear Air Suspension	60670-014		○ ○	83166	...
		60670-019		○ ○	83166	...
	Models with O.E.M. Number	48500-1800	○ ○	83216
		48500-1940	○ ○	83141
		48530-1120		○ ○	83104	...
		48530-1460		○ ○	83215	...
		48530-1620		○ ○	83104	...
		48530-1770		○ ○	83215	...

HOBBS TRAILERS

	Models with O.E.M. Number	680117		○ ○	85300	89419
--	---------------------------	--------	--	-----	-----	-----	-------	-------

HOLIDAY RAMBLER

99 - 03	Admiral, Endeavor Gas and Vacationer Models with F53 Motorhome Chassis (16,000 lb to 22,000 lb GVW)	○ ○	83209	...	○ ○	83122	...
90 - 97	Admiral, Endeavor Gas and Vacationer Models with F53 Motorhome Chassis (7.5 L, Gas V8)	○ ○	83209	...	○ ○	85097	...
99 - 03	Atlantis Models with Ford E450 Chassis	- ○	83177	...	- ○	83178	...
	Models with Mor-Ryde Suspension	U0109-007		○ ○	663183	...
	Models with Neway Trailer Air Suspension	90044794		○ ○	83127	...
95 - 99	MotorHomes with Freightliner XC Chassis (22,000 to 26,000 lb GVW)	○ ○	83160	...	○ ○	85029	...

HOLLAND - BINKLEY

	Air Plus Integrated Air Susp. with ProPar Parallel Spindle Axles	6898		○ ○	83125	...
	Holland ProPar NT2 Air Suspension	680298		○ ○	85321	...

HOLLAND (SEE NEWAY)

Refer to SAF Holland Section for application information								
--	--	--	--	--	--	--	--	--









HUTCHENS SUSPENSION

	Models with O.E.M. Number	9423-00		○ ○	83203	89436
--	---------------------------	---------	--	-----	-----	-----	-------	-------

HYSTER

	Straddle Carrier	650150		83217	...	○ ○	83217	...
--	------------------	--------	--	-------	-----	-----	-------	-----

APPLICATION GUIDE - TRUCKS, TRAILERS, AND BUSES

Year Año Année	Model Modelo Modèle	OEM #	Front		Rear	
						
						
			Fleetline	GasSLX	Fleetline	GasSLX

HYSTER(Cont'd.)

	Straddle Carrier	73516		83217	...	010	83217	...
--	------------------	-------	--	-------	-----	-----	-------	-----

IC CORPORATION

AE Series School Bus

	AE Model School Buses with O.E.M. Number	3902993C2	010	83135
		3902993C3	010	83135

BE Series School Bus

- 12	BE200 Model School Buses with 7000 lb Front Axle	3605735C1	010	83156
		3605735C2	010	83156

CE Series School Bus

06 - 17	CE Model School Buses (71 Capacity) with 9,000 to 10,000 lb Front Suspension	3578105C1	010	83163
		3578105C2	010	83163
		6127088C1	010	83163
		OE13402S	010	83163
10 - 15	CE Model School Buses with 20,000 lb International IROS Air Suspension	3578858C2		010	85926	...
16 - 17	CE Model School Buses with 20,000 lb Rear Air Suspension	3601600C3		010	85082	...
05 - 13	CE Model School Buses with 22,000 lb Rear Spring Suspension	501906C91		-10	83317	...
		501906C92		-10	83317	...
		OE13424S		-10	83317	...
13 - 16	CE Model School Buses with 6,000 to 8,000 lb Front Axles	3533356C3	010	83169

RE Series School Bus

	RE Model School Buses with 12,000 to 14,000 lb Front Axles	2200327C1	-10	85332
	RE Model School Buses with Hendrickson AirTek Front Suspension	65992-006	010	85986
	RE Model School Buses with O.E.M. Number	3604282C1	-10	85351
		472412C91	-1-	83456	89447	

INGERSOLL AXLES





	Ingersoll part number	653511-01		010	85323	89436
		653511-02		010	85938	...
		653511-03		010	85045	...
		653511-04		010	85052	...

INTERNATIONAL (NAVISTAR)

A, B, AC and BC Conventional

	A-140 (4 x 4) Models	010	83216	...
	A-160, B-160, AC-160, BC-160 Models	308649C91		010	83216	...
		308650C91		010	83216	...
		453567C91		010	83216	...
	A-170, B-170, AC-170, BC-170, A-180, B-180, AC-180, BC-180 Models	308646C91	010	85012	89413	
		308649C91		010	83216	...
		308650C91		010	83216	...
		453567C91		010	83216	...
	AB-140 Models		G63306	...	010	G63306	...
	AC-170 & BC-170 (4 x 4) Models	010	83216	...
	AC-180 & BC-180 (4 x 4) Models	010	83216	...
	ACF-170 & BCF-170 Models	308646C91		010	85012	89413
	BCF-195-D Models	010	83225	...
	C-150 Models	010	G63306

APPLICATION GUIDE - TRUCKS, TRAILERS, AND BUSES

Year Año Année	Model Modelo Modèle	OEM #	Front		Rear	
						
			Fleetline	GasSLX	Fleetline	GasSLX

INTERNATIONAL (NAVISTAR)(Cont'd.)

A, B, AC and BC Conventional(Cont'd.)

	C-150 Models	308649C91 308668C91 453556C91 453567C91		010	83216	...
				010	85012	89413
				010	85012	89413
				010	83216	...

BE Series School Bus

- 12	BE200 Model School Bus Chassis with 7000 lb Front Axle	3605735C1 3605735C2 3609400C1 3609400C2	010	83156	...	010
			010	83156	...	010
				-10	83317	...
				-10	83317	...





Binder

	Binder	453556C91 453571C91 467983C91 467985C91 471201C91	010	85012	89413	010
				010	83216	...
			010	85012	89413	
			010	85012	89413	
			010	85012	89413	
	S Models Binder	472367C91	-1-	83318

Cargostar

	CO-1600, CO-1610A & B, CO-1630A & B, CO-1700, CO-1710A & B, CO-1730A & B, CO-1750, CO-1750A & B, CO-1800, CO-1810A & B, CO-1830A & B, CO-1850, and CO-1850A & B	206620R91 206621R92 294334C91 3085640C92 308646C91 308649C91 308650C92 360444C91 453564C91 453567C91 453570C91 467983C91 467984C91		010	83216	...
				010	83216	...
				010	83216	...
				010	83216	...
				010	85012	89413
				010	83216	...
				010	83216	...
				010	85012	89413
				010	83216	...
				010	83216	...
				010	85012	89413
				010	83216	...
				010	83216	...
	CO-1610A & B, CO-1630A & B, CO-1710A & B, CO-1730A & B, CO-1750A & B, CO-1810A & B, CO-1830A & B, COF-1810A & B - Exc. with 9000, 10800, or 12000 lb Front Axle	453572C91	010	83309	89446	
	CO-1610A & B, CO-1630A & B, CO-1710A & B, CO-1730A & B, CO-1750A & B, CO-1810A & B, CO-1830A & B, COF-1810A & B - With 9000, 10800, or 12000 lb Front Axle	873619C92 873619C93	010	83314
	CO-190, VCO-190, CO-200, DCO-200, VCO-200, CO-220, VCO-220 With Air Ride Suspension After Chassis No G-387453	350425C1 462557C91		010	85300	89419
	CO-190, VCO-190, CO-200, DCO-200, VCO-200, CO-220, VCO-220 With Air Ride Suspension before Chassis No G-387453	350426C91		010	85734	...
	CO-190, COF-190, VCO-190, VCOF-190 & CO-200, DCO-200, VCO-200 & CO-220, VCO-220 & VCO-190 (4 man cab)	204994R91 210534R92 288920C91 288921R92 308648C91 452566C91	010	83225
			010	83225
			010	83225
			010	83225
			010	83225
			010	83225

APPLICATION GUIDE - TRUCKS, TRAILERS, AND BUSES

Year Año Année	Model Modelo Modèle	OEM #	Front		Rear	
						
			Fleetline	GasSLX	Fleetline	GasSLX

INTERNATIONAL (NAVISTAR)(Cont'd.)

Cargostar(Cont'd.)

CO-190, COF-190, VCO-190, VCOF-190 & CO-200, DCO-200, VCO-200 & CO-220, VCO-220 & VCO-190 (4 man cab)	453561C91	010	83225
	453562C91	010	83225
	453565C91	010	83225
	453569C91	010	83225
	467371C91	010	83225
	467372C91	010	83225
CO-1910A & B, CO-1950A & B, COF-1910A& B, COF-1950A & B	453572C91	010	83309	89446	
	873619C92	010	83314
CO-1950 , COF-1950 & COT-1950	204994R91	010	83225
	288920C91	010	83225
	288921C91	010	83225
	308648C91	010	83225
	453561C91	010	83225
	453565C91	010	83225
	453566C91	010	83225
	453569C91	010	83225
	467371C91	010	83225
	467372C91	010	83225
CO-1950 with Air Ride Suspension After Chassis No. G-387453	350425C1		010	85300	89419
	462557C91		010	85300	89419
CO-1950 with Air Ride Suspension Before Chassis No. G-387453	350426C1		010	85734	...

CE Series School Bus

06 - 17	CE Model School Buses (71 Capacity) with 9,000 to 10,000 lb Front Suspension	3578105C1	010	83163
		3578105C2	010	83163
		6127088C1	010	83163
		OE13402S	010	83163
10 - 15	CE Model School Buses with 20,000 lb International IROS Air Suspension	3578858C2		010	85926	...
05 - 13	CE Model School Buses with 22,000 lb Rear Spring Suspension	501906C92		-10	83317	...
		OE13424S		-10	83317	...
13 - 16	CE Model School Buses with 6,000 to 8,000 lb Front Axles	3533356C3	010	83169





Co-Transtar and Transtar II

7070B, F-7070B, CO-7070B & COF-7070B Models	426744R91	010	85303	89422	
	426744R92	010	85303	89422	
	453576C91	010	85303	89422	
	453576C92	010	85303	89422	
	477132C1	010	85303	89422	
CO-4010, COF-4010, COT-4010, COT-4010D, CO-4050, COF-4050, COT-4050, CO-4040A & B, CO-4070D, COF-4070B, COF-4070D, COT-4070D, COF-4077, COF-4077A, COF-4080D, CO-4090A, COF-4090A	426744R91	010	85303	89422	
	426744R92	010	85303	89422	
	453576C91	010	85303	89422	
	453576C92	010	85303	89422	
CO-4070A, COF-4070A, COF-4090A with Rear Suspension	462557C91		010	85300	89419

CXT Series

CXT Models with 9,000 to 10,000 lb Front Suspension	3606770C1	010	83163
	3606770C2	010	83163

APPLICATION GUIDE - TRUCKS, TRAILERS, AND BUSES

Year Año Année	Model Modelo Modèle	OEM #	Front		Rear	
			 Fleetline	 GasSLX	 Fleetline	 GasSLX

INTERNATIONAL (NAVISTAR)(Cont'd.)

DuraStar - 1000 Series(Cont'd.)

	1300 Models	56110-T8123	- O	G63432
		56110-T8129	- O	G63432
		66400	- O	G63432





DuraStar - 4300, 4400 Series

13	Low-Profile models with O.E.M. Number	1660846C92		O O	83101	...	
02 - 15	Models with 12,000 lb Front axle	3533357C1	O O	85957	
		3533357C2	O O	85957	
		3533357C3	O O	85957	
- 15	Models with 20,000 lb International IROS Air Suspension	3578858C1		O O	85926	...	
		3578858C2		O O	85926	...	
02 - 13	Models with 22,000 lb Rear Spring Suspension	501906C91		- O	83317	...	
		501906C92		- O	83317	...	
- 11	Models with 40,000 lb Rear Air Suspension	3549099C2		O O	85923	89458	
02 - 12	Models with 6,000 to 8,000 lb Front Suspension	3533356C1	O O	83135	
		3533356C2	O O	83135	
13 - 16	Models with 6,000 to 8,000 lb Front Suspension	3533356C3	O O	83169	
- 15	Models with 9,000 to 10,000 lb Front Suspension	3578105C2	O O	83163	
16 - 17	Models with 9,000 to 10,000 lb Front Suspension	6127088C1	O O	83163	
- 17	Models with Hendrickson HAS - 230 or 460 Rear Air Suspension	60675-003		O O	85976	...	
		Models with International IROS Air Suspension	3553628C1		O O	85927	...
		3553628C2		O O	85927	...	
		3553628C3		O O	85927	...	
02 - 12	School Bus models with 6,000 to 8,000 lb Front Suspension	3533356C1	O O	83135	
		3533356C2	O O	83135	

F & S Series

	1600, 1700, 1800, 1900, 2100 Models	3000070C91	- -	83456	89447	
		453576C92	O O	85303	89422	
	1600, 1700, 1800, 1900, 2100 Models with International Air Suspension	1675455C1		O O	85003	89411
		1690035C1		O O	85003	89411
		2018987C1		O O	85003	89411
		2018987C2		O O	85003	89411
		501553C91		O O	85003	89411
	1600, 1700, 1800, 1900, 2100 Models with Neway ARD-234 Air Suspension	537524C91		O O	83123	89405
	1624, 1654, 1724, 1754, 1824, 1854, 1924, F1924, 1925, 1954, F1954, 1955, 2124, 2125, F2125, 2154, 2155 Models Exc. with Rear Axle Codes 14029, 14030, 14187	501905C91		- O	83301	...
		501906C91		- O	83317	...
	1624, 1654, 1724, 1754, 1824, 1854, 1924, F1924, 1925, 1954, F1954, 1955, 2124, 2125, F2125, 2154, 2155 Models with 5000, 6000 or 7500 lb Front Axle	472367C91	- -	83318
	1624, 1654, 1724, 1754, 1824, 1854, 1924, F1924, 1925, 1954, F1954, 1955, 2124, 2125, F2125, 2154, 2155 Models with Rear Axle Codes 14029, 14030, 14187	501905C91		- O	83301	...
	1624, 1654, 1724, 1754, 1824, 1854, 1924, F1924, 1925, 1954, F1954, 1955, 2124, 2125, F2125, 2154, 2155, 2275, F2275, 2524, F2524, 2554, F2554, 2574, F2574, 2575, F2575, F2624, F2654, F2674 Models with 9000, 10800 or 12000 lb Front Axle	472411C91	- -	83456	89447	
		472412C91	- -	83456	89447	
		586724C91	- -	83456	89447	
	1924, 1954 (6 x 6) Models	472367C91	- -	83318
		472414C91	- -	83318

APPLICATION GUIDE - TRUCKS, TRAILERS, AND BUSES

Year Año Année	Model Modelo Modèle	OEM #	Front		Rear	
						
			Fleetline	GasSLX	Fleetline	GasSLX

INTERNATIONAL (NAVISTAR)(Cont'd.)

F & S Series(Cont'd.)

2275, F2275, 2524, F2524, 2554, F2554, 2574, F2574, 2575, F2575, F2624, F2654, F2674 Models with International Corporate Air Suspension	1675455C1	010	85003	89411
	1690035C1	010	85003	89411
	2018987C1	010	85003	89411
	2018987C2	010	85003	89411
	501553C91	010	85003	89411
2275, F2275, 2524, F2524, 2554, F2554, 2574, F2574, 2575, F2575, F2624, F2654, F2674 Models with Neway ARD-125/244 Air Suspension	790335C91	010	83209	89414
2275, F2275, 2524, F2524, 2554, F2554, 2574, F2574, 2575, F2575, F2624, F2654, F2674 Models with Neway ARD-234 Air Suspension	537524C91	010	83123	89405
2275, F2275, 2524, F2524, 2554, F2554, 2574, F2574, 2575, F2575, F2624, F2654, F2674 Models with Ridwell Rear Suspension	534464C1	010	85734	...

Firetruck

CO-8190	204994R91	010	83225
	308648C91	010	83225
	453561C91	010	83225
	453565C91	010	83225
	467371C91	010	83225
Models with O.E.M. Number	210919R91	010	85307	...





Fleetstar - Conventional

1900, F-1900, T-1900, 1950, F-1950, T-1950, 2000, 2000D, F-2000D & T-2000D Models	210535R91	010	83225
	453568C91	010	83225
	467372C91	010	83225
1910A, F-1910A, 2010A, F-2010A, 2050A, F-2050A, 2070A, F-2070A, 2110A & 2150A Models	206621R92	010	83216
	308650C92	010	83216
	453570C91	010	83216
	467984C91	010	83216
2000D, 2010A, 2050A, 2070A, 2110A, 2150A with Air Ride Suspension After Chassis No G-387453	350425C1	010	85300	89419
	462557C91	010	85300	89419
2000D, 2010A, 2050A, 2070A, 2110A, 2150A with Air Ride Suspension Before Chassis No G-387453	350426C1	010	85734	...
F-2010A, F-2050A, F-2000D with Air Ride Suspension	350425C1	010	85300	89419
	462557C91	010	85300	89419
R-185, R-190, RD-190, R-200, RD-200, RF-200, RDF-200, R-220, RD-220, R210 & RF-210	210533R91	010	83225
	210534R92	010	83225
	210535R91	010	83225
	210536R91	010	83225
	210537R91	010	83225
	210538R91	010	83225
	453562C91	010	83225
	453568C91	010	83225
	467371C91	010	83225
	467372C91	010	83225

Loadstar - Conventional

1600, 1600 (4x4), 1610, 1610 (4x4), 1610FC, 1700, 1700 (4x4), 1710, 1710 (4x4), F-1700, 1750, 1800, 1810, F-1800, F-1800-D, 1850, F-1850, 1890 & 1890-D with 9000, 10800 or 12000 lb Front Axle	329316C92	010	85012	89413
	360444C91	010	85012	89413

APPLICATION GUIDE - TRUCKS, TRAILERS, AND BUSES

Year Año Année	Model Modelo Modèle	OEM #	Front		Rear	
			 Fleetline	 GasSLX	 Fleetline	 GasSLX

INTERNATIONAL (NAVISTAR)(Cont'd.)





Loadstar - Conventional(Cont'd.)

1600, 1600 (4x4), 1610, 1610 (4x4), 1610FC, 1700, 1700 (4x4), 1710, 1710 (4x4), F-1700, 1750, 1800, 1810, F-1800, F-1800-D, 1850, F-1850, 1890 & 1890-D with 9000, 10800 or 12000 lb Front Axle	453564C91	010	85012	89413	
	467983C91	010	85012	89413	
	471201C91	010	85012	89413	
1600, 1600 (4x4), 1610, 1610 (4x4), 1610FC, 1700, 1700 (4x4), 1710, 1710 (4x4), F-1700, 1750, 1800, 1810, F-1800, F-1800-D, 1850, F-1850, 1890 & 1890-D with Axle Codes 02089, 02091	206620R91	010	83216
	308649C91	010	83216
	453567C91	010	83216
1600, 1600 (4x4), 1610, 1610 (4x4), 1700, 1700 (4x4), 1710, 1710 (4x4), 1750, 1800, 1810, 1850, 1890 & 1890-D Models	206620R91		010	83216	...
	206621R91		010	83216	...
	308649C91		010	83216	...
	308650C92		010	83216	...
	329316C92		010	85012	89413
	360444C91		010	85012	89413
	383379C91		010	83308	...
	453564C91		010	85012	89413
	453567C91		010	83216	...
	453570C91		010	83216	...
	453575C91		010	83308	...
	467983C91		010	85012	89413
	467984C91		010	83216	...
	471203C91		010	83308	...
474002C91		010	83308	...	
873622C91		010	83308	...	
1600, 1600 (4x4), 1610, 1610 (4x4), 1700, 1700 (4x4), 1710, 1710 (4x4), F-1700, 1750, 1800, 1810, F-1800, F-1800-D, 1850, F-1850, 1890 & 1890-D Exc. Axle Codes 02054, 02057, 02059, 02089, 02091, 02098, 02101, 02109, 02139, 02208, 02218, 02228, 02309, 0232	308668C92	010	85012	89413	
	453556C91	010	85012	89413	
	467985C91	010	85012	89413	
	874695R91	010	85012	89413	
	874695R92	010	85012	89413	
1600, 1610FC, 1700, 1700 (4x4), 1800, 1890, 1890D Models	384435C91		010	83216	...
	453571C91		010	83216	...
	462753C91		010	83216	...
1700, 1750, 1800, 1850 Models with Air Ride Suspension	462557C91		010	85300	89419
M1600, M1700, M1800, M1900, M2100 Models	453576C92	010	85303	89422	

LoneStar - Series

09 - 15	All models with 40,000 lb Rear Air Suspension	3620395C1		010	85931	89458
09 - 15	Day Cab models with 14,600 lb Parabolic Taperleaf Front Spring	3813341C1	010	85963
		3813341C2	010	85963
		3813341C3	010	85963
08 - 10	Models with 12,000 lb Mono-leaf Front Spring	3819277C1	010	85969
		3819279C1	010	85969
12 - 15	Models with 12,350 lb Front Mono Leaf Spring Suspension	3813341C2	010	85963
		3813341C3	010	85963
- 16	Models with Hendrickson HAS - 230 or 460 Rear Air Suspension	3514952C1		010	85976	...
		60675-003		010	85976	...

APPLICATION GUIDE - TRUCKS, TRAILERS, AND BUSES

Year Año Année	Model Modelo Modèle	OEM #	Front		Rear	
						
			Fleetline	GasSLX	Fleetline	GasSLX

INTERNATIONAL (NAVISTAR)(Cont'd.)

LoneStar - Series(Cont'd.)

- 16	Models with Hendrickson HAS - 230 or 460 Rear Air Suspension	H60675-003		010	85976	...
12 - 16	Models with International 40,000 lb Rear Air Suspension (52" Spacing- Heavy Duty Rear)	3688614C1		010	85923	89458
		3688616C1		010	85923	89458
13 -	Models with O.E.M. Number	3810581C3	010	85995
		3810581C4	010	85995
09 - 15	Sleeper Cab models with 14,000 lb Parabolic Taperleaf Front Spring	3813340C1	010	85964
		3813340C2	010	85964
		3813340C3	010	85964





Metro & Multi-Shop Series

	AM and AMC-160, AMC-164	308649C91	010	83216
		453567C91	010	83216
	M1600, M1700, M1800, M1900, M2100 Models	453576C92	010	85303	89422	
	M1600, M1700, M1800, M1900, M2100 Models - Exc. with Rear Axle Codes 14029, 14030, 14187	501905C91		-10	83301	...
		501906C91		-10	83317	...
	M1600, M1700, M1800, M1900, M2100 Models with 5000, 6000 or 7500 lb Front Axle	472367C91	-1-	83318
	M1600, M1700, M1800, M1900, M2100 Models with 9000, 10800 or 12000 Front Axle	472411C91	-1-	83456	89447	
	M1600, M1700, M1800, M1900, M2100 Models with Front Axle Codes 02109, 02118, 02309, 02127, 02139, 02329, 02339	472412C91	-1-	83456	89447	
		586724C91	-1-	83456	89447	
	M1600, MC1600, M1700 & MC1700	206620R91		010	83216	...
		308649C91		010	83216	...
		308668C91	010	85012	89413	
		308669C91	010	85012	89413	
		453556C91	010	85012	89413	
		453597C91		010	83216	...
		874695R91	010	85012	89413	
		874696R91	010	85012	89413	
	MA1200, M1400, M1500, MA1500	287318C91		G63306	...	010	G63306	...
		308649C91		010	83216	...
		308669C91		010	85012	89413
		453531C91		010	G63306	...
		453556C91		010	85012	89413
		453557C91		010	G63306	...
		453567C91		010	83216	...
		467980C91		G63306	...	010	G63306	...
66 - 72	Metro Models M1200 - Exc. Frame Code 01000.0962	010	G63299
66 - 72	Metro Models M1200 with 14016 Reg. Rear Springs & with 14020 Rear Axle Code		G63306	...	010	G63306	...
66 - 72	Metro Models M1200 with Axle Code 0208 & Frame Code 01000.0962		G63306	...	010	G63306	...
66 - 72	Metro Models M1200 with Code 03204 Aux. Springs	010	G63299	...
66 - 72	Metro Models M700, 800, 900-U, 1000, 1100,		G63306	...	010	G63306	...
73 - 75	Multi-Stop Models MS-1210 & 1510	010	G63306	...

Paystar - 5000 Series

	5010, F-5010, F-5050, F-5050SF, 5070, F-5070, F-5070SF Models	426744R91	010	85303	89422	
		426744R92	010	85303	89422	
		453576C91	010	85303	89422	

APPLICATION GUIDE - TRUCKS, TRAILERS, AND BUSES

Year Año Année	Model Modelo Modèle	OEM #	Front		Rear	
			 Fleetline	 GasSLX	 Fleetline	 GasSLX

INTERNATIONAL (NAVISTAR)(Cont'd.)









Paystar - 5000 Series(Cont'd.)

	5010, F-5010, F-5050, F-5050SF, 5070, F-5070, F-5070SF Models	453576C92	010	85303	89422	
		477132C1	010	85303	89422	
- 12	5600i Models with 16,000 lb Front axle	1667520C1	010	85058	89431	
		4070336C1	010	85058	89431	
04 - 12	5900 SB Models with 18,000 lb Front axle	1667520C1	010	85058	89431	
04 - 15	5900 SB Models with 46,000 lb Hendrickson Rear Air Suspension	3626571C1		010	85072	...
		H60657-003		010	85072	...
- 15	5900 SB Models with Hendrickson Primaax 230, 460 and 690 Air Suspension (8-1/2" to 10" Ride Height)	60657-003		010	85072	...
- 15	5900 SB Models with Hendrickson Primaax EX 232, 462 and 692 Air Suspension (8-1/2" to 10" Ride Height)	60657-003		010	85072	...
09 - 11	5900i Models with 12,000 lb - 14,000 lb Front axle	2015556C1	-10	85316	89426	
04 - 12	5900i SFA Models with 16,000 lb Front axle	1667520C1	010	85058	89431	
04 - 09	5900i SFA Models with 46,000 lb Neway Rear Air Suspension	2029200C91		010	83126	89430
		90044626		010	83126	89430
	Models with 10,000 to 16,000 lb Front Suspension	3576465C2	010	85999
		3816234C1	010	85999
10 - 13	Models with 12,000 to 14,000 lb Front Taperleaf Suspension	3868264C1	010	85998
- 13	Models with Hendrickson HMX 400/460 Haulmax with 16.5" Saddle	60680-004		01-	83143	...

ProStar - Series

09 - 15	All models with 40,000 lb Rear Air Suspension	3620395C1		010	85931	89458
16 -	All models with 40,000 lb Rear Air Suspension	4050340C1		010	85931	89458
		4050340C2		010	85931	89458
09 - 15	Day Cab models with 14,600 lb Parabolic Taperleaf Front Spring	3813341C3	010	85963
	Day Models with O.E.M. Number	3737576C1		010	85931	89458
13 -	Models with 113" Sleeper Cab	3806341C3	010	85995
		3810581C3	010	85995
		3810581C3	010	85995
		3810581C4	010	85995
-15	Models with Day Cab and 12,000 to 14,000 lb Taperleaf Front Spring Suspension	3606859C1	010	85954
		3606859C2	010	85954
		3606859C3	010	85994
		3812837C1	010	85954
	Models with Day Cab and Air Suspension	3610199C1	010	85964
- 16	Models with Hendrickson HAS - 230 or 460 Rear Air Suspension	3514952C1		010	85976	...
		60675-003		010	85976	...
		H60675-003		010	85976	...
	Models with Hendrickson HTB 400LT Rear Air Suspension	60657-006		010	85102	...
		60657-010		010	85102	...
		60657-011		010	85102	...
		H60657-006		010	85102	...
		H60657-010		010	85102	...
		H60657-011		010	85102	...
	Models with O.E.M. Number	3668566C1	010	85954
		3688729C1		010	85931	89458
		3688732C1		010	85931	89458
		3821760C1		010	85931	89458

APPLICATION GUIDE - TRUCKS, TRAILERS, AND BUSES

Year Año Année	Model Modelo Modèle	OEM #	Front		Rear	
						
						
			Fleetline	GasSLX	Fleetline	GasSLX

INTERNATIONAL (NAVISTAR)(Cont'd.)





ProStar - Series(Cont'd.)

- 14	Models with Sleeper Cab and 12,350 lb Leaf Spring Suspension	3606857C1	OIO	85954
		3606857C2	OIO	85954
14 - 15	Models with Sleeper Cab and 12,350 lb Leaf Spring Suspension	3606857C3	OIO	85994
- 13	Models with Sleeper Cab and Air Suspension	3610198C1	OIO	85963
	Models with Sleeper Cab with O.E.M. Number	3737575C1	OIO	85954

S Series School Bus

	1603, 1703, 1803 & 1853	206620R91	OIO	OIO	83216	...
		206621R91		OIO	83216	...
		306444C91		OIO	85012	89413
		308649C91		OIO	83216	...
		308650C92		OIO	83216	...
		329316C92		OIO	85012	89413
		383379C91		OIO	83308	...
		453564C91		OIO	85012	89413
		453567C91		OIO	83216	...
		453570C91		OIO	83216	...
		453575C91		OIO	83308	...
		467983C91		OIO	85012	89413
		471201C91		OIO	85012	89413
		471203C91		OIO
		474002C91		OIO	83308	...
873622C91	OIO	83308	...			
	1603, 1703, 1803 & 1853 - Exc. Axle Codes 02054, 02057, 02059, 02089, 02091, 02098, 02101, 02109, 02139, 02208, 02218, 02228, 02309, 02329, 02339	308668C92	OIO	85012	89413	
		453556C91	OIO	85012	89413	
		467985C91	OIO	85012	89413	
	1603, 1703, 1803 & 1853 with Axle Codes 02089, 02091	206620R91	OIO	83216
		308649C91	OIO	83216
		453567C91	OIO	83216
		467984C91	OIO	83216
	1603, 1703, 1803 & 1853 with 9000, 10800 or 12000 lb Front Axle	320444C91	OIO	85012	89413	
		329316C92	OIO	85012	89413	
		453564C91	OIO	85012	89413	
		467983C91	OIO	85012	89413	
	1723 S Models with 5000, 6000 or 7500 lb Front Axle	472367C91	- -	83318
	1723, 1823, 1853 Models with International Air Suspension	1675455C1	OIO	OIO	85003	89411
		1690035C1		OIO	85003	89411
		2018987C1		OIO	85003	89411
		2018987C2		OIO	85003	89411
		501553C91		OIO	85003	89411
	1723, 1823, 1853 Models with Neway ARD-234 Air Suspension	537524C91		OIO	83123	89405
	173 FC & 183 FC - Exc. Axle Codes 14149 & 14189	210918R91	OIO	OIO	83215	...
		453574C91		OIO	85307	...
	173 FC & 183 FC with Axle Codes 14149 & 14189	210535R91	OIO	OIO	83225	...
		453568C91		OIO	83225	...
		467372C91		OIO	83225	...
	173 FC, 183 FC, 183RE, 193 RE, 1853 FC & 1853 DFC	204994R91	OIO	83225
		308648C91	OIO	83225

APPLICATION GUIDE - TRUCKS, TRAILERS, AND BUSES

Year Año Année	Model Modelo Modèle	OEM #	Front		Rear	
						
			Fleetline	GasSLX	Fleetline	GasSLX

INTERNATIONAL (NAVISTAR)(Cont'd.)

S Series School Bus(Cont'd.)

173 FC, 183 FC, 183RE, 193 RE, 1853 FC & 1853 DFC	453561C91	010	83225
	453565C91	010	83225
	467371C91	010	83225
1823 S Models - Exc. with Rear Axle Codes 14029,14030, 14187	501906C91		-10	83317	...
1823, 1853 S Models with 9000, 10800 or 12000 lb Front Axle	472411C91	-1-	83456	89447	
	472412C91	-1-	83456	89447	
	586724C91	-1-	83456	89447	
183 RE Models with Axle Codes 14043, 14147 & 14186	210533R91		010	83225	...
	210534R92		010	83225	...
	453562C91		010	83225	...
	467371C91		010	83225	...
1853 DFC3	210920R91	010	85308	89422	
	453579C91	010	85308	89422	
1853 FC & 1853 DFC with Axle Code 14136	210919R91		010	85307	...
	308664C91		010	85307	...
	453574C91		010	85307	...
1853 FC & 1853 DFC with Axle Code 14149 with FD Serial Numbers	453567C91		010	83216	...
1853 FC & 1853 DFC with Axle Codes 14039, 14139, 14149 & 14189 - Exc. 14149 with FD Serial Numbers	210533R91		010	83225	...
	210534R92		010	83225	...
	453562C91		010	83225	...
	467371C91		010	83225	...
1853 FC & 1853 DFC with Axle Codes 14044, 14045, 14060, 14145, 14146, 14150 and 14186	208664C91		010	85307	...
	210919R91		010	85307	...
	453574C91		010	85307	...
193 RE Models	210920R91	010	85308	89422	
	453579C91	010	85308	89422	
193 RE Models - Exc. Axle Codes 14039 & 14189	210533R91		010	83225	...
	210534R92		010	83225	...
	453562C91		010	83225	...
	467371C91		010	83225	...
RE Models	3604282C1	-10	85351

Series 1000 Forward Control Chassis

1452, 1652 Models	453576C92	010	85303	89422	
	472412C91	-1-	83456	89447	
	586724C91	-1-	83456	89447	
1452, 1652 Models with International Air Suspension	1675455C1		010	85003	89411
	1690035C1		010	85003	89411
	2018987C1		010	85003	89411
	2018987C2		010	85003	89411
	501553C91		010	85003	89411
1452, 1652 Models with MOR-RYDE Rear Suspension	548532C1		-1-	83103	...
1654 LP Models (Low Profile Vehicle)	1660846C91		010	83101	...
	1660846C92		010	83101	...
	1663471C1	-1-	83103
	2039565C1	010	83100
M1400, M1600 Models	472412C91	-1-	83456	89447	
	501905C91		-10	83301	...
	586724C91	-1-	83456	89447	

APPLICATION GUIDE - TRUCKS, TRAILERS, AND BUSES

Year Año Année	Model Modelo Modèle	OEM #	Front		Rear	
			Fleetline	GasSLX	Fleetline	GasSLX

INTERNATIONAL (NAVISTAR)(Cont'd.)

Series 2000 - Conventional Truck (Severe Service)(Cont'd.)

2554, 2574, 2654, 2674 Models with International Air Suspension	1675455C1		OIO	85003	89411
	1690035C1		OIO	85003	89411
	2018987C1		OIO	85003	89411
	2018987C2		OIO	85003	89411
	501553C91		OIO	85003	89411
2554, 2574, 2654, 2674 Models with International Vari-Rate Rear Suspension	501506C91		-IO	83317	...
All 2000 Models With 12000 lb Front Axle With 16000 or 18000 lb Springs Without 16000 or 18000 lb Springs	472412C91	-I-	83456	89447	
	1667520C1	OIO	85058	89431	
	2015556C1	-IO	85316	89426	

Series 3000 - School Bus Chassis

3000, 3400 Models with 10,000 to 14,000 lb Front axle	3533357C1	OIO	85957
	3533357C2	OIO	85957
	3533357C3	OIO	85957
3000, 3400 Models with 6,000 to 8,000 lb Front axle	3533356C1	OIO	83135
	3533356C2	OIO	83135
3700, 3800 Models	472412C91	-I-	83456	89447	
	501905C91		-IO	83301	...
	501906C91		-IO	83317	...
	586724C91	-I-	83456	89447	
3700, 3800 Models with International Air Suspension	1675455C1		OIO	85003	89411
	1690035C1		OIO	85003	89411
	2018987C1		OIO	85003	89411
	2018987C2		OIO	85003	89411
	501553C91		OIO	85003	89411
3700, 3800 Models with MOR-RYDE Rear Suspension	548532C1		-I-	83103	...
3700, 3800 Models with Neway ARD-234 Air Suspension	537524C91		OIO	83123	89405
	537525C91		OIO	83123	89405
3900FC Models	1677707C1	OIO	85030	89440	
	2015557C1	OIO	85030	89440	
	467371C91		83225	...	OIO	83225	...
3900FC Models (Genesis - Front Engine)	2200327C1	-IO	85332
3900FC Models (Genesis - Rear Engine)	2039549C1	-IO	85333





Series 400, 500, 600, 700, & 900 - Medium Cabover Truck & Tractor (Nissan)

400 Models	56101 Z5008	-IO	83114
	56101 Z5011	-IO	G63610
500 Models	56101 Z5011	-IO	G63610
600, 700, 900 Models	56101 Z1030	-IO	85311	89424	
	56101 Z2000	-IO	85311	89424	

Series 4000 - Short Conventional Medium Truck & Tractor

4000 Models with Hendrickson HAS-230 Rear Air Suspension	AMS650420		OIO	85013	89414
4600, 4700, 4800, 4900 Models	1663606C91	-I-	85027	89418	
	1667520C1	OIO	85058	89431	
	586724C91	-I-	83456	89447	
4600, 4700, 4800, 4900 Models with 10000 lb Front Axle	472412C91	-I-	83456	89447	
4600, 4700, 4800, 4900 Models with International Air Suspension (Exc. Low Profile)	1675455C1		OIO	85003	89411
	1690035C1		OIO	85003	89411
	2018987C1		OIO	85003	89411
	2018987C2		OIO	85003	89411

APPLICATION GUIDE - TRUCKS, TRAILERS, AND BUSES

Year Año Année	Model Modelo Modèle	OEM #	Front		Rear	
			 Fleetline	 GasSLX	 Fleetline	 GasSLX

INTERNATIONAL (NAVISTAR)(Cont'd.)

Series 4000 - Short Conventional Medium Truck & Tractor(Cont'd.)

	4600, 4700, 4800, 4900 Models with International Air Suspension (Exc. Low Profile)	501553C91		010	85003	89411
	4600LP, 4700LP Models (Low Profile Vehicle) U-Haul	540395C91	-1-	83613
		540395C92	-1-	83613
- 94	4600LP, 4700LP Models (Low Profile Vehicle) U-Haul	1675496C91		010	83636	...
		1675496C92		010	83636	...
02/95-	4600LP, 4700LP Models (Low Profile Vehicle) U-Haul	2039565C1		010	83100	...
	F-4900 & 4600LP Models (Low Profile Vehicle)	501906C91		-10	83317	...
		501906C92		-10	83317	...
90 - 02	F-4900 Models with 10000 lb Front Axle	472412C91	-1-	83456	89447	
90 - 02	F-4900 Models with Dual Doors	2015556C1	-10	85316	89426	
	F-4900 Models with Hendrickson HN - 400 Models Rear suspension	60680-003		01-	83112	...

Series 405

	Models with O.E.M. Number	293009C91	010	85308	89422	
		426744R91	010	85303	89422	
		453576C91	010	85303	89422	
		453577C91	010	85308	89422	

Series 417

	DCO-417 & DCOF-417	426744R91	010	85303	89422	
		453576C91	010	85303	89422	

Series 5000, 5000i - Severe Service Conventional Truck & Tractor

	6 X 4 Models with Neway AD-246-10 Air Suspension and 60" Axle Spacing							
	Heavy Duty	2029200C91		010	85030	89440
		AMS 600172		010	85030	89440
	Standard	2029200C91		010	83126	89430
		AMS 600172		010	83126	89430





Series 7000 - Short Conventional Medium Truck & Tractor

	7000 Models School Bus with O.E.M. Number	3609400C1		-10	83317	...
		3609400C2		-10	83317	...
	7100 Models	1663606C91	-1-	85027	89418	
		472412C91	-1-	83456	89447	
		586724C91	-1-	83456	89447	
	7100 Models with International Air Suspension	1675455C1		010	85003	89411
		1690035C1		010	85003	89411
		2018987C1		010	85003	89411
		2018987C2		010	85003	89411
		501553C91		010	85003	89411
	7300, 7400, 7500, 7600 Models w/ IAS Suspension w/ 5.3" Ride Height	3544766C1		010	85930	...

Series 8000 - Conventional Heavy Duty Tractor

	8100 Models - 6 X 4 & 4 X 2 Models with International Air Suspension for Lo-Profile and Carhauler	1660846C91		010	83101	...
		1660846C92		010	83101	...
	8100 Models Car Hauler	1664524C1		-10	85935	...
		472412C91	-1-	83456	89447	
	8100, 8200, 8300 Models	3000070C91	-1-	83456	89447	
		501906C91		-10	83317	...
	8100, 8200, 8300 Models - with Hendrickson HA-460 Air Suspension with 55" & 60" axle spacing and 40000 & 46000 lb capacity	AMS 600102		010	85005	89430
	8100, 8200, 8300 Models with 12000 - 14000 lb Suspension	1664788C2	-10	85316	89426	

APPLICATION GUIDE - TRUCKS, TRAILERS, AND BUSES

Year Año Année	Model Modelo Modèle	OEM #	Front		Rear	
						
			Fleetline	GasSLX	Fleetline	GasSLX

INTERNATIONAL (NAVISTAR)(Cont'd.)

Series 8000 - Conventional Heavy Duty Tractor(Cont'd.)

	8100, 8200, 8300 Models with 12000 - 14000 lb Suspension	2015556C1	-IO	85316	89426		
	8100, 8200, 8300 Models with 15000 - 18000 lb Suspension	1667520C1	OIO	85058	89431		
	8100, 8200, 8300 Models with Hendrickson HA-230 Rear Air Suspension	AMS 600102		OIO	85005	89430	
	8100, 8200, 8300 Models with International Air Suspension (Except Lo-Profile and Carhauler)	1675455C1		OIO	85003	89411	
		1690035C1		OIO	85003	89411	
		2018987C1		OIO	85003	89411	
		2018987C2		OIO	85003	89411	
		501553C91		OIO	85003	89411	
07 - 08	8600 Models with Taperleaf Front Spring Suspension	3670156C1	OIO	85954	
	Models with Neway AD-246-10 Air Suspension and 60" Axle Spacing	Heavy Duty		OIO	85030	89440	
				AMS 600172	OIO	85030	89440
		Standard		2029200C91	OIO	83126	89430
				AMS 600172	OIO	83126	89430





Series 9100, 9100i - Tractor & Straight Truck

	6 X 4 Models with International Air Suspension For Lo-Profile	1660846C91		OIO	83101	...	
		1660846C92		OIO	83101	...	
	6 X 4 Models with Neway AD-246-10 Air Suspension and 60" Axle Spacing	Heavy Duty		OIO	85030	89440	
				AMS 600172	OIO	85030	89440
		Standard		2029200C91	OIO	83126	89430
				AMS 600172	OIO	83126	89430
	9100 Models - with Hendrickson HA-460 Models Air Suspension	AMS 600102		OIO	85005	89430	
	9100 Models with 12000 - 14000 lb Suspension	1664788C2	-IO	85316	89426		
		2015556C1	-IO	85316	89426		
		2032533C1	-IO	85316	89426		
	Models with International Air Suspension (Except Lo-Profile)	2018987C1		OIO	85003	89411	
		2018987C2		OIO	85003	89411	

Series 9200, 9200i - Tractor & Straight Truck

	4 X 2 Models with International Air Suspension	2018987C1		OIO	85003	89411	
		2018987C2		OIO	85003	89411	
- 08//94	4 X 2 Models with International Air Suspension	1675496C91		OIO	83636	...	
		1675496C92		OIO	83636	...	
	6 X 4 Models with 12,000 to 14,000 lb Front Axles	3581109C3	OIO	85924	89457		
		3581109C4	OIO	85924	89457		
	6 X 4 Models with International Air Suspension	2018987C1		OIO	85003	89411	
		2018987C2		OIO	85003	89411	
	6 X 4 Models with International Air Suspension For Lo-Profile	1660846C91		OIO	83101	...	
		1660846C92		OIO	83101	...	
		Heavy Duty	2029200C91		OIO	85030	89440
			AMS 600172		OIO	85030	89440
		Standard	2029200C91		OIO	83126	89430
			AMS 600172		OIO	83126	89430
	Models with 12,000 - 18,000 lb Suspension	1664788C2	-IO	85316	89426		
		2015556C1	-IO	85316	89426		
		2032533C1	-IO	85316	89426		
00 - 09	Models with 12,000 lb Front Axle	3581107C1	OIO	85924	89457		
		3581107C2	OIO	85924	89457		

APPLICATION GUIDE - TRUCKS, TRAILERS, AND BUSES

Year Año Année	Model Modelo Modèle	OEM #	Front		Rear	
						
			Fleetline	GasSLX	Fleetline	GasSLX

INTERNATIONAL (NAVISTAR)(Cont'd.)

Series 9200, 9200i - Tractor & Straight Truck(Cont'd.)

00 - 09	Models with 12,000 lb Front Axle	3581107C3 3584535C3	○ ○	85924	89457	
			○ ○	85924	89457	
04 - 09	Models with 40,000 lb Rear Air Suspension	3586883C1		○ ○	85931	89458
	Models with Day Cab & Hendrickson AirTek Suspension	3613984C1 3660549C1 65992-002	○ ○	85955
			○ ○	85955
			○ ○	85955
	Models with Hendrickson HA-460 Models Air Suspension	AMS 600102		○ ○	85005	89430
	Models with IAS Suspension w/ 9.25" or 9.5" Ride Height	3573265C1		○ ○	85931	89458
	Models with International Air Suspension	1675455C1 1690035C1 501553C91		○ ○	85003	89411
				○ ○	85003	89411
				○ ○	85003	89411
	Models with Sleeper Cab & Hendrickson AirTek Suspension	3609178C1 3660548C1 65992-001	○ ○	85955
			○ ○	85955
			○ ○	85955





Series 9300, 9300i, 9400 & 9400i Long Hood Conventional Truck & Tractor

	6 X 4 Models with International Air Suspension Exc. Lo-Profile	2018987C1 2018987C2		○ ○	85003	89411
				○ ○	85003	89411
	6 X 4 Models with International Air Suspension For Lo-Profile Heavy Duty Standard	1660846C91 1660846C92 2029200C91 AMS 600172 2029200C91 AMS 600172		○ ○	83101	...
				○ ○	83101	...
				○ ○	85030	89440
				○ ○	85030	89440
				○ ○	83126	89430
				○ ○	83126	89430
	Models with 10,800 lb Suspension	503610C2	○ ○	83207	89407	
	Models with 12,000 - 14,000 lb Suspension	1664788C2 2015556C1 2032533C1	- ○	85316	89426	
			- ○	85316	89426	
			- ○	85316	89426	
00 - 09	Models with 12,000 lb Front Axle	3581107C1 3581107C2 3581107C3 3584535C3	○ ○	85924	89457	
			○ ○	85924	89457	
			○ ○	85924	89457	
			○ ○	85924	89457	
	Models with 16,000 - 18,000 lb Suspension	1667520C1	○ ○	85058	89431	
04 - 09	Models with 40,000 lb Rear Air Suspension	3586883C1		○ ○	85931	89458
	Models with Day Cab & Hendrickson AirTek Suspension	3613984C1 3660549C1 65992-002	○ ○	85955
			○ ○	85955
			○ ○	85955
	Models with Hendrickson HA-460 Models Air Suspension	AMS 600102		○ ○	85005	89430
	Models with IAS Suspension w/ 9.25" or 9.5" Ride Height	3573265C1		○ ○	85931	89458
	Models with International Air Suspension	1675455C1 1690035C1 501553C91		○ ○	85003	89411
				○ ○	85003	89411
				○ ○	85003	89411
	Models with Neway ARD-125/244 Air Suspension	790335C91		○ ○	83209	89414
	Models with Sleeper Cab & Hendrickson AirTek Suspension	3609178C1 3660548C1 65992-001	○ ○	85955
			○ ○	85955
			○ ○	85955
	Set Back Axle Models with 16,000 lb to 18,000 lb Suspension	1664149C1	○ ○	85029
	Set Foreward Axle Models with 16,000 lb to 18,000 lb Suspension	507202C1	○ ○	85030	89440	

Series 9600 & 9700 Premium Cabover Tractor

	9600, 9700 Models	507202C1	○ ○	85030	89440	
	9600, 9700 Models Except Low Profile	1664788C2	- ○	85316	89426	

APPLICATION GUIDE - TRUCKS, TRAILERS, AND BUSES

Year Año Année	Model Modelo Modèle	OEM #	Front		Rear	
						
				Fleetline	GasSLX	Fleetline

INTERNATIONAL (NAVISTAR)(Cont'd.)

Series 9600 & 9700 Premium Cabover Tractor(Cont'd.)

	9600, 9700 Models Except Low Profile	2015556C1	-10	85316	89426	
	9600, 9700 Models for Low Profile	503610C2	010	83207	89407	
	9600, 9700 Models with 16000 - 18000 lb Suspension	1667520C1	010	85058	89431	
	9600, 9700 Models with Hendrickson HA-460 Air Suspension with 55" or 60" axle spacing and 40000 or 46000 lb capacity	AMS 600102		010	85005	89430
	9600, 9700 Models with International STL Spring Suspension	503550C1		010	83207	89407
	9600, 9700 Models with Neway ARD-125/244 Air Suspension	790335C91		010	83209	89414
	9600, 9700 Models with Neway ARD-234 Air Suspension	537524C91		010	83123	89405
	Models with International Air Suspension	1675455C1		010	85003	89411
		1690035C1		010	85003	89411
		2018987C1		010	85003	89411
		2018987C2		010	85003	89411
		501553C91		010	85003	89411





Series 9800 - Premium Cabover Tractor

	6 X 4 Models with International Air Suspension Heavy Duty Standard	2018987C1		010	85003	89411
		2018987C2		010	85003	89411
		2029200C91		010	85030	89440
		AMS 600172		010	85030	89440
		2029200C91		010	83126	89430
	AMS 600172		010	83126	89430	
	9800 Models - with Hendrickson HA-460 Air Suspension with 55" & 60" axle spacing and 40000 & 46000 lb capacity	AMS 600102		010	85005	89430
	9800 Models - with Hendrickson HAS-402-60 Air Suspension	AMS 650420		010	85013	89414
	9800 Models - with Set Back axle	2015556C1	-10	85316	89426	
	9800 Models - with Set Forward axle	503610C2	010	83207	89407	

Series 9900, 9900i, 9900ix Long Hood Conventional Truck

	6 X 4 Models with International Air Suspension Exc. Lo-Profile	2018987C1		010	85003	89411
		2018987C2		010	85003	89411
	6 X 4 Models with International Air Suspension For Lo-Profile Heavy Duty Standard	1660846C91		010	83101	...
		1660846C92		010	83101	...
		2029200C91		010	85030	89440
		AMS 600172		010	85030	89440
		2029200C91		010	83126	89430
	AMS 600172		010	83126	89430	
- 11	Day Cab Models with 12,000 lb Front Axles	3581106C1	010	85924	89457	
		3581106C2	010	85924	89457	
		3581106C3	010	85924	89457	
	Models with 10,800 lb - 14,600 lb Suspension	503610C2	010	83207	89407	
	Models with 12,000 - 14,000 lb Suspension	1664788C2	-10	85316	89426	
		2015556C1	-10	85316	89426	
		2032533C1	-10	85316	89426	
04 - 09	Models with 12,000 lb Front axle	3584535C3	010	85924	89457	
13 -	Models with 12,000 lb Front axle	3810581C3	010	85995
		3810581C4	010	85995
	Models with 16,000 - 18,000 lb Suspension	1667520C1	010	85058	89431	
04 - 11	Models with 40,000 lb Rear Air Suspension	3586883C1		010	85931	89458
02 - 16	Models with Hendrickson HAS - 230 or 460 Rear Air Suspension	3514952C1		010	85976	...
		60675-003		010	85976	...
		H60675-003		010	85976	...
- 16	Models with International 40,000 lb Rear Air Suspension (52" Spacing- Heavy Duty Rear)	3688616C1		010	85923	89458

APPLICATION GUIDE - TRUCKS, TRAILERS, AND BUSES

Year Año Année	Model Modelo Modèle	OEM #	Front			Rear		
							Fleetline	GasSLX

INTERNATIONAL (NAVISTAR)(Cont'd.)

Series 9900, 9900i, 9900ix Long Hood Conventional Truck(Cont'd.)

	Models with International Air Suspension	1675455C1		010	85003	89411
		1690035C1		010	85003	89411
		501553C91		010	85003	89411
	Models with Neway ARD-125/244 Air Suspension	790335C91		010	83209	89414
	Set Back Axle Models with 16,000 lb to 18,000 lb Suspension	1664149C1	010	85029
	Set Foreward Axle Models with 16,000 lb to 18,000 lb Suspension	507202C1	010	85030	89440	

TerraStar

2014	4 WD Models with Rear Spring Suspension	3945165C1		010	83180	...
12	Models with 6,000 to 7,000 lb Front Axle	3902993C1	010	83167
		OE17103	010	83167
13 - 14	Models with 6,000 to 7,000 lb Front Axle	3902993C3	010	83135
		OE 18513	010	83135
	Models with International IROS Air Suspension	3892445C3		010	85931	89458
12	Models with O.E.M. Number	6E7Z-18125-A		010	83146	...

TranStar - 8500, 8600 Series

03 - 15	Models with 12,000 lb Front axle	3533357C1	010	85957
		3533357C2	010	85957
		3588209C1	010	85957
		3588209C2	010	85957
03 - 13	Models with 40,000 lb Rear Air Suspension	3549099C1		010	85923	89458
		3549099C2		010	85923	89458
- 13	Models with O.E.M. Number	3674348C1	010	85954

Transtar - Conventional

	4170, F-4170, 4200, F-4200, 4300 & F-4300 Models	426744R91	010	85303	89422	
		426744R92	010	85303	89422	
		453576C91	010	85303	89422	
		453576C92	010	85303	89422	
		477132C1	010	85303	89422	
	4170, F-4170, 4200, F-4200, 4300 & F-4300 with Air Ride Suspension	350425C1		010	85300	89419
		462557C91		010	85300	89419
	D-400, DF-400, DC-400, DCF-400 & DCF-400M - Exc. Axle Code 02136	426744R91	010	85303	89422	
		426744R92	010	85303	89422	
		453576C91	010	85303	89422	
	D-400, DF-400, DC-400, DCF-400 & DCF-400M with Axle Code 02136	293009C91	010	85308	89422	
		453577C91	010	85308	89422	





Unistar

	CO7044A	426744R91		85303	...	010	85303	89422
		426744R92		85303	...	010	85303	89422
		453576C91		85303	...	010	85303	89422
	Additional O.E.M. Interchanges	56101 Z5008	-10				83114	
		596329C1	010				85014	

WorkStar - 7000 Series

	7300, 7400, 7500, 7600 Models with 16,000 lb to 20,000 lb Multi-leaf Spring	Severe Duty	3541456C1	010	85929	
			Standard	3558089C1	010	85925
				3558089C2	010	85925
				3558089C3	010	85925

APPLICATION GUIDE - TRUCKS, TRAILERS, AND BUSES

Year Año Année	Model Modelo Modèle	OEM #	Front		Rear	
						
			Fleetline	GasSLX	Fleetline	GasSLX

INTERNATIONAL (NAVISTAR)(Cont'd.)

WorkStar - 7000 Series(Cont'd.)

04 - 15	7400, 7500, 7600 Models with 12,000 lb Front axle	3533357C1	010	85957
		3533357C2	010	85957
		3533357C3	010	85957
- 16	7400, 7500, 7600 Models with 18,000 lb Front Axles	3576464C1	010	85957
		3576464C2	010	85957
	7400, 7500, 7600 Models with Hendrickson HAS - 400 (Standard Inboard Rear)	60670-007		010	83144	...
	Models with 10,000 to 16,000 lb Front Suspension	3576465C2	010	85999
		3816234C1	010	85999
10 - 13	Models with 12,000 to 14,000 lb Front Taperleaf Suspension	3868264C1	010	85998
02 - 16	Models with Hendrickson HAS - 230 or 460 Rear Air Suspension	3514952C1		010	85976	...
		60675-003		010	85976	...
		H60675-003		010	85976	...
- 14	Models with Hendrickson HMX 400/460 Haulmax with 16.5" Saddle	60680-004		01-	83143	...
- 15	Models with Hendrickson Primaax 230, 460 and 690 Air Suspension (8-1/2" to 10" Ride Height)	60657-003		010	85072	...
- 15	Models with Hendrickson Primaax EX 232, 462 and 692 Air Suspension (8-1/2" to 10" Ride Height)	60657-003		010	85072	...
	S7700 Models w/ Multistage Front Suspension	3588591C1	010	85953
		3588591C2	010	85953
		3588592C1	010	85953
		3588592C2	010	85953
	Additional O.E.M. Interchanges	453527C91	-10	85311 or 89424				
		453528C91	-10	85311 or 89424				
		462603C91	-1-	85705 or 89447				
		463926C91	-1-	85705 or 89447				

Additional O.E.M. Interchanges

	Models with Chalmers 40,000 lb Rear Suspension	800670		010	85060	...
	Models with Meritor AirLink Suspension	446-51-211		010	85739	...
	Models with O.E.M. Number	3000098C1		-10	83317	...
		3571711C1	-10	85316	89426	
		3581109C1	010	85924	89457	
		3584116C1	010	83175
		3584116C2	010	83175
		3584117C1	010	83135
		3584117C2	010	83135
		3584118C1	010	85928
		3584118C2	010	85928
		3584535C1	010	85924	89457	
		3584535C2	010	85924	89457	
		3586902C2		010	83146	...
		3601600C1	010	85082				
		3601600C2	010	85082				
		3601600C3	010	85082				
		47902-24		010	83137	...
	4C4Z-18124-N	010	85957	
	4C4Z-18125-DA		010	85926	...	
	503610C1		010	83207	89407	
	90044025		010	83209	89414	
	Additional O.E.M. Interchanges	3541456C1	010	85929				
		3544768C1	010	85926				

APPLICATION GUIDE - TRUCKS, TRAILERS, AND BUSES

Year Año Année	Model Modelo Modèle	OEM #	Front		Rear	
			Fleetline	GasSLX	Fleetline	GasSLX

INTERNATIONAL (NAVISTAR)(Cont'd.)





Additional O.E.M. Interchanges(Cont'd.)

Additional O.E.M. Interchanges	3549100C1	010		85926
	3558989C1	010		85925
	3558989C2	010		85925
	3571713C1	-10		85333
	3596107C1	010		85927
	3596107C2	010		85927
	70334	-10		85316 or 89426
	AMS650102	010		85001 or 89410
	AMS650107	-10		85316 or 89426
	AMS650400	-10		85033 or 89427
	AMS650402	-10		85311 or 89424
	AMS650404	-1-		85310 or 89423
	AMS650405	010		85023 or 89415
	AMS650406	010		85024 or 89416
	AMS650408	-10		85319 or 89428

INTERNATIONAL (NAVISTAR) CAB SHOCKS

	1900A, 2000A Models - Fleetstar Conventional	480945C1	-1-		83014
		480945C2	-1-		83014
97 -	Eagle Pro-Sleeper	1202-0054	010		83021
09 - 15	LoneStar Models with 72" Hi Roof Sleeper	2595314C1	01-		83062
		2600491C91	01-		83062
	Models with Link Cab Suspension NPS90	1202-0054	010		83021
	Models with Link Cabmate Suspensions with O.E.M. Number	1201-1043	010		83025
		1201-1049	010		83025
		1201-9003	010		83052
		1201-9007	010		83054
		1201-9009	010		83054
		1201-9013	01-		83062
		1201-9014	01-		83062
		1201-9018	01-		83062
		1201-9021	01-		83062
		1202-0012	010		83023
		1202-0022	010		83046
		1202-0032	010		83016
		1202-0042	010		83025
		1202-0043	010		83032
		1202-0044	010		83025
		1202-0054	010		83021
1202-1212	010		83013		
1202-1213	01-		83005		
	Models with O.E.M. Number	1201-1212	010		83013
		1201-1213	01-		83005
		2012768C1	010		83013
		2012769C2	01-		83005
		2023685C1	01-		83015
		2025790C1	010		83013
		2500013C1	010		83013
		2507409C1	010		83052
		2507761C1	010		83052
2507763C1	010		83052		

APPLICATION GUIDE - TRUCKS, TRAILERS, AND BUSES

Year Año Année	Model Modelo Modèle	OEM #	Front		Rear	
						
			Fleetline	GasSLX	Fleetline	GasSLX

INTERNATIONAL (NAVISTAR) CAB SHOCKS(Cont'd.)

	Models with O.E.M. Number	2507948C1	010	83054
		2508326C1	010	83021
		2508327C1	010	83025
		2590915C1	01-	83062
		2590916C1	01-	83062
		2597458C91	01-	83062
		2601488C91	01-	83062
		2602021C1	01-	83062
		3557165C1	010	83053
		3557166C1	010	83052
		3557167C3	010	83053
		3557169C1	010	83052
		3557169C2	010	83052
		3560649C1	010	83052
		3560649C2	010	83052
		3560705C2	010	83054
		AMS66160	010	83052
		AMS66161	010	83053
		OE14771	01-	83062
- 91	Navistar 60" Sleepers with Link Cabmate Model IHS60	1202-1043	010	83025
11 - 15	Pro-Star Models With 56" or 72" Hi Roof Sleeper	2593803C91	01-	83062
		2595314C1	01-	83062
	S2500, S2600, 8100, 8200, & 8300 Models Conventional Tractors with Link Cabmate Model NAV80	1202-1043	010	83025

4000 Series

	Cabover Tractors with 74", 84" or 88" cabs with Link Cabmate Model IHB-2P	1202-0032	010	83016
	Conventional Tractors with Link Cabmate Model IHC43	1201-0012	010	83023
		1202-0012	010	83023
- 17	DuraStar - 4300, 4400 Models Conventional Tractors with O.E.M. Number	2509221C91	010	83054
	HPV 4000 Models travel crew cabs with ITC 42 Link Cabmate Model	1201-9002	010	83052

5000 Series

09/94 -	Paystar - SBA Conventionals with Link Cabmate Model NP50 & NP50-A built after August of 1994	1201-1044	010	83025
		1202-1044	010	83025
09/96 -	Paystar - SFA Conventionals with Link Cabmate Model NP50 & NP50-A built after August of 1996	1201-1044	010	83025
		1202-1044	010	83025

7000 Series

	7300, 7400 & 7500 Models trucks with day cab or extended cabs with Link Cabmate Model IDC734	1201-9001	010	83052
	7300, 7400 & 7500 Models trucks with day cab or extended cabs with Link Cabmate Model IDC7345	1201-9008	010	83054
	7600 Models trucks with day cab or extended cabs with Link Cabmate Model IDC76	1201-9010	010	83053
- 15	WorkStar - 7000 Models Models with O.E.M. Number	2509224C91	010	83053
- 16	WorkStar - 7000 Models Models with O.E.M. Number	2509223C91	010	83054

8000 Series

	8500 Model trucks with day cab or extended cabs with Link Cabmate Model IDC85	1201-9008	010	83054
	8600 Model trucks with day cab or extended cabs with Link Cabmate Model IDC86	1201-9011	010	83053
- 13	TranStar - 8500, 8600 Models Tractors with O.E.M. Number	2509223C91	010	83054

APPLICATION GUIDE - TRUCKS, TRAILERS, AND BUSES

Year Año Année	Model Modelo Modèle	OEM #	Front		Rear	
			Fleetline	GasSLX	Fleetline	GasSLX

INTERNATIONAL (NAVISTAR) CAB SHOCKS(Cont'd.)

8000 Series(Cont'd.)

04 - 09	TranStar - 8500, 8600 Models Tractors with 36" Sleepers	2509222C91	0 0	83053
---------	---	------------	-----	-------

9000 Series

01/93-	48" & 60" Bentz Sleepers on 9000 Models Conventional Tractors with Link Cabmate Model IHS4860	1201-1044	0 0	83025
		1202-1044	0 0	83025
03/97 -	9100 & 9200 Models Conventionals with Link Cabmate Model ND92-A	1202-1043	0 0	83025
		9200 Models with O.E. Number	2023684C1	0 -
	9300 & 9400 Conventional Tractors with Link Cabmate Model IHC93-A	1202-1043	0 0	83025
		2503529C1	0 0	83025
81 -	9670 Cabover Tractors with 89" or 110" cabs with Link Cabmate Models IH967-A or IH97110	1202-0032	0 0	83016
82 -	9670, 9700 & 9800 Cabovers with 89" & 110" cabs with Link Cabmate Model NAV9876	1202-0054	0 0	83021
89 -	9700 Cabover Tractors with 110" cabs with Link Cabmate Model IH97110	1202-0032	0 0	83016
89 -	9700 Cabover Tractors with 89" cabs with Link Cabmate Model IH9789	1202-0032	0 0	83016
04 - 09	Models With 51" Low-Roof Sleeper	1201-0154	0 0	83051
		2585145C1	0 0	83051
04 - 09	Models with 72" High-Roof Sleeper	1201-0254	0 0	83051
		2589922C1	0 0	83051

ISUZU

FTR Series

05 - 09	FTR Models with 15000, 19000, 21000 lb Multileaf Springs	15174902		- -	85071	...
		88982686		- -	85071	...
05 - 09	FTR Models with O.E.M. Number	15123676	- -	83136	...			
		88982682	- -	83136	...			
		8-98098-059-0	- -	0 0	83159	...
		8-98098-127-0	- 0	83515	...			
		8982326720	- 0	83515	...			
		98098059	- 0	0 0	83159	...
	98098127	- 0	83515	...				





FVR Series

90 - 09	FVR Models with 15000, 19000, 21000 lb Multileaf Springs	88982686		- -	85071	...
09	FVR Models with Hendrickson HAS suspension	12474915		0 0	83122	89406
		60670-005		0 0	83137	...
00 - 09	FVR Models with O.E.M. Number	15887728	- -	83136	...			
		19152843	- -	83136	...			

NPR Series

86 - 95	NPR Models (NPC & NPN)	51630666		0 0	85012	89413
		8-94454-647-1	- 0	83515	...			
		8-94454-986-0	- 0	83515	...			
		8-94454-987-0	- 0	83515	...			
		8-97083-029-0	- 0	83515	...			
		94454986	- 0	83515	...			
		9-51630-666-0	- 0	0 0	85012	89413
		9-51630-666-2	- 0	0 0	85012	89413
	97083029	- 0	83515	...				
89 - 90	NPR Models Flatlow	51630647	- 0	83515	...			
		9-51630-647-1	- 0	83515	...			

APPLICATION GUIDE - TRUCKS, TRAILERS, AND BUSES

Year Año Année	Model Modelo Modèle	OEM #	Front		Rear	
						
			Fleetline	GasSLX	Fleetline	GasSLX

ISUZU(Cont'd.)

NPR Series(Cont'd.)

89 - 92	NPR Models Flatlow	9-51630-666-0		010	85012	89413
		9-51630-666-2		010	85012	89413
01 - 07	NPR, NPR-HD (Diesel Models)	8-97253-651-2		010	83404	...
		97253651		010	83404	...
03 - 08	NPR, NPR-HD (Gas Models)	8-97253-651-2		010	83404	...
		97253651		010	83404	...
95 - 02	NPR, NPR-HD (Gas & Diesel Models)	8-97253-664-0		010	83159	...
		97253664		010	83159	...
86 - 14	NPR, NPR-HD Models with 11000 lb & 13000 lb Suspension	8-94454-987-0	-10	83515
		8-97083-027-0	-10	83515
		8-97083-029-0	-10	83515
		8-97253-620-0	-10	83515
		8-97253-620-1	-10	83515
		8-98098-125-0	-10	83515
		8982326710	-10	83515
		94454987	-10	83515
		97083027	-10	83515
		97083029	-10	83515
		97253620	-10	83515
		98098125	-10	83515
03 - 14	NPR, NPR-HD Models with O.E.M Number	8-97253-665-0		010	83159	...
		8-98098-058-0		010	83159	...
		8-98098-058-1		010	83159	...
		898098-0581		010	83159	...
		8-98098-059-0		010	83159	...
		97253665		010	83159	...
		98098058		010	83159	...
		98098059		010	83159	...





NQR Series

02	NQR (Diesel)	8-97253-664-0		010	83159	...
		97253664		010	83159	...
95 - 97	NQR (Diesel)	8-97253-664-0		010	83159	...
		97253664		010	83159	...
03 - 12	NQR Models with O.E.M. Number	8-97253-620-0	-10	83515
		8-97253-665-0		010	83159	...
		8-98098-059-0		010	83159	...
		8-98098-127-0	-10	83515
		8982326720	-10	83515
		97253620	-10	83515
		97253665		010	83159	...
		98098059		010	83159	...
98098127	-10	83515		

NRR Series

88 - 99	NRR Models (All)	1-51630-217-0	-10	83114
		1-51630-217-1	-10	83114
		1-51630-219-1	-10	83114
		51630217	-10	83114
02 - 12	NRR Models with O.E.M. Number	8-97253-620-0	-10	83515
		8-97253-665-0		010	83159	...
		8-98098059-0		010	83159	...
		8-98098-127-0	-10	83515

APPLICATION GUIDE - TRUCKS, TRAILERS, AND BUSES

Year Año Année	Model Modelo Modèle	OEM #	Front		Rear	
						
			Fleetline	GasSLX	Fleetline	GasSLX

ISUZU(Cont'd.)

NRR Series(Cont'd.)

02 - 12	NRR Models with O.E.M. Number	8982326720 97253620 97253665 98098059 98098127	-10	83515	
			-10	83515	
				010	83159
				010	83159
			-10	83515

Additional Applications









95 -	FRR Models (All)	1-51630-219-1 51630219	-10	83114
			-10	83114
86 - 92	FSR Models	1-51630-168-1 1-51630-217-1 51630168	-10	83515
			-10	83114
			-10	G63610
85	KS22 Models (All)	8-97083-027-0 9-51630-666-0 9-51630-666-2	-10	83515
				010	85012	89413
				010	85012	89413
	Models with O.E.M. Number	8-22064-231-0 8-22064-232-0 8-22064-233-0 8-22064-489-0 8-22064-804-0 8-22064-805-0 8-22064-806-0 8-22064-807-0 8-51630-666-0 8972019600 8-97253-616-0 8-97253-621-0 8-97253-623-0 898098-1250 898098-1270 94033786	-10	-1-	85324	...
				-1-	85071	...
			-1-	83136
				-1-	85336	...
			-1-	83136
			-1-	83136
			-1-	83136
			-1-	83136
				010	85012	89413
			-10	83515
			-10	83515
			-10	83515
			-10	83515
			-10	83515
			-10	83515
			-10	83114

ITASCA

Class A MotorHomes

06	Ellipse Series MotorHomes with Freightliner XC Chassis ADL200 Suspension w/ 20K Rear AS120 Front Suspension Rear Shock with O.E.M. Number ZF - IFS Front Suspension with 23,000 lb GVW or Greater	16-16873-000 141700131810 16-16737-000 16-16874-000 141700131809 16-16736-000 16-18103-000 481700000493	010	010	85029	...
			010	83160
			010	83160
			010	83160
				010	85029	...
				010	85029	...
			-1-	85900
-1-	85900			
04 - 06	Horizon Series MotorHomes with Freightliner XC Chassis ADL200 Suspension w/ 20K Rear AS120 Front Suspension Rear Shock with O.E.M. Number ZF - IFS Front Suspension with 23,000 lb GVW or Greater	16-16873-000 141700131810 16-16737-000 16-16874-000 141700131809 16-16736-000 16-18103-000 481700000493	010	010	85029	...
			010	83160
			010	83160
			010	83160
				010	85029	...
				010	85029	...
			-1-	85900
-1-	85900			

APPLICATION GUIDE - TRUCKS, TRAILERS, AND BUSES

Year Año Année	Model Modelo Modèle	OEM #	Front		Rear	
						
						
			Fleetline	GasSLX	Fleetline	GasSLX

KENWORTH(Cont'd.)

C500, C500B, C500K, C540 & C550(Cont'd.)

	Models with Neway ADZ Rear Suspension	90045605		OIO	85109	...
- 09	Models with Taper Leaf Springs on Front Axle	B71-1002	OIO	85001	89410	
		K374-16	OIO	85001	89410	
		K374-26	OIO	85001	89410	
		K374-27	OIO	85001	89410	

ICON 900

16 - 17	Models with 10,000 lb to 14,600 lb Taperleaf Springs and Set Back Front Axles	B71-6019	OIO	85989
16 - 17	Models with Air Glide 380 (AG380) Rear Air Suspension	C71-1016		OIO	85067	89451
		C71-6015		OIO	85067	89451
16 - 17	Models with Air Glide 400 (AG400) Rear Air Suspension	C71-1014		OIO	85936	89456
16 - 17	Models with Air Glide 460 (AG460) Rear Air Suspension	C71-1015		OIO	85937	...
		C71-1015 PLUS		OIO	85937	...
2016	Models with Taper Leaf Springs on Front Axle	B71-1002	OIO	85001	89410	

K100, K100E, K125

	All with Air Glide 100 Suspension with 8 air bags, 4 units required	K374-29		- -	85310	89423
		K374-32		- -	85310	89423
	All with Air Glide 200 with 40,000 lb Suspension with 8 air bags, 4 units required	665903		- -	85900	...
		665944		- -	85900	...
		70701		- -	85900	...
	All with Air Glide 200 with 46,000 lb Suspension with 8 air bags, 4 units required	665906		- -	85902	...
		665945		- -	85902	...
	Models with Dual Steering Front Axle and Torsion Bar Bogey Rear Suspension	K374-28		OIO	85314	89425
		K374-4		OIO	85314	89425
	Models with Multiple Leaf Springs on Front Axle	B71-1003	OIO	83312	89409	
		K374-3	OIO	83312	89409	
		K374-33	OIO	83312	89409	
	Models with Set Back Front Axle	665331	OIO	83353
		K374-13	OIO	83353
		K374-13-1	OIO	83353
	Models with Taper Leaf Springs on Front Axle	B71-1002	OIO	85001	89410	
		K374-16	OIO	85001	89410	
		K374-26	OIO	85001	89410	
		K374-27	OIO	85001	89410	

K270, K370

13 - 17	Models with 21,000 to 23,000 lb Reyco Spring Suspension	19495-01		OIO	83126	89440
		TK19679		OIO	83126	89440
13 - 16	Models with Hendrickson HAS - 230L Rear Air Suspension	60670-008		OIO	83123	89405
13 - 17	Models with Reyco 102 or 79KB Suspension (Drive Axle)	16725-01		OIO	83221	...

K300, T300

	All with Air Glide 100 Suspension with 8 air bags, 4 units required	K374-29		- -	85310	89423
		K374-32		- -	85310	89423
	All with Air Glide 200 with 40,000 lb Suspension with 8 air bags, 4 units required	665903		- -	85900	...
		665944		- -	85900	...
		70701		- -	85900	...
	All with Air Glide 200 with 46,000 lb Suspension with 8 air bags, 4 units required	665906		- -	85902	...
		665945		- -	85902	...

APPLICATION GUIDE - TRUCKS, TRAILERS, AND BUSES

Year Año Année	Model Modelo Modèle	OEM #	Front		Rear	
			Fleetline	GasSLX	Fleetline	GasSLX

KENWORTH(Cont'd.)

K300, T300(Cont'd.)

	K300 COE Medium Duty	665565	○ ○	85007	89412	
	Models with Hendrickson Rear Air Suspension	47902-19		○ ○	83123	89405
	Models with Multiple Leaf Springs on Front Axle	B71-1003	○ ○	83312	89409	
		K374-3	○ ○	83312	89409	
		K374-33	○ ○	83312	89409	
	Models with O.E.M. Number	665617	○ ○	85031
		B71-1000	○ ○	85031
	Models with Reyco 102 or 79KB Suspension (Drive Axle)	16725-01		○ ○	83221	...
	Models with Reyco 1209 or 1212 Suspension (Steer Axle)	19495-01	○ ○	83126	89440	
	Models with Taper Leaf Springs on Front Axle	B71-1002	○ ○	85001	89410	
		K374-16	○ ○	85001	89410	
		K374-26	○ ○	85001	89410	
		K374-27	○ ○	85001	89410	
	Models with Woodhead Shock (Stamping Number ACHB 966)	ACHB966		- -	83136	...

T170

08 - 13	Models with 8,000 lb Dana Front Axle	665617	○ ○	85031
08 - 13	Models with Reyco 79KB Rear Suspension	16725-01		○ ○	83221	...

T270, T370

10 - 14	Models with 10,000 lb to 12,000 lb Front Axle	B71-6005	○ ○	85084	89460	
15 - 17	Models with 10,000 lb to 14,600 lb Taperleaf Springs and Set Back Front Axles	B71-6019	○ ○	85989
08 - 09	Models with 12,000 lb Front Axle	665617	○ ○	85031
10 - 14	Models with 13,200 lb to 14,600 lb Front Axle	B71-6006	○ ○	85084	89460	
10 - 17	Models with 21,000 to 23,000 lb Reyco Spring Suspension	19495-01		○ ○	83126	89440
		TK19679		○ ○	83126	89440
10 - 14	Models with 8,000 lb Front Axle	B71-6004	○ ○	85084	89460	
08 - 17	Models with AG210L Rear Air Suspension	C71-1011		- -	85069	89455
		C71-1017		- -	85069	89455
08 - 17	Models with Hendrickson HAS - 230L Rear Air Suspension	60670-008		○ ○	83123	89405
10 - 14	Models with Hendrickson HAS - 400 (Standard) Rear Air Suspension	60670-005		○ ○	83137	...
10 - 17	Models with Reyco 102 or 79KB Suspension (Drive Axle)	16725-01		○ ○	83221	...

T400, T400B, T450B

	All with Air Glide 100 Suspension with 8 air bags, 4 units required	K374-29		- -	85310	89423
		K374-32		- -	85310	89423
	All with Air Glide 200 with 40,000 lb Suspension with 8 air bags, 4 units required	665903		- -	85900	...
		665944		- -	85900	...
		70701		- -	85900	...
		665906		- -	85902	...
	Models with Multiple Leaf Springs on Front Axle	B71-1003	○ ○	83312	89409	
		K374-3	○ ○	83312	89409	
		K374-33	○ ○	83312	89409	
	Models with Taper Leaf Springs on Front Axle	B71-1002	○ ○	85001	89410	
		K374-16	○ ○	85001	89410	
		K374-26	○ ○	85001	89410	
		K374-27	○ ○	85001	89410	
	Models with Torsion Bar Bogey (2 rear axles) and KW Air Ride Suspension (with 4 air bags)	K374-28		○ ○	85314	89425
		K374-4		○ ○	85314	89425

APPLICATION GUIDE - TRUCKS, TRAILERS, AND BUSES

Year Año Année	Model Modelo Modèle	OEM #	Front		Rear	
			 Fleetline	 GasSLX	 Fleetline	 GasSLX

KENWORTH(Cont'd.)





T440(Cont'd.)

12 - 17	Models with 12,000 to 20,000 lb Taperleaf Front Suspension	665858 B71-1001	○ ○	85070	89459	
			○ ○	85070	89459	
12 - 17	Models with 21,000 to 23,000 lb Reyco Spring Suspension	19495-01 TK19679		○ ○	83126	89440
				○ ○	83126	89440
12 - 17	Models with Air Glide 380 (AG380) Rear Air Suspension	C71-1002 C71-1016 C71-6015		○ ○	85067	89451
				○ ○	85067	89451
				○ ○	85067	89451
12 - 17	Models with Air Glide 400 (AG400) Rear Air Suspension	671962 C71-1014		○ -	85936	89456
				○ -	85936	89456
12 - 17	Models with Air Glide 400L (AG400L) Rear Air Suspension	C71-1011 C71-1017		- ○	85069	89455
				- ○	85069	89455
12 - 17	Models with Air Glide 460 (AG460) Rear Air Suspension	671963 C71-1015 C71-1015 PLUS		○ -	85937	...
				○ -	85937	...
				○ -	85937	...
12 - 17	Models with Chalmers 40,000 lb Rear Suspension	665174		○ ○	85060	...
12 - 17	Models with Hendrickson HAS - 230 Rear Air Suspension	60670-005		○ ○	83137	...
12 - 17	Models with Hendrickson HMX 400/460 Haulmax - with 16.5" Saddle - with 17.5" & 18.5" Saddle	60680-004 60680-005		○ -	83143	...
				○ -	83142	...
12 - 17	Models with Hendrickson Primaax 230, 460 and 690 Air Suspension (8-1/2" to 10" Ride Height)	60657-003		○ ○	85072	...
12 - 17	Models with Hendrickson Primaax EX 232, 462 and 692 Air Suspension (8-1/2" to 10" Ride Height)	60657-003		○ ○	85072	...
12 - 17	Models with Hendrickson Primaax EX 262S or 522S Rear Air Suspension (10" Ride Height)	60665-011		○ ○	85967	...
12 - 16	Models with Neway AD-123 or AD-246 Models Air Suspension with - Shock stamping	90045068 90045099 90045132		- ○	...	89441
				○ ○	85906	89407
				○ ○	85909	...
12 - 17	Models with Neway ADZ Rear Suspension	471700004423 90045605		○ ○	85109	...
				○ ○	85109	...
12 - 17	Models with Reyco 102 or 79KB Suspension (Drive Axle)	16725-01		○ ○	83221	...

T470

10 - 17	Models with 12,000 to 20,000 lb Taperleaf Front Suspension	665858 B71-1001	○ ○	85070	89459	
			○ ○	85070	89459	
10 - 17	Models with 21,000 to 23,000 lb Reyco Spring Suspension	19495-01 TK19679		○ ○	83126	89440
				○ ○	83126	89440
10 - 16	Models with Air Glide 230 (AG230) Rear Air Suspension	671656 C71-1013		○ -	85985	...
				○ -	85985	...
10 - 17	Models with Air Glide 380 (AG380) Rear Air Suspension	C71-1002 C71-1016 C71-6015		○ ○	85067	89451
				○ ○	85067	89451
				○ ○	85067	89451
10 - 17	Models with Air Glide 400 (AG400) Rear Air Suspension	671962 C71-1014		○ -	85936	89456
				○ -	85936	89456
12 - 17	Models with Air Glide 400L (AG400L) Rear Air Suspension	C71-1011 C71-1017		- ○	85069	89455
				- ○	85069	89455
10 - 17	Models with Air Glide 460 (AG460) Rear Air Suspension	671963 C71-1015 C71-1015 PLUS		○ -	85937	...
				○ -	85937	...
				○ -	85937	...
10 - 16	Models with Chalmers 40,000 lb Rear Suspension	665174		○ ○	85060	...
10 - 16	Models with Hendrickson HAS - 230 Rear Air Suspension	60670-005		○ ○	83137	...

APPLICATION GUIDE - TRUCKS, TRAILERS, AND BUSES

Year Año Année	Model Modelo Modèle	OEM #	Front		Rear	
						
			Fleetline	GasSLX	Fleetline	GasSLX

KENWORTH(Cont'd.)

T470(Cont'd.)

10 - 17	Models with Hendrickson HMX 400/460 Haulmax - with 16.5" Saddle	60680-004		01-	83143	...
	- with 17.5" & 18.5" Saddle	60680-005		01-	83142	...
10 - 17	Models with Hendrickson Primaax 230, 460 and 690 Air Suspension (8-1/2" to 10" Ride Height)	60657-003		010	85072	...
10 - 17	Models with Hendrickson Primaax EX 232, 462 and 692 Air Suspension (8-1/2" to 10" Ride Height)	60657-003		010	85072	...
10 - 16	Models with Neway AD-123 or AD-246 Models Air Suspension with - Shock stamping	90045068		-10	...	89441
		90045099		010	85906	89407
		90045132		010	85909	...
10 - 17	Models with Neway ADZ Rear Suspension	471700004423		010	85109	...
		90045605		010	85109	...
10 - 17	Models with Reyco 102 or 79KB Suspension (Drive Axle)	16725-01		010	83221	...





T600, T600A, T600B, T602

	All with Air Glide 100 Suspension with 8 air bags, 4 units required	K374-29		-1-	85310	89423
		K374-32		-1-	85310	89423
	All with Air Glide 200 with 40,000 lb Suspension with 8 air bags, 4 units required	665903		-1-	85900	...
		665944		-1-	85900	...
		70701		-1-	85900	...
	All with Air Glide 200 with 46,000 lb Suspension with 8 air bags, 4 units required	665906		-1-	85902	...
		665945		-1-	85902	...
06 -	Models with 13,000 lb Front Axle	665858	010	85070	89459	
		B71-1001	010	85070	89459	
01 - 07	Models with Air Glide 380 (AG380) Rear Air Suspension	C71-1002		010	85067	89451
		C71-1016		010	85067	89451
01 - 07	Models with Air Glide 400 (AG400) Rear Air Suspension	671962		01-	85936	89456
		C71-1014		01-	85936	89456
- 07	Models with Air Glide 460 (AG460) Rear Air Suspension	671963		01-	85937	...
	Models with Hendrickson Rear Air Suspension	47902-19		010	83123	89405
		47902-24		010	83137	...
	Models with Multiple Leaf Springs on Front Axle	B71-1003	010	83312	89409	
		K374-3	010	83312	89409	
		K374-33	010	83312	89409	
	Models with Reyco 102 or 79KB Suspension (Drive Axle)	16725-01		010	83221	...
	Models with Reyco 1209 or 1212 Suspension (Steer Axle)	19495-01	010	83126	89440	
	Models with Taper Leaf Springs on Front Axle	B71-1002	010	85001	89410	
		K374-16	010	85001	89410	
		K374-26	010	85001	89410	
		K374-27	010	85001	89410	

T660

	Carhauler with O.E.M. Number	K374-36	010	...	89432	
06 - 17	Models with 12,000 or 13,200 lb Front Axle	665858	010	85070	89459	
		B71-1001	010	85070	89459	
08 - 17	Models with 40,000 lb Low Air leaf Suspension	C71-1011		-1-	85069	89455
		C71-1017		-1-	85069	89455
06 -	Models with Air Glide 230 (AG230) Rear Air Suspension	671656		01-	85985	...
		C71-1013		01-	85985	...
08 - 17	Models with Air Glide 380 (AG380) Rear Air Suspension	C71-1002		010	85067	89451

APPLICATION GUIDE - TRUCKS, TRAILERS, AND BUSES

Year Año Année	Model Modelo Modèle	OEM #	Front			Rear		
								
						Fleetline	GasSLX	Fleetline

KENWORTH(Cont'd.)

T660(Cont'd.)

08 - 17	Models with Air Glide 380 (AG380) Rear Air Suspension	C71-1016 C71-6015		0 0	85067	89451
				0 0	85067	89451
13 - 17	Models with Air Glide 400 (AG400) Rear Air Suspension	671962 C71-1014		0 -	85936	89456
				0 -	85936	89456
13 - 17	Models with O.E.M. Number	B71-6012	0 0	85119

T680

13 - 14	Models with 10,000 lb to 13,200 lb Front Axle	B71-6005	0 0	85084	89460	
14 - 17	Models with 10,000 lb to 14,600 lb Taperleaf Springs and Set Back Front Axles	B71-6019	0 0	85989
14 - 17	Models with 16,000 lb to 20,000 lb Taperleaf Springs and Set Back Front Axles	B71-6020	0 0	85989
13 - 17	Models with 21,000 to 23,000 lb Reyco Spring Suspension	19495-01 TK19679		0 0	83126	89440
				0 0	83126	89440
13 - 17	Models with Air Glide 380 (AG380) Rear Air Suspension	C71-1002 C71-1016 C71-6015		0 0	85067	89451
				0 0	85067	89451
				0 0	85067	89451
13 - 17	Models with Air Glide 400 (AG400) Rear Air Suspension	671962 C71-1014		0 -	85936	89456
				0 -	85936	89456
13 - 17	Models with Air Glide 400L (AG400L) Rear Air Suspension	C71-1011 C71-1017		- -	85069	89455
				- -	85069	89455
13 - 17	Models with Air Glide 460 (AG460) Rear Air Suspension	671963 C71-1015 C71-1015 PLUS		0 -	85937	...
				0 -	85937	...
				0 -	85937	...
13 - 17	Models with Hendrickson HMX 400/460 Haulmax - with 16.5" Saddle - with 17.5" & 18.5" Saddle	60680-004 60680-005		0 -	83143	...
				0 -	83142	...
13 - 17	Models with Hendrickson Primaax EX 462 Air Suspensions Standard with 12 1/2" - 14 3/8" - 15 1/2" Ride Height Standard with 8 1/2" to 10" Ride Height	60665-011 60657-003		0 0	85967	...
				0 0	85072	...
13 - 17	Models with Neway ADZ Rear Suspension	471700004423 90045605		0 0	85109	...
				0 0	85109	...
13 - 17	Models with O.E.M. Number	B71-6012	0 0	85119
13 - 17	Models with Reyco 102 or 79KB Suspension (Drive Axle)	16725-01		0 0	83221	...





T700

11 - 17	Models with 13,000 lb Front Axle	665858 B71-1001		0 0	85070	89459	
				0 0	85070	89459	
11 - 16	Models with Air Glide 230 (AG230) Rear Air Suspension	671656 C71-1013		0 -	85985	...	
				0 -	85985	...	
11 - 17	Models with Air Glide 380 (AG380) Rear Air Suspension	C71-1002 C71-1016 C71-6015		0 0	85067	89451	
				0 0	85067	89451	
				0 0	85067	89451	
11 - 17	Models with Air Glide 400 (AG400) Rear Air Suspension	671962 C71-1014		0 -	85936	89456	
				0 -	85936	89456	

T800, T800B, T800B(8x4), T800SH, T800H, T800W

	All with Air Glide 100 Suspension with 8 air bags, 4 units required	K374-29 K374-32		- -	85310	89423
				- -	85310	89423
	All with Air Glide 200 with 40,000 lb Suspension with 8 air bags, 4 units required	665903 665944 70701		- -	85900	...
				- -	85900	...
				- -	85900	...
	All with Air Glide 200 with 46,000 lb Suspension with 8 air bags, 4 units required	665906		- -	85902	...

APPLICATION GUIDE - TRUCKS, TRAILERS, AND BUSES

Year Año Année	Model Modelo Modèle	OEM #	Front		Rear	
						
			Fleetline	GasSLX	Fleetline	GasSLX

KENWORTH(Cont'd.)





T800, T800B, T800B(8x4), T800SH, T800H, T800W(Cont'd.)

	All with Air Glide 200 with 46,000 lb Suspension with 8 air bags, 4 units required	665945		- -	85902	...
05 - 17	Models with 12,000 to 20,000 lb Front Axles	665858	o o	85070	89459	
		B71-1001	o o	85070	89459	
06 -	Models with Air Glide 230 (AG230) Rear Air Suspension	671656		o -	85985	...
		C71-1013		o -	85985	...
01 - 17	Models with Air Glide 380 (AG380) Rear Air Suspension	C71-1002		o o	85067	89451
		C71-1016		o o	85067	89451
		C71-6015		o o	85067	89451
07 - 17	Models with Air Glide 400 (AG400) Rear Air Suspension	671962		o -	85936	89456
		C71-1014		o -	85936	89456
14 - 17	Models with Air Glide 400L (AG400L) Rear Air Suspension	C71-1017		- -	85069	89455
07 - 17	Models with Air Glide 460 (AG460) Rear Air Suspension	671963		o -	85937	...
		C71-1015		o -	85937	...
		C71-1015 PLUS		o -	85937	...
- 14	Models with Chalmers 40,000 lb Rear Suspension	665174		o o	85060	...
10 - 17	Models with Hendrickson Primaax EX 232, 462 and 692 Air Suspension (8-1/2" to 10" Ride Height)	60657-003		o o	85072	...
				o o	83123	89405
	Models with Hendrickson Rear Air Suspension	47902-19 47902-24		o o	83137	...
	Models with Multiple Leaf Springs on Front Axle	B71-1003	o o	83312	89409	
		K374-3	o o	83312	89409	
		K374-33	o o	83312	89409	
- 17	Models with Neway ADZ Rear Suspension	471700004423		o o	85109	...
		90045605		o o	85109	...
	Models with Neway Rear Air Suspension	90044089		o o	83124	89407
	Models with Neway Rear Air Suspension (AD123-, AD246-)	90045132		o o	85909	...
	Models with Reyco 102 or 79KB Suspension (Drive Axle)	16725-01		o o	83221	...
	Models with Reyco 1209 or 1212 Suspension (Steer Axle)	19495-01	o o	83126	89440	
	Models with Taper Leaf Springs on Front Axle	B71-1002	o o	85001	89410	
		K374-16	o o	85001	89410	
		K374-26	o o	85001	89410	
		K374-27	o o	85001	89410	
	Models with Torsion Bar Bogey (2 rear axles) and KW Air Ride Suspension (with 4 air bags)	K374-28		o o	85314	89425
		K374-4		o o	85314	89425

T880

14 - 17	Models with 10,000 lb to 14,600 lb Taperleaf Springs and Set Back Front Axles	B71-6019	o o	85989
14 - 17	Models with 16,000 lb to 20,000 lb Taperleaf Springs and Set Back Front Axles	B71-6020	o o	85989
14 - 17	Models with Air Glide 400 (AG400) Rear Air Suspension	671962		o -	85936	89456
		C71-1014		o -	85936	89456
14 - 17	Models with Air Glide 400L (AG400L) Rear Air Suspension	C71-1017		- -	85069	89455
14 - 17	Models with Air Glide 460 (AG460) Rear Air Suspension	671963		o -	85937	...
		C71-1015		o -	85937	...
		C71-1015 PLUS		o -	85937	...
14 - 17	Models with Hendrickson HMX 400/460 Haulmax - with 16.5" Saddle - with 17.5" & 18.5" Saddle	60680-004		o -	83143	...
		60680-005		o -	83142	...
14 - 17	Models with Hendrickson Primaax EX 462 Air Suspensions Standard with 12 1/2" - 14 3/8" - 15 1/2" Ride Height Standard with 8 1/2" to 10" Ride Height	60665-011		o o	85967	...
		60657-003		o o	85072	...

APPLICATION GUIDE - TRUCKS, TRAILERS, AND BUSES

Year Año Année	Model Modelo Modèle	OEM #	Front			Rear		
							Fleetline	GasSLX

KENWORTH(Cont'd.)

T880(Cont'd.)

14 - 17	Models with Neway ADZ Rear Suspension	47170004423		○ ○	85109	...
		90045605		○ ○	85109	...
	Models with O.E.M. Number	C71-1015A		○ -	85937	...
14 - 16	Models with O.E.M. Number	B71-6012	○ ○	85119
14 - 17	Models with Reyco 102 or 79KB Suspension (Drive Axle)	16725-01		○ ○	83221	...





T2000

	All with Air Glide 100 Suspension with 8 air bags, 4 units required	K374-29		- -	85310	89423
		K374-32		- -	85310	89423
	All with Air Glide 200 with 40,000 lb Suspension with 8 air bags, 4 units required	665903		- -	85900	...
		665944		- -	85900	...
		70701		- -	85900	...
	All with Air Glide 200 with 46,000 lb Suspension with 8 air bags, 4 units required	665906		- -	85902	...
		665945		- -	85902	...
06 - 10	Models with 13,000 lb Front Axle	665858	○ ○	85070	89459	
		B71-1001	○ ○	85070	89459	
01 - 11	Models with Air Glide 380 (AG380) Rear Air Suspension	C71-1002		○ ○	85067	89451
		C71-1016		○ ○	85067	89451
05 - 11	Models with Air Glide 400 (AG400) Rear Air Suspension	671962		○ -	85936	89456
		C71-1014		○ -	85936	89456
05 - 11	Models with Air Glide 460 (AG460) Rear Air Suspension	671963		○ -	85937	...
				○ -	85937	...
	Models with Multiple Leaf Springs on Front Axle	B71-1003	○ ○	83312	89409	
		K374-3	○ ○	83312	89409	
		K374-33	○ ○	83312	89409	
	Models with Taper Leaf Springs on Front Axle	B71-1002	○ ○	85001	89410	
		K374-16	○ ○	85001	89410	
		K374-26	○ ○	85001	89410	
		K374-27	○ ○	85001	89410	

W900, W900B, W900L, W900S

	All with Air Glide 100 Suspension with 8 air bags, 4 units required	K374-29		- -	85310	89423
		K374-32		- -	85310	89423
	All with Air Glide 200 with 40,000 lb Suspension with 8 air bags, 4 units required	665903		- -	85900	...
		665944		- -	85900	...
		70701		- -	85900	...
	All with Air Glide 200 with 46,000 lb Suspension with 8 air bags, 4 units required	665906		- -	85902	...
		665945		- -	85902	...
	Carhauler with O.E.M. Number	K374-36	○ ○	...	89432	
05 - 17	Models with 12,000 or 13,200 lb Front Axle	665858	○ ○	85070	89459	
		B71-1001	○ ○	85070	89459	
10	Models with 46,000 lb Neway Rear Air Suspension	90045132		○ ○	85909	...
06 -	Models with Air Glide 230 (AG230) Rear Air Suspension	671656		○ -	85985	...
		C71-1013		○ -	85985	...
01 - 17	Models with Air Glide 380 (AG380) Rear Air Suspension	C71-1002		○ ○	85067	89451
		C71-1016		○ ○	85067	89451
		C71-6015		○ ○	85067	89451
05 - 17	Models with Air Glide 400 (AG400) Rear Air Suspension	671962		○ -	85936	89456
		C71-1014		○ -	85936	89456
08 - 17	Models with Air Glide 400L (AG400L) Rear Air Suspension	C71-1011		- -	85069	89455

APPLICATION GUIDE - TRUCKS, TRAILERS, AND BUSES

Year Año Année	Model Modelo Modèle	OEM #	Front		Rear	
						
			Fleetline	GasSLX	Fleetline	GasSLX

KENWORTH(Cont'd.)





W900, W900B, W900L, W900S(Cont'd.)

08 - 17	Models with Air Glide 400L (AG400L) Rear Air Suspension	C71-1017		- -	85069	89455
05 - 17	Models with Air Glide 460 (AG460) Rear Air Suspension	671963		0 -	85937	...
		C71-1015		0 -	85937	...
		C71-1015 PLUS		0 -	85937	...
	Models with Hendrickson Rear Air Suspension	47902-19		0 0	83123	89405
		47902-24		0 0	83137	...
	Models with Multiple Leaf Springs on Front Axle	B71-1003	0 0	83312	89409	
		K374-3	0 0	83312	89409	
		K374-33	0 0	83312	89409	
- 17	Models with Neway ADZ Rear Suspension	471700004423		0 0	85109	...
		90045605		0 0	85109	...
	Models with Reyco 102 or 79KB Suspension (Drive Axle)	16725-01		0 0	83221	...
	Models with Reyco 1209 or 1212 Suspension (Steer Axle)	19495-01	0 0	83126	89440	
- 17	Models with Taper Leaf Springs on Front Axle	B71-1002	0 0	85001	89410	
		K374-16	0 0	85001	89410	
		K374-26	0 0	85001	89410	
		K374-27	0 0	85001	89410	
	Models with Torsion Bar Bogey (2 rear axles) and KW Air Ride Suspension (with 4 air bags)	K374-28		0 0	85314	89425
		K374-4		0 0	85314	89425

Additional O.E.M. Interchanges

	Models with Hendrickson Primaax 260 or 520 Rear Air Suspension (10" Ride Height-Disc Brakes only)	60665-015		0 0	85966	...
	Models with Hendrickson Primaax 260 or 520 Rear Air Suspension (10" Ride Height-Drum Brakes only)	60665-013		0 0	85965	...
	Models with Hendrickson Primaax EX 262 or 522 Rear Air Suspension (10" Ride Height)	60665-013		0 0	85965	...
	Models with Hendrickson Primaax EX 262S or 522S Rear Air Suspension (10" Ride Height)	60665-011		0 0	85967	...
	OE PLUS Shock Stamping Number	02-02736PLUS	0 0	85302	89420	
		02-02737PLUS	0 0	85062	89408	
		02-02738PLUS	0 0	85012	89413	
		02-02739PLUS	0 0	85013	89414	
		03-04176PLUS		0 0	85308	89422
		03-06084PLUS		- 0	85033	89427
		03-07421PLUS		- 0	85311	89424
		03-07423PLUS		- 0	85033	89427
		10-12032-002PLUS	0 0	85320	89429	
		10-12542-000PLUS	0 0	85901
		16-13947-000PLUS		- 0	85319	89428
		2018987C1PLUS		0 0	85003	89411
		47902-13PLUS		0 0	83122	89406
		60670-005PLUS		0 0	83137	...
		60670-008PLUS		0 0	83123	89405
		665565PLUS		0 0	85007	89412
		671962PLUS		0 -	85936	89456
		70701PLUS		- -	85900	...
		8086053PLUS		0 0	85047	89435
		90044025PLUS	0 0	83209	89414	
		90044089PLUS	0 0	0 0	83124	89407
		B71-6015	0 0	85012	89413	
		C71-1002PLUS		0 0	85067	89451
C71-1011PLUS		- -	85069	89455		

APPLICATION GUIDE - TRUCKS, TRAILERS, AND BUSES









Year Año Année	Model Modelo Modèle	OEM #	Front		Rear	
						
			Fleetline	GasSLX	Fleetline	GasSLX

KENWORTH(Cont'd.)

Additional O.E.M. Interchanges(Cont'd.)

	OE PLUS Shock Stamping Number	K374-26PLUS	010	85001	89410	
		K374-28PLUS		010	85314	89425
		K374-29PLUS		-1-	85310	89423
		K374-33PLUS	010	83312	89409	
	TruckMaster Shock Stamping Number	665632	010	85013	89414	
		665633		-10	85033	89427
		665783		010	83123	89405
		665784		010	83122	89406
		665785		010	83137	...
		665844		-1-	85069	89455
		665918		-1-	85900	...
		665926		010	85047	89435
		665927	010	85901
		665928	010	85062	89408	
		665930	010	85001	89410	
		665931	010	83312	89409	
		665932	010	85012	89413	
		665950		-1-	85902	...
		671052	010	85070	89459	
		671654		01-	85936	89456
		671699		01-	85937	...
		671794		010	85067	89451
		680237		85303	...	010	85303	89422
		680239		-1-	85310	89423
		680240		010	85302	89420
		680242		010	85308	89422
		680253		010	85314	89425
		680261	010	85062	89408	
		680279	010	83209	89414	
		680280		010	85906	89407
		680281		010	85003	89411
		680283	01-	83353
		680303		010	85007	89412
		680425	010	85320	89429	
		680435		-10	85033	89427
		680473		-10	85319	89428
	All with Air Glide 100 Suspension with 8 air bags, 4 units required	K374-C7		-1-	85310	89423
	Models with Multiple Leaf Springs on Front Axle	K374-14	010	83312	89409	
		K374-5	010	83312	89409	
	Models with O.E.M. Number	665453	010	85001	89410	
		665670	010	85001	89410	
		665680	010	83312	89409	
		665788		010	85000	89436
		665828		010	85067	89451
		675041	01-	83353
		675122	010	85001	89410	
		680241		-10	85311	89424
		680475		010	85314	89425
		680476		-1-	85310	89423
		680486		-1-	85310	89423

APPLICATION GUIDE - TRUCKS, TRAILERS, AND BUSES

Year Año Année	Model Modelo Modèle	OEM #	Front		Rear	
						
						
			Fleetline	GasSLX	Fleetline	GasSLX

KENWORTH(Cont'd.)

Additional O.E.M. Interchanges(Cont'd.)

Models with O.E.M. Number	680586		-10	85311	89424	
	B71-6000	010	85959	
	B71-6002	010	85012	89413		
	B71-6003	010	85029	
	B71-6007	010	85062	89408		
	B71-6008	010	83312	89409		
	B71-6010	010	85023 or 89415					
	B71-6011	010	85062	89408		
	B71-6013	010	85012	89413		
	B71-6016	010	85012	89413		
	B71-6017	010	85910	
	B71-6018	010	85012	89413		
	C71-6003		-10	85988	...	
	C71-6004		-10	85343	...	
	C71-6005		-1-	85069	89455	
	K374-15	01-	83353	
	K374-7		-1-	85310	89423	
	K374-9		-1-	85310	89423	
	K374-C31	010	83312	89409		
	R71-6006	010	83063					
	R71-6007	010	83008					
	R71-6008	010	83035					
	S-20126		010	85323	89436	
	Models with Taper Leaf Springs on Front Axle	K374-11	010	85001	89410	
	Additional O.E.M. Interchanges	3166657	010	85700				
665092		010	83312 or 89409					
665118		010	83312 or 89409					
K374-10		010	83362					
K374-3-1		010	83312 or 89409					

KENWORTH CAB SHOCKS

Aerocab

	Models with 38" Sleepers with Link Cabmate Models KWK1T03 or KWCSA 01-06	1202-1264	010	83031
	Models with 62" and 74" Sleepers with O.E.M. Number	1202-1164	010	83031
	Models with 72" Sleepers with Link Cabmate Models KWK1T02 or KWCSA 01-06	1202-1065	010	83002
08 - 16	Models with 86" Sleepers with O.E.M. Number	1202-1286	010	83056
		1202K286	010	83056
		T71-1003	010	83056

C-500B

	Models with Link Cabmate KWB500 Air Suspension	1202-0044	010	83025
--	--	-----------	-----	-------





COE Models

	90" and 112" E Models with Link Cabmate KWE90112-B Air Suspension	1202K064	010	83024
		R71-1005	010	83024
	Models with Link Cabmate KW1102-B Air Suspension (Does not fit Non-Sleeper cabs)	1202-0032	010	83016
	Models with Link Cabmate KWE90112-A Air Suspension	1202-0032	010	83016

ICON 900

2016	Models with 86" Sleepers with O.E.M. Number	T71-1003	010	83056
2016	Models with O.E.M. Number	T71-1002	010	83002

APPLICATION GUIDE - TRUCKS, TRAILERS, AND BUSES

Year Año Année	Model Modelo Modèle	OEM #	Front		Rear	
						
			Fleetline	GasSLX	Fleetline	GasSLX

KENWORTH CAB SHOCKS(Cont'd.)

T400A(Cont'd.)

06/92 -	Models with Link Cabmate Air Suspension KWB689-A with rear cab support Kenworth P/N K235-1646	1202-0012	010	83023
- 05/92	Models with Link Cabmate KWB400-A Air Suspension	1202-0012	010	83023
05/92 -	Models with Link Cabmate KWB689-B or KWB689-C Air Suspension	1201-1043	010	83025
06/92 -	Models with Link Cabmate KWB689-B or KWB689-C Air Suspension	1202-1043	010	83025

T440

	Models with Link Cabmate KWB689-D and Severe service crossmembers	1201-1046	010	83049
		1202-1046	010	83049
		1202K046	010	83049
		R71-1004	010	83049

T450

06/92 -	Models with Link Cabmate Air Suspension KWB689-A with rear cab support Kenworth P/N K235-1646	1202-0012	010	83023
- 05/92	Models with Link Cabmate KWB400-A Air Suspension	1202-0012	010	83023
05/92 -	Models with Link Cabmate KWB689-B or KWB689-C Air Suspension	1201-1043	010	83025
06/92 -	Models with Link Cabmate KWB689-B or KWB689-C Air Suspension	1202-1043	010	83025
	Models with Link Cabmate KWB689-D and Severe service crossmembers	1202K046	010	83049
		R71-1004	010	83049

T600

	Models with Link Cabmate KWMC642 Air Suspension	1202-0054	010	83021
--	---	-----------	-----	-------

T600A

	Models with Link Cabmate KWB689-A Air Suspension and rear cab mount Kenworth P/N K235-1436 or K235-1488	1202-0012	010	83023
	Models with Link Cabmate KWB689-B or KWB689-C Air Suspension and rear cab mount Kenworth part # K235-1436 or K235-1488	1201-1043	010	83025
		1202-1043	010	83025
	Models with Link Cabmate KWB689-D and Severe service crossmembers	1202K046	010	83049
		R71-1004	010	83049

T660

08 - 17	Models with 86" Sleepers with O.E.M. Number	1202-1286	010	83056
		1202K286	010	83056
		T71-1003	010	83056
06 - 10	Models with Link Cab Suspension	1202-1065	010	83002





T700

11 - 16	DayCab Models with O.E.M. Number	R71-6000	010	83067
		R71-6010	010	83067
08 - 16	Models with 86" Sleepers with O.E.M. Number	1202-1286	010	83056
		1202K286	010	83056
		T71-1003	010	83056
11 - 16	Models with Extended Sleeper Cab	1202-1064	010	83024
		1202K064	010	83024
		R71-1005	010	83024

T800 / T800A

- 12	Models with Link Cab Suspension	1202-1046	010	83049
	Models with Link Cabmate KWB689-A Air Suspension and rear cab mount Kenworth P/N K235-1436 or K235-1488	1202-0012	010	83023

APPLICATION GUIDE - TRUCKS, TRAILERS, AND BUSES

Year Año Année	Model Modelo Modèle	OEM #	Front		Rear	
						
			Fleetline	GasSLX	Fleetline	GasSLX

KENWORTH CAB SHOCKS(Cont'd.)

T800 / T800A(Cont'd.)

	Models with Link Cabmate KWB689-B or KWB689-C Air Suspension and rear cab mount Kenworth part # K235-1436 or K235-1488	1201-1043	010	83025
		1202-1043	010	83025
	Models with Link Cabmate KWB689-D and Severe service crossmembers	1202K046	010	83049
- 14	Models with Link Cabmate KWB689-D and Severe service crossmembers	R71-1004	010	83049
	Models with Link Cabmate KWMC642 Air Suspension	1202-0054	010	83021

W900L

06 - 17	Models with O.E.M. Number	1202K065	010	83002
		T71-1002	010	83002

T2000

97 - 10	Models with Link Cabmate KWT2000-A Air Suspension	1202-1064	010	83024
		1202K064	010	83024
		R71-1005	010	83024
07/98 -	Models with PowerPacker Cab Suspension after 6/28/98	PP2582870	010	83012
- 06/98	Models with PowerPacker Cab Suspension prior to 6/28/98	96027-10545	010	83011

W-900 / W-900B

	Models with Link Cabmate KWB689-A Air Suspension and rear cab mount Kenworth P/N K235-1436 or K235-1488	1202-0012	010	83023
	Models with Link Cabmate KWB689-B or KWB689-C Air Suspension and rear cab mount Kenworth part # K235-1436 or K235-1488	1201-1043	010	83025
		1202-1043	010	83025
	Models with Link Cabmate KWB689-D and Severe service crossmembers	1202K046	010	83049
		R71-1004	010	83049
	Models with Link Cabmate KWMC642 Air Suspension	1202-0054	010	83021

Additional Applications

	60" Sleeper with Link Cab Suspension	1202-0043	010	83032
- 82	Conventional Tractors with A-Model cabs & Link Cabmate Model KWA900	1201-0012	010	83023
		1202-0012	010	83023
86 -	Kenworth Sleepers with Link Cabmate KWS60-A Air Suspension and round cornered doors.	1201-1044	010	83025
	Models with Link Cab Suspension	1202-0022	010	83046
		1202-0042	010	83025
	Models with O.E.M. Number	1202-K065	010	83002
		1202K164	010	83031
		1202K264	010	83031
		PP1058870	010	83059
		R71-6005	010	83042
		T71-1000	010	83031
		T71-1001	010	83031

KIMBLE MIXER CO





	Rear Discharge Mixers with Self - Steering Axle Shock	T91-00002-00		010
--	---	--------------	--	-----	-----	-----	-----	-----

KING OF THE ROAD

Class A MotorHomes

04 - 06	Genesis Series MotorHomes with Freightliner XC Chassis ADL200 Suspension w/ 20K Rear AS120 Front Suspension	16-16873-000 141700131810						
			010	83160	...	010	85029	...

APPLICATION GUIDE - TRUCKS, TRAILERS, AND BUSES

Year Año Année	Model Modelo Modèle	OEM #	Front		Rear	
						
			Fleetline	GasSLX	Fleetline	GasSLX

KING OF THE ROAD(Cont'd.)

Class A MotorHomes(Cont'd.)

04 - 06	ADL200 Suspension w/ 20K Rear	16-16737-000	0 0	83160
		16-16874-000	0 0	83160
	Rear Shock with O.E.M. Number	141700131809		0 0	85029	...
		16-16736-000		0 0	85029	...
	ZF - IFS Front Suspension with 23,000 lb GVW or Greater	16-18103-000	- -	85900
		481700000493	- -	85900

KWK-LOC (JIFFLOX)

	Truck Dolly	CP-5222	0 0	85315
--	-------------	---------	-----	-------	-----	--	-----	-----





LEYLAND TRUCK

	Models with Air Trac Suspension (38000 or 40000 lb)	1456033		- 0	85311	89424
--	---	---------	--	-----	-----	-----	-------	-------

LINK MANUFACTURING CAB SHOCKS

	Models with Link Cab Suspension	1202-1046	0 0				83049	
06 - 13	Peterbilt 335 Day Cab models with Link Number	1202P055	0 0				83061	
	Models with Link Cab Suspension	1201-0012	0 0				83023	
		1201-0154	0 0				83051	
		1201-0254	0 0				83051	
		1201-1043	0 0				83025	
		1201-1044	0 0				83025	
		1201-1046	0 0				83049	
		1201-1049	0 0				83025	
		1201-1212	0 0				83013	
		1201-1213	0 -				83005	
		1201-9001	0 0				83052	
		1201-9002	0 0				83052	
		1201-9003	0 0				83052	
		1201-9007	0 0				83054	
		1201-9008	0 0				83054	
		1201-9009	0 0				83054	
		1201-9010	0 0				83053	
		1201-9011	0 0				83053	
		1201-9013	0 -				83062	
		1201-9014	0 -				83062	
		1201-9018	0 -				83062	
		1201-9021	0 -				83062	
		1202-0012	0 0				83023	
		1202-0022	0 0				83046	
		1202-0032	0 0				83016	
		1202-0042	0 0				83025	
		1202-0043	0 0				83032	
		1202-0044	0 0				83025	
		1202-0052	0 0				83021	
		1202-0054	0 0				83021	
		1202-1042	0 0				83025	
		1202-1043	0 0				83025	
		1202-1044	0 0				83025	
		1202-1064	0 0				83024	
		1202-1065	0 0				83002	
		1202-1164	0 0				83031	

APPLICATION GUIDE - TRUCKS, TRAILERS, AND BUSES

Year Año Année	Model Modelo Modèle	OEM #	Front		Rear	
						
			Fleetline	GasSLX	Fleetline	GasSLX

LINK MANUFACTURING CAB SHOCKS(Cont'd.)

Models with Link Cab Suspension	1202-1212	010	83013
	1202-1213	01-	83005
	1202-1286	010	83056
	1202K065	010	83002
	1202K164	010	83031
	1202K264	010	83031
	1202K286	010	83056
	632120	010	83046
	632129	010	83023
	635705	010	83016
	654669	010	83021
	654799	010	83025
	654811	010	83024
	654833	010	83021
	654847	010	83002
	654849	010	83031
	654867	010	83025
	LG40450	010	83016
	LG40470	010	83016
	R71-1004	010	83049
R71-1005	010	83024	
T71-1000	010	83031	
T71-1001	010	83031	
T71-1002	010	83002	

LINK MANUFACTURING LTD.

(See Specialty App's Section Also)							
	Sterling Models with Link Rear Air Suspension	1210-0528	010	85904	...
	Models with O.E.M. Number	1210-0005	010	85734	...
		671093	010	85904	...

LODAL, INC.

	Refuse Truck	9960257	010	83122	89406
--	--------------	---------	-----	--------------	--------------	-----	-----





M.A.N. BUS

Americana Bus with O.E.M. Numbers	25-1700-106-654	- -	85708	...
	81-43701-6543	- -	85708	...
	81-43701-6572	- -	85708
	81-43701-6573	- -	85722
Articulating Bus - Drive Axle	81-43701-6537	- -	85709	...
Articulating Bus - Front Axle	81-43701-6538	- -	85708
Articulating Bus - Trailing Axle	81-43701-6539	- -	85708	...
Models with O.E.M. Number	134	- -	85709	...
	81-43701-6609	- -	85709	...
	9020M-1042	- -	85709	...

MAC TRAILER MFG., INC.

Identification of the trailer suspension is necessary to determine what section of the catalog to refer to. Some possible options can be Chalmers, Hendrickson, Neway, Ridewell, Reyco.							
---	--	--	--	--	--	--	--

APPLICATION GUIDE - TRUCKS, TRAILERS, AND BUSES

Year Año Année	Model Modelo Modèle	OEM #	Front		Rear	
						
			Fleetline	GasSLX	Fleetline	GasSLX

MACK

CH Series

	CH Models with Hendrickson HA Series Air Suspension	14QK-410M2 14QK-410M3 25625254		OIO	83137	...
	CH600 Models with 12000 lb Taperleaf Spring	14QK-392AM 14QK-392BM 14QK-392BM3 14QK-396M 25625743	OIO	85005	89430	
	CH600 Models with AL Suspension	14QK-393M		OIO	85010	...
	CH600 Models with ALV Hendrickson Suspension	14QK-413M5 14QK-413M6 25622221 25625223		OIO	83138	...
	CH600 Models with HAS400 MACK Air Suspension	14QK-410M 25625234 47902-25		OIO	83125	...
	CH600 Models with Hendrickson AL-405 Rear Suspension	14QK-413M7 25625223 57241-006		OIO	83111	...
	CH600 Models with Hendrickson HN-2 Series Suspension	14QK-415M 14QK-415M7 25624241		OIO	83112	...
	CH600 Models with Hendrickson Rear Air Suspension	14QK-393AM 47902-9		OIO	83123	89405
	CH600 Models with Neway AD Air Suspension Shock w/ extend length of 24.30"	14QK-414M2 25624351		OIO	85909	...
	CH600 Models with ST34 Suspension	14QK-2133M 25622466	OIO	85001	89410	
	CH600 Models with Steering Axle with Parabolic Taperleaf Spring	14QK-396	OIO	85005	89430	
	Models with O.E.M. Number	14QK-2113P6 14QK-421M	OIO	OIO	85007	89412
			OIO	85014





CHN - Series

05 - 07	CHN-613 Models w/ MACK Air Suspension	14QK-3101M 471700000431 SDA471700000431		OIO	85066	89448
05 - 07	CHN-613 Models with 12,000 lb Front Axle	14QK-3107M 20973993	OIO	85061	89450	
05 - 07	CHN-613 Models with 14,600 lb Front Axle	20998401	OIO	85014
05 - 07	CHN-613 Models with Camelback Rear Suspension (SS34 & 38)	25625091		OIO	83215	...

CHU - Pinnacle Series

08 - 17	CHU-613 Models with 12,000 lb or 14,600 lb Front Axle	14QK-434M 20625775 20998401 SDA471700002861	OIO	85014
11 - 17	CHU-613 Models with 40,000 lb Rear Air Suspensions	22202560 471700009647		OIO	85088	...
08 - 14	CHU-613 Models with Hendrickson 38,000 lb Rear Air Suspension	14QK-424M 20570098		OIO	83147	...
				OIO	83147	...

APPLICATION GUIDE - TRUCKS, TRAILERS, AND BUSES

Year Año Année	Model Modelo Modèle	OEM #	Front		Rear	
						
			Fleetline	GasSLX	Fleetline	GasSLX

MACK(Cont'd.)

CHU - Pinnacle Series(Cont'd.)

08 - 14	CHU-613 Models with Hendrickson 38,000 lb Rear Air Suspension	60670-006		010	83147	...
- 17	CHU-613 Models with Hendrickson HAS 400 or 460 Series Rear Suspension	60675-001		010	85978	...
		8083872		010	85978	...
- 15	CHU-613 Models with O.E.M. Number	25625091		010	83215	...

CL Series

	CL600, CL700 Models with Neway AD Air Suspension Shock w/ extend length of 24.30"	14QK-414M2		010	85909	...
		25624351		010	85909	...
	CL600, CL700 Models with ALV Hendrickson Suspension	14QK-413M5		01-	83138	...
		14QK-413M6		01-	83111	...
		25622221		01-	83111	...
		25625223		01-	83111	...
	CL600, CL700 Models with HAS400 MACK Air Suspension	14QK-410M		010	83125	...
		25625234		010	83125	...
		47902-25		010	83125	...
	CL600, CL700 Models with Hendrickson HA Series Air Suspension	14QK-410M2		010	83137	...
		14QK-410M3		010	83125	...
		25625254		010	83125	...
	CL600, CL700 Models with Hendrickson HN-2 Series Suspension	14QK-415M		01-	83112	...
		14QK-415M7		01-	83112	...
		25624241		01-	83112	...
	CL600, CL700 Models with Hendrickson Rear Air Suspension	14QK-393AM		010	83123	89405
		47902-9		010	83123	89405
	CL600, CL700 Models with Multileaf Spring Suspension	14QK-392AM2	010	83123	89405	
		14QK-392BM2	010	85321
	CL600, CL700 Models with ST34 Suspension	14QK-2113	010	85001	89410	
		14QK-2133M	010	85001	89410	
		25621955	010	85001	89410	
		25622466	010	85001	89410	
		25632145	010	85001	89410	
	CL600, CL700 Models with Steering Axle & Taperleaf Spring	14QK-392AM	010	85005	89430	
		14QK-392BM	010	85005	89430	
		25625743	010	85005	89430	

CS, MS - Mid - Liner Series

	CS Models Mid-Liner with O.E.M Number	4103-5000447861	-10	83105
		4103-5000546892	-10	83105
		V10234121	-10	83105
		V10242320	-10	83105
	MS200, MS300 Models Mid-Liner	V10234121	-10	83105





CV - Series

02 - 07	CV-713 Models with 18,000 lb Front Axles	14QK-366	010	85036	89405	
		25625151	010	85036	89405	
02 - 07	CV-713 Models with Hendrickson HN-2 Models Suspension	14QK-415M		01-	83112	...
		14QK-415M7		01-	83112	...
		25624241		01-	83112	...

CX Series - Vision

	CX Vision Models w/ Hendrickson Air Suspension	14QK-431M		010	85061	89450
	CX Vision Models w/ Hendrickson HA Models Air Suspension	14QK-410M2		010	83137	...

APPLICATION GUIDE - TRUCKS, TRAILERS, AND BUSES

Year Año Année	Model Modelo Modèle	OEM #	Front		Rear	
						
			Fleetline	GasSLX	Fleetline	GasSLX

MACK(Cont'd.)

CX Series - Vision(Cont'd.)

	CX Vision Models w/ Hendrickson HA Models Air Suspension	14QK-410M3 25625254		010	83125	...
				010	83125	...
	CX Vision Models w/ Hendrickson HN-2 Models Suspension	14QK-415M 14QK-415M7 25624241		01-	83112	...
				01-	83112	...
				01-	83112	...
	CX Vision Models w/ Neway AD Air Suspension Shock w/ extend length of 24.30"	14QK-414M2 25624351		010	85909	...
				010	85909	...
	CX Vision Models w/ Parabolic Spring	14QK-431M		010	85061	89450
	CX Vision Models w/ ALV Hendrickson Suspension	14QK-413M5 14QK-413M6 25622221 25625223		01-	83138	...
				01-	83111	...
				01-	83111	...
				01-	83111	...
	CX Vision Models w/ MACK Air Suspension	14QK-3101M 471700000431 SDA471700000431		010	85066	89448
				010	85066	89448
				010	85066	89448
	Models with 12000 lb Taperleaf Front Suspension	14QK-392BM3	010	85005	89430	
	Models with HAS400 MACK Air Suspension	14QK-410M 25625234 47902-25		010	83125	...
				010	83125	...
				010	83125	...
	Models with Hendrickson Air Suspension (Stamping No. 57241-4)	14QK-413M4 25624341		01-	83110	...
				01-	83110	...
	Models with MAC AL405 Suspension	14QK-413M7 25625223 57241-006		01-	83111	...
				01-	83111	...
				01-	83111	...
	Models with O.E.M. Number	141700000373 20513881	010	85061	89450	
			010	85061	89450	

CXN Series

05 - 07	CXN-613 Models w/ MACK Air Suspension	14QK-3101M SDA471700000431		010	85066	89448
				010	85066	89448
11 - 14	CXN-613 Models with 12,000 - 14,600 lb Front Axles	141700005839 21436096	010	85098
			010	85098
	CXN-613 Models with 12,000 lb Front Axles	14QK-3114M 20973993 SDA141700000380	010	85061	89450	
			010	85061	89450	
			010	85061	89450	
	CXN-613 Models with 40,000 lb Rear Air Suspensions	14QK-2136M 20897198		010	85061	89450
				010	85061	89450
11 - 14	CXN-613 Models with 40,000 lb Rear Air Suspensions	21462382 471700006039		010	85088	...
				010	85088	...
	CXN-613 Models with Hendrickson AirTek Front Air Suspension	14QK-422M 20485633 64838-002	010	85933	89454	
			010	85933	89454	
			010	85933	89454	





CXP Series

11 - 12	CXP-613 Models with 12,000 - 14,600 lb Front Axles	141700005839 21436096	010	85098
			010	85098
06 - 07	CXP-613 Models with 12,000 lb Front Axles	14QK-3114M 20973993 SDA141700000380	010	85061	89450	
			010	85061	89450	
			010	85061	89450	

CXU - Pinnacle Series

11 - 17	CXU-613 Models with 12,000 - 14,600 lb Front Axles	141700005839	010	85098
----------------	--	--------------	-----	--------------	-----	--	-----	-----

APPLICATION GUIDE - TRUCKS, TRAILERS, AND BUSES

Year Año Année	Model Modelo Modèle	OEM #	Front		Rear	
						
			Fleetline	GasSLX	Fleetline	GasSLX

MACK(Cont'd.)

CXU - Pinnacle Series(Cont'd.)

11 - 17	CXU-613 Models with 12,000 - 14,600 lb Front Axles	21436096	010	85098
08 - 10	CXU-613 Models with 12,000 lb Front Axles	141700000380	010	85061	89450	
		14QK-3114M	010	85061	89450	
		20973993	010	85061	89450	
		SDA141700000380	010	85061	89450	
08 - 10	CXU-613 Models with 40,000 lb Rear Air Suspensions	14QK-2136M		010	85061	89450
		20897198		010	85061	89450
		471700002626		010	85061	89450
11 - 17	CXU-613 Models with 40,000 lb Rear Air Suspensions	21462382		010	85088	...
		21462384		010	85088	...
		22202559		010	85088	...
		22202560		010	85088	...
		471700006039		010	85088	...
		471700009646		010	85088	...
		471700009647		010	85088	...

DM Series

	Models with O.E.M. Number	14QK-2100P8	010	83242
		25622345	010	83242





F Series

	F Models - Eastern	010	83221
	F Models (exc. Eastern)	010	83207	89407	010	83215	...
	F Models with Standard Suspension	010	85305	...
	Fire Truck		85302	...	010	85302	89420
	FL Models - Western	14QK-143	010	83207	89407	
		14QK-2100D-P4	010	83207	89407	

Granite Series - GU-432, GU-533, GU-713, GU-813

12 - 17	GU-432 or GU-533 Models with 12,000 lb or 14,600 lb Front Axle	20998401	010	85014
12 - 17	GU-432 or GU-533 Models with 14,600 lb to 18,000 lb Multi-Leaf Front Springs	21010744	010	83101
12 - 17	GU-432 or GU-533 Models with Hendrickson HAS 400 or 460 Series Rear Suspension	60675-001		010	85978	...
		8083872		010	85978	...
	GU-713 or GU-813 Models O.E.M. Number	21687170	010	85120
08 - 17	GU-713 or GU-813 Models with 14,600 lb to 18,000 lb Multi-Leaf Front Springs	14QK-3116M	010	83101
		21010744	010	83101
08 - 10	GU-713 or GU-813 Models with 20,000 lb Front Axles	14QK-3108M	01-	85080
		14QK-427M	01-	85080
		20863239	01-	85080
		25626048	01-	85080
		471700000445	01-	85080
08 - 15	GU-713 or GU-813 Models with Hendrickson 38,000 lb Rear Air Suspension	14QK-424M		010	83147	...
		20570098		010	83147	...
		60670-006		010	83147	...
08 - 17	GU-713 or GU-813 Models with Hendrickson HAS 400 or 460 Series Rear Suspension	60675-001		010	85978	...
		8083872		010	85978	...
08 - 17	GU-713 or GU-813 Models with Hendrickson HAS Series Rear Suspension	22314111		010	85036	89405
		60675-13		010	85036	89405

APPLICATION GUIDE - TRUCKS, TRAILERS, AND BUSES

Year Año Année	Model Modelo Modèle	OEM #	Front		Rear	
			 Fleetline	 GasSLX	 Fleetline	 GasSLX

MACK(Cont'd.)

LE & LEU Series(Cont'd.)

	LE & LEU 613 Models with Ridewell RD-202S HD Tandem Drive Truck Suspension	1252607B000		010	85702	...
01 - 06	LE 613 Models with O.E.M Number	14QK-366P4	010	83209	89414	
		25625187	010	83209	89414	
2009	LEU 613 Models with 18,000 lb Front Axle	14QK-372M2	010	83209	89414	
		25632561	010	83209	89414	
10 - 16	LEU 613 Models with 20,000 lb Front Axle	21002497	010	85972

MH Series

	MH Models - 4" Wide Springs	14QK-373	010	83215
		14QK-378M	010	83215
		25623321	010	83215
	MH Models with Camelback Rear Suspension (SS34 & 38)	14QK-2107P1		010	83215	...
		14QK-2107P2		010	83215	...
		25625091		010	83215	...
	MH Models with Neway ARD-234 Air Suspension	14QK-375M		010	83123	89405
	MH Models with O.E.M. Number	14QK-2113P5	010	85001	89410	
		14QK-2133M	010	85001	89410	
		14QK-2133M2	010	85001	89410	
		14QK-377M	010	83215
		14QK-392AM		85005	...	010	85005	89430
		25622466	010	85001	89410	
	MH Models with Taperleaf Rear Suspension	14QK-2113P4		010	85007	89412

MR Series

	Models with O.E.M. Number	14QK-3115M	010	85972
		21002497	010	85972





R Series

	R, RU, RD600 Models-3 1/2" Wide springs	14QK-366P1	010	85036	89405	
	R, U Models	010	83221	...	010	83215	...
	R, U, RD 600 Models	14QK-2115	010	85305
		14QK-29302	010	83207	89407	
		25632147	010	85305
	R, U, RD 600 Models/ MR600 Models with Front Taperleaf Springs	14QK-366	010	85036	89405	
		14QK-366P1	010	85036	89405	
		25625151	010	85036	89405	
	RB 600 Models (Drive Axle)	14QK-2107		010	83215	...
		14QK-393M		010	85010	...
	RD Models with ST34 Suspension	14QK-2133M	010	85001	89410	
		25622466	010	85001	89410	
	RD800 Models with Shock Absorbers & Taperleaf Suspension (SWT & SWTL 561)(ST-34)	14QK-2110	010	85305

RW Series

	RW Models - 4" Wide Springs	14QK-373	010	83215
		14QK-378M	010	83215
		25623321	010	83215
	RW Models with Camelback Rear Suspension (SS34 & 38)	14QK-2107P1		010	83215	...
		14QK-2107P2		010	83215	...
		25625091		010	83215	...
	RW Models with Neway ARD-234 Air Suspension	14QK-375M		010	83123	89405
	RW Models with O.E.M. Number	14QK-2113P5	010	85001	89410	
		14QK-2133M	010	85001	89410	
		14QK-2133M2	010	85001	89410	

APPLICATION GUIDE - TRUCKS, TRAILERS, AND BUSES

Year Año Année	Model Modelo Modèle	OEM #	Front		Rear	
						
			Fleetline	GasSLX	Fleetline	GasSLX

MACK(Cont'd.)

RW Series(Cont'd.)

	RW Models with O.E.M. Number	14QK-377M	○ ○	83215
		14QK-392AM		85005	...	○ ○	85005	89430
		25622466	○ ○	85001	89410	
	RW Models with Taperleaf Rear Suspension	14QK-2113P4		○ ○	85007	89412

TD - Titan Series

08 - 10	TD-713 Models with 20,000 lb Front Axle	14QK-493M	○ ○	83101
		21155033	○ ○	83101
10 - 15	TD-713 Models with Hendrickson 38,000 lb Rear Air Suspension	14QK-424M		○ ○	83147	...
		20570098		○ ○	83147	...
		60670-006		○ ○	83147	...
- 16	TD-713 Models with Hendrickson 40,000 lb Pimaax EX and FireMaax EX Air Suspension	20782199		○ ○	85072	...
		60657-007		○ ○	85072	...
- 17	TD-713 Models with Hendrickson HAS 400 or 460 Series Rear Suspension	60675-001		○ ○	85978	...
		8083872		○ ○	85978	...
- 17	TD-713 Models with Hendrickson HAS Series Rear Suspension	22314111		○ ○	85036	89405
		60675-13		○ ○	85036	89405









Additional Applications

	B Models	14QK-142		○ ○	85305	...
	CF Fire Chassis	14QK-2102		○ ○	85304	...
	CM 422 Tractor	14QK-390	- ○	83105
		V10242320	- ○	83105
	DM Models	○ ○	83209	89414	○ ○	83215	...
	MB Models	○ ○	83221	...	○ ○	83215	...
		14QK-2100P4	○ ○	83207	89407	
	Model 75 Bogie Axle	○ ○	83215	...
	Models with 12000 lb Taperleaf Spring	14QK-392AM3	○ ○	85005	89430	
06 - 16	Models with Hendrickson 40,000 lb Primaax, Pimaax EX and FireMaax EX Air Suspension	60657-007		○ ○	85072	...
	Models with Hendrickson AirTek Front Air Suspension	14QK-422M	○ ○	85933	89454	
		20469001	○ ○	85933	89454	
		20469002	○ ○	85933	89454	
		20485632	○ ○	85933	89454	
		20485633	○ ○	85933	89454	
		471700131921	○ ○	85933	89454	
	64838-002	○ ○	85933	89454		
	Models with Hendrickson HAS-40LH Air Suspension (O.E. Number 57241-4)	14QK-413M4		○ -	83110	...
	Models with Inverted Camelback Spring Suspension	14QK-142P1	○ ○	83215
	Models with MAC AL405 Suspension	14QK-413M		○ -	83111	...
	Models with Meritor AirLink Suspension	14QK-3100		○ ○	85739	...
		446-51-211		○ ○	85739	...
	Models with Neway Rear Suspension (With O.E.Stamping 90045099)	14QK-414M		○ ○	85906	89407
		25633154		○ ○	85906	89407
75 - 79	W Models - Western	○ ○	83207	89407	○ ○	83215	...

Additional O.E.M. Interchanges

	Models with O.E.M. Number	14QK-1200P4	○ ○	83207	89407	
		14QK-140	○ ○	85304
		14QK-142AP1	○ ○	83215
		14QK-145	○ ○	85307

APPLICATION GUIDE - TRUCKS, TRAILERS, AND BUSES





Year Año Année	Model Modelo Modèle	OEM #	Front		Rear	
						
						
			Fleetline	GasSLX	Fleetline	GasSLX

MACK(Cont'd.)

Additional O.E.M. Interchanges(Cont'd.)

Models with O.E.M. Number	14QK-2100P2	010	83209	89414	
	14QK-2100P3	010	83207	89407	
	14QK-2100P5	010	83221	
	14QK-2100P6	010	85036	89405	
	14QK-2100P7	010	83221	
	14QK-2105	010	83209	89414	
	14QK-2107P3	010	83215	
	14QK-2108	010	83203	89436	
	14QK-2108P1	010	83203	89436	
	14QK-2113P3	010	85001	89410	
	14QK-288-P1	010	85007	89412	
	14QK-29001P2	010	85303	89422	
	14QK-29301P1	010	83207	89407	
	14QK-29301P2	010	83207	89407	
	14QK-3108	01-	85080	
	14QK-366P2	010	85036	89405	
	14QK-366P3	010	85036	89405	
	14QK-372M3	010	83122	89406	
	14QK-378	010	83215	
	14QK-423M		010	85978	
	14QK-428	01-	85080	
	14QK-428M	01-	85080	
	25621571	010	83215	
	25626149	01-	85080	
	47170000451	01-	85080	
	471700002861	010	85014	
	57241-004		01-	83110	
	5966-90044025	010	83209	89414	
	651103	010	85036	89405	
	Additional O.E.M. Interchanges	14QK-140P1	010	83225			
		14QK-20001P2	010	85308 or 89422			
		14QK-2100	010	83221			
		14QK-2100P1	010	83221			
14QK-2110P1		010	85305				
14QK-282P1		010	83216				
14QK-282P3		010	83216				
14QK-288P2		010	83217				
14QK-29302P1		010	83207 or 89407				
14QK-372M		010	83221				
14QK-392M		010	85005 or 89430				
25624365		010	83217				
4940654		010	83216				
5533699		010	85302 or 89420				
5554184		010	85302 or 89420				
650102		010	85001 or 89410				
650107		-10	85316 or 89426				
650107MT		-10	85316 or 89426				
650400MT		-10	85033 or 89427				
650402		-10	85311 or 89424				
650402MT	-10	85311 or 89424					
650404	-1-	85310 or 89423					

APPLICATION GUIDE - TRUCKS, TRAILERS, AND BUSES

Year Año Année	Model Modelo Modèle	OEM #	Front		Rear	
						
			Fleetline	GasSLX	Fleetline	GasSLX

MACK(Cont'd.)

Additional O.E.M. Interchanges(Cont'd.)

Additional O.E.M. Interchanges	OEM #		
	650404MT	- -	85310 or 89423
	650405	0 0	85023 or 89415
	650405MT	0 0	85023 or 89415
	650406	0 0	85024 or 89416
	650408	- 0	85319 or 89428
	650408MT	- 0	85319 or 89428
	651012	0 0	83221
	651151	0 0	83209 or 89414
	70042	0 0	85302 or 89420

MACK CAB SHOCKS

CH Series

Models with O.E.M. Number	OEM #		
	14QK-411	0 0	83007
	14QK-411AM	0 0	83007
	14QK-411M	0 0	83007
	25631922	0 0	83007

CHN - Series

05 - 07	CHN-613 Models with O.E.M. Number	14QK-3103M	0 -	83050
		20874147	0 -	83050

CHU - Pinnacle Series

- 17	CHU-613 Models with Hi - Roof Sleeper Cabs with O.E.M. Number	25625636	0 -	83045
	CHU-613 Models with O.E.M. Number	21345869	0 0	83066
		21490486	0 0	83066
08 - 11	CHU-613 Models with O.E.M. Number	14QK-303M	0 -	83050
		14QK-3103M	0 -	83050
		20874147	0 -	83050

CL Series

	Models with O.E.M. Number	14QK-391AM	0 -	83041
		14QK-391AM2	0 -	83041

CT, CTX - Series

	Models with O.E.M. Number	14QK-303M	0 -	83050
		14QK-3103M	0 -	83050
		20874147	0 -	83050

CX (Vision) Series

	Models with Sleeper Cabs w/O.E.M. Numbers	14QK-399M	0 -	83045
		14QK-399M2	0 -	83045
		14QK-399M3	0 -	83045
		25625635	0 -	83045
		25625636	0 -	83045
		25625637	0 -	83045





CXN Series

05 - 06	CXN-613 Models with O.E.M. Number	14QK-3103M	0 -	83050
		20874147	0 -	83050
- 14	Models with Sleeper Cabs w/O.E.M. Numbers	25625635	0 -	83045

CXP - Series

06 - 07	CXP-613 Day Cab Models	14QK-3103M	0 -	83050
		20874147	0 -	83050
11 - 12	CXP-613 Models with Sleeper Cabs	25625636	0 -	83045

APPLICATION GUIDE - TRUCKS, TRAILERS, AND BUSES

Year Año Année	Model Modelo Modèle	OEM #	Front		Rear	
			 Fleetline	 GasSLX	 Fleetline	 GasSLX

MACK CAB SHOCKS(Cont'd.)

CXU - Pinnacle Series(Cont'd.)

2008 - 17	CXU-613 Models with Hi - Roof Sleeper Cabs with O.E.M. Number	25625636	01-	83045
2011 - 16	CXU-613 Models with Mid - Roof Sleeper Cabs with O.E.M. Number	25625635	01-	83045
	CXU-613 Models with O.E.M. Number	21345869	010	83066
		21490486	010	83066
08 - 11	CXU-613 Models with O.E.M. Number	14QK-303M	01-	83050
		14QK-3103M	01-	83050
		20874147	01-	83050

Granite Series - GU-432, GU-533, GU-713, GU-813

	GU 713 and GU 813 Models with O.E.M. Number	21345869	010	83066
		21490486	010	83066
08 -	GU 713 and GU 813 Models with O.E.M. Number	14QK-432M	01-	83050
		20873442	01-	83050

R - Series

	R 600 Tractors with Link Cabmate Model MCR600	1201-0012	010	83023
		1202-0012	010	83023
	R, RD Models	14QK-382	01-	83018
		14QK-382-P2	01-	83018
	R, RD400 & 600 Models with Cab Air suspension	14QK-2111-P4	01-	83019
	RS & Superliner Tractors with Link Cabmate Model MCRS600	1201-0012	010	83023
		1202-0012	010	83023
	RW Models	14QK-29303-P2	-1-	83014

TD - Titan Series

- 17	TD - Titan Models with O.E.M. Number	14QK-440M	01-	83058
		21154397	01-	83058





Additional Applications

02 - 07	CV-713 Models with O.E.M number	14QK-391BM	01-	83041
	MH Models with Air Cab	14QK-374	-10	83003
		14QK-376	-10	83003
	Models with Link Cab Suspension	1202-0012	010	83023
		1202-0022	010	83046
		1202-0032	010	83016
	Models with O.E.M number	14QK-397AM	010	TBR-83905
	Models with O.E.M. Number	14QK-2111	01-	83019
		14QK-2111-P2	01-	83019
		14QK-391BM2	01-	83041
		14QK-391M	01-	83041
		14QK-391M2	01-	83041
		14QK-439M	01-	83050
		21154393	01-	83050
		21345868	010	83066
		25622612	01-	83041
		25622613	01-	83041
		25624837	01-	83041

MAECO

	Bus with O.E.M. Number	1668722		85030	...	010	85030	89440
	FedEx Trucks with O.E.M. Number	16950	010	83118
	UPS Trucks with O.E.M. Number	16949		01-	83120	...
	Additional O.E.M. Interchanges	1085	010				83214	





APPLICATION GUIDE - TRUCKS, TRAILERS, AND BUSES

Year Año Année	Model Modelo Modèle	OEM #	Front		Rear	
						
			Fleetline	GasSLX	Fleetline	GasSLX

MAECO(Cont'd.)

Additional O.E.M. Interchanges	12608	010	83125
	12788	010	83216
	12866	010	83207 or 89407
	16385	010	83215
	16720	010	83107
	16767	010	85013
	16768	010	83217
	16769	010	83221
	16770	010	83209
	16771	010	83126 or 89430
	16772	010	83122 or 89406
	16773	010	85005
	16774	010	83215
	16775	010	83207 or 89407
	16776	010	83122
	16777	010	85006
	16778	010	83203
	16779	010	83126 or 89440
	16780	010	83123 or 89405
	16781	010	85006
	16787	010	85030 or 89440
	6025	010	83122 or 89406
	6026	010	83204
	70018	010	85303 or 89422
	70021	010	85303 or 89422
	70029	010	85308 or 89422
	70034	010	85302 or 89420
	70039	010	85303 or 89422
	70041	010	85305
	70042	010	85302 or 89420
	70088	010	85307
	70123	010	85716
	70127	010	85006 or 89401
	70128	010	85006 or 89401
	70162	010	85716
	70163	010	85302 or 89420
	70164	010	85716
	70300	010	85320 or 89429
	70312	010	85001 or 89410
	70315	010	85063
	70317	010	89432
	70331	010	85314 or 89425
	70332	010	83314
	70334	-10	85316 or 89426
	70397	010	85006
	70402	010	85305
	70642	010	85300
	70644	010	85334
70646	010	85313	
70647	-1-	85701	
70648	010	89414	
70650	010	89440	

APPLICATION GUIDE - TRUCKS, TRAILERS, AND BUSES

Year Año Année	Model Modelo Modèle	OEM #	Front		Rear	
						
			Fleetline	GasSLX	Fleetline	GasSLX

MAECO(Cont'd.)

Additional O.E.M. Interchanges	70651	010	85013 or 89414		
	70652	010	85030 or 89440		
	70663	010	85013 or 89414		
	70691	010	85007		
	70720	010	85934		
	70721	010	83125		
	74039	010	85303 or 89422		
	OE10881	10	85711		
	OE10882	01-	85740		
	OE10883	010	85339		
	OE12425	010	83214		
	SC-2920	010	83176		

MANDALAY COACH

Class A MotorHomes

04 - 06	Mandalay Series MotorHomes with Freightliner XC Chassis ADL200 Suspension w/ 20K Rear AS120 Front Suspension Rear Shock with O.E.M. Number ZF - IFS Front Suspension with 23,000 lb GVW or Greater	16-16873-000							
		141700131810	010	83160	...	85029	...		
		16-16737-000	010	83160		
		16-16874-000	010	83160		
		141700131809		010	85029	...	
		16-16736-000		010	85029	...	
		16-18103-000	1-	85900		
		481700000493	1-	85900		
		06	Presidio & Valencia Series MotorHomes with Freightliner XC Chassis AS120 Front Suspension Rear Shock with O.E.M. Number ZF - IFS Front Suspension with 23,000 lb GVW or Greater	141700131810	010	83160
				16-16737-000	010	83160
16-16874-000	010			83160		
141700131809				010	85029	...	
16-16736-000				010	85029	...	
16-18103-000	1-			85900		
481700000493	1-			85900		

MARMON

Models with O.E.M. Number	1-7001	010	83216	
	37-1-1	010	83122	89406	
	51-139-28		010	85003	89411
	51-163-7		010	83123	89405
	576451	010	83122	89406	
	665147	010	83216	

MARMON CAB SHOCKS

81 -	Conventional Tractors with Link Cabmate Model MARC57-B	1202-0054	010	83021		
	Models with Link Cab Suspension	1202-0022	010	83046		





MATSON SCHOOL BUS

	Models with O.E.M. Number	5392387	010	85303	89422
--	---------------------------	---------	-----	-------	-------	-----	-----

MC NEILUS TRUCK & MAN.

Mc Neilus part number	1139039 MTM	010	85334
	1139046 MTM		01-	83112

APPLICATION GUIDE - TRUCKS, TRAILERS, AND BUSES

Year Año Année	Model Modelo Modèle	OEM #	Front		Rear	
						
			Fleetline	GasSLX	Fleetline	GasSLX

MC NEILUS TRUCK & MAN.(Cont'd.)

Mc Neilus part number	1139059 MTM	010	83207	89407
	1139069 MTM	010	83209	89414
	12405FX1 MTM	85303	...	010	85303	89422
	1323106 MTM	010	85305	...
	1333575 MTM	010	85072	...
	1340975 MTM	01-	83142	...
	1340976 MTM	85919
	1340979 MTM	01-	83143	...
	1360386 MTM	010	85323	89436
	1367383 MTM	010	83147	...
	1396513 MTM	85959
	1398980 MTM	010	83127	...
	1404068 MTM	010	85980	...
	1404068 MTM	010	85087	...
	1410046 MTM	85919
	1411765 MTM	010	83148	...
	1412744 MTM	010	85966	...
	1429317 MTM	85919				
	1431085 MTM	010	85738	...
	1432386 MTM	010	85965	...
	1433009 MTM	010	85962	...
	1468783 MTM	010	85345	...
	1485576 MTM	010	85979	...
	1491909 MTM	010	83128	89436
	1KK552 MTM	010	85967	...
	2218640 MTM	83009				
	3215395 MTM	01-	83112	...
	3HR582 MTM	010	85013	89414
	3HR582 MTM	010	85013	89414
	3HR916 MTM	010	83207	89407
	4HA569 MTM	85932	89453	
	4KP398 MTM	85933	89454	
	5HA994 MTM	010	85916	...
	5HB645 MTM	01-	83109	...
	5KK247 MTM	01-	85977	...
	64442AX MTM	010	83128	...
	6HA961 MTM	010	83123	89405
	6HB390 MTM	010	83137	...
	6HD720 MTM	010	85909	...
	6HS773 MTM	010	83122	89406
	6KP857 MTM	010	85000	89436
	7HS237 MTM	010	83122	89406
	7HS534 MTM	010	85906	89407
	8KK524 MTM	010	83168	...
	9HB362 MTM	010	85976	...
	9KK464 MTM	010	85079	...
	Models with O.E.M. Number	217330		010	85303	

MERITOR

Air Link Suspensions with O.E.M. Number	14QK-3100	010	85739	...
	446-51-211	010	85739	...
AL460 Air Link Suspension	700115	010	85712	...

APPLICATION GUIDE - TRUCKS, TRAILERS, AND BUSES

Year Año Année	Model Modelo Modèle	OEM #	Front			Rear		
			Fleetline	GasSLX		Fleetline	GasSLX	

MERITOR(Cont'd.)

	AL520 Air Link Suspension	700115	010	85712	...
	FlexAir 9NB Suspension with O.E.M. Number	21224745	010	86203	...
		21224778	010	86202	...
		671502	010	86202	...
		671503	010	86203	...
	FS230 Trailer Suspension (Light Duty)	A-7805P-1030	010	85737	...
	FS230 Trailer Suspension (Std Duty)	671507	010	87015	...
		A-7805L-1026	010	87015	...
	FS230T	21227751	010	87015	...
		671020	010	87015	...
	Meritor Kit 11210 includes washers and nuts (For Shock only)	KIT11210	010	87015	...
	MTA 25T / MTA 30T Trailer Air Suspension	671506	010	86200	...
		7805-F-1020	010	86200	...
		A-7805F-1020	010	86200	...
	RC S 9L Suspension	21228392	010	86201	...
		671500	010	86201	...
	RFS 23T / 25T / 30T Trailer Air Suspensions	21227751	010	87015	...
		A-7805L-1026	010	87015	...
	RHP11, RHP55 and RideSentry Trailer Suspension	202447	010	85919	...
		A-3280-M-9711	010	85919	...
01 -	RHP11, RHP55 and RideSentry Trailer Suspension	A-7805L-1000	010	85919	...
	Models with O.E.M. Number	671907	010	85919	...
		680705	010	85737	...

MITSUBISHI-FUSO

FE Series

07/86 -	FE434, FE439, FE444, FE450	MB025382				
		MB161497	010	G63299	...
96 - 97	FE639, FE639SP, FE639HDT	MC114595	010	G63405	...

FF Series

86 - 87	FF415	MC813511	- -	G63398
----------------	-------	----------	-----	---------------	-----	-----	-----

FH Series

10/87 - 96	FH100 Suspension (All)	MC809390	- -	83103	...
		MC826268	- 0	G63610

FK Series

11/85 - 11/86	FK414	MC813511	- -	G63398
06/88 - 02/91	FK455	MC814614	- 0	85009
03/91 - 06/93	FK457	MC814614	- 0	85009





FM Series

06/88 - 02/91	FM555	MC814614	- 0	85009
11/85 - 05/88	FM555	MC813135	- -	83456	89447
05/89 - 06/93	FM557	MC814614	- 0	85009

MOHAWK

	Additional O.E.M. Interchanges	01-0100-905	010	85303 or 89422			
		020273544	010	83203 or 89436			
		050134508	010	85718			
		10134504	010	85715			

APPLICATION GUIDE - TRUCKS, TRAILERS, AND BUSES

Year Año Année	Model Modelo Modèle	OEM #	Front		Rear	
						
			Fleetline	GasSLX	Fleetline	GasSLX

MOHAWK(Cont'd.)

Additional O.E.M. Interchanges	10134506	010	85714			
	10234503	010	85714			
	10234504	010	85717			
	1235233	010	85736			
	22012079	- -	85701			
	22012082	010	85702			
	22012114	010	85700			
	4968853	010	83216			
	6-367-7	010	85305			
	680323	010	85700			
	680332	- -	85701			
	680485	01-	85733			
	695195	- -	85707			
	695196	- -	85707			
	97-2201-00007	- 0	85703			
	97-2201-00011	010	85704			
	97-9999-02320	010	85704			
MM-6886	010	83207 or 89407				
MM-6957	010	83225				
MM-74029	010	85308 or 89422				

MONACO

98 - 14	All Models with W20 & W22 Workhorse Motorhome Chassis	24-186629	010	85125
		F4-BE5-B492-HO	010	85125
99 - 03	Monarch and LaPalma Models with F53 Motorhome Chassis (16,000 lb to 22,000 lb GVW)	010	83209	...	010	83122	...
90 - 97	Monarch and LaPalma Models with F53 Motorhome Chassis (7.5 L, Gas V8)	010	83209	...	010	85097	...
01 - 04	Monarch and LaPalma Models with W20 & W22 Workhorse Motorhome Chassis	24-186537		01-	85126	...
		24-186629	010	85125
		F4-BE5-A011-HO		01-	85126	...
		F4-BE5-B492-HO	010	85125
95 - 99	MotorHomes with Freightliner XC Chassis (22,000 to 26,000 lb GVW)	010	83160	...	010	85029	...
01 - 04	Vacationer Models with W20 & W22 Workhorse Motorhome Chassis	24-186537		01-	85126	...
		24-186629	010	85125
		F4-BE5-A011-HO		01-	85126	...
		F4-BE5-B492-HO	010	85125

MOR-RYDE SUSPENSION





Bus Suspension	- -	83103	...
	U0109-006		010	G63866	...
Recreational Vehicle	U0109-014		- -	83400	...
	U0109-018		010	G63866	...
Trailer Rear	U0109-007		010	G63183	...

MOTOR COACH INDUSTRIES

Additional Applications

Drive Axle	12J-5-2		01-	85312	...
	12J-5-4		01-	85312	...
	12L-5-71		- -	85708	...
	T14-1081		01-	85729	...

APPLICATION GUIDE - TRUCKS, TRAILERS, AND BUSES

Year Año Année	Model Modelo Modèle	OEM #	Front		Rear	
						
			Fleetline	GasSLX	Fleetline	GasSLX

MOTOR COACH INDUSTRIES(Cont'd.)









Additional Applications(Cont'd.)

Year	Model	OEM #	Front	Rear
	Low Floor Bus Models with O.E.M. Number	12L-5-99	...	010 85339
	MC5, MC7, MC8	12B-5-1	85735	010 85735
		3178157	85700	010 85700
		680323	85700	010 85700
	RTS Bus with "V" Drive Rear	G1101590GS	...	010 85713
	RTS Bus with Normal Front	695117	-1- 85701	...
		74410	-1- 85701	...
	RTS Bus with Regular Rear	G1011822	...	010 85702
	RTS Bus with Solid Front Axle	22024673	-10 85710	...
	Steering - Tag Axle	12L-4-170	...	010 83158
		654789	...	010 83158
	Tag Axle	12-05-6068	...	-1- 85727
		12J-5-11	...	010 85313
		12J-5-3	...	010 85313
		T14-1082	...	-1- 85727

D - Series Coaches

D 4000 Coach (Drive Axle)	12-05-1177	01-	85729	...	
	12-05-1328	01-	85729	...	
	(Front Axle)	12-05-1176	-1-	85728
		12-05-1327	-1-	85728
	(Trailing Axle)	12L-5-97	-1-	85728
		12-05-1178	010	85339	...
		12-05-1194	010	85339	...
	12L-5-99	010	85339	...	
D 4005 Coach (Drive Axle)	12-05-1177	01-	85729	...	
	12-05-1328	01-	85729	...	
	(Front Axle)	12-05-1176	-1-	85728
		12-05-1327	-1-	85728
	(Trailing Axle)	12L-5-97	-1-	85728
		12-05-1194	010	85339	...
		12L-5-99	010	85339	...
D 4500 Coach (Drive Axle)	12-05-1177	01-	85729	...	
	12-05-1328	01-	85729	...	
	(Front Axle)	12L-5-88	01-	85729	...
		85729	01-	85729	...
	(Trailing Axle)	12-05-1176	-1-	85728
		12-05-1327	-1-	85728
		12L-5-67	-1-	85728
		12-05-1179	-1-	85727	...
	12-05-1329	-1-	85727	...	
	12L-5-114	-1-	85727	...	
D 4505 Coach (Drive Axle)	12-05-1177	01-	85729	...	
	12-05-1328	01-	85729	...	
	(Front Axle)	12L-5-88	01-	85729	...
		12-05-1176	-1-	85728
		12-05-1327	-1-	85728
		12L-5-67	-1-	85728

APPLICATION GUIDE - TRUCKS, TRAILERS, AND BUSES

Year Año Année	Model Modelo Modèle	OEM #	Front		Rear	
						
						
			Fleetline	GasSLX	Fleetline	GasSLX

MOTOR COACH INDUSTRIES(Cont'd.)

D - Series Coaches(Cont'd.)

	(Trailing Axle)	12-05-1179		- -	85727	...
		12-05-1329		- -	85727	...
		12L-5-114		- -	85727	...
	DL3 Bus	12-05-1327	- -	85728
		12-05-1328		0 -	85729	...
		12L-5-88		0 -	85729	...
		12L-5-89		0 -	85729	...
		12L-5-96	- -	85728
		12L-5-97	- -	85728
	DL3 Bus -Drive Axle	12J-5-10		0 -	85733	...
	DL3 Bus -Tag Axle	01-205219		- -	85727	...
		12-05-1329		- -	85727	...
		12L-5-100		- -	85727	...
		12L-5-114		- -	85727	...
		T12-1208		- -	85727	...

E - Series Coaches

	E 4500 Coach (Drive Axle)	12-05-1022		0 -	85970	...
		12-05-1102		0 -	85970	...
		12-05-1138		0 -	85970	...
		12-05-1148		0 -	85970	...
		12-05-1188		0 -	85970	...
	(Front Axle)	12-05-1150	- 0	85711
		12-05-1165	- 0	85711
	(Trailing Axle)	12-05-1139		0 -	85341	...
		12-05-1147		0 -	85341	...
		12-05-1166		0 -	85341	...





G - Series Coaches

	G 4500 Coach Drive Axle	12-05-6001		0 -	85740	...
		12-05-6054		0 -	85740	...
	Front Axle	12-05-6000	- 0	85711
		12-05-6053	- 0	85711
	Tag Axle Trailing Axle	1497835	- 0	85711
		1498565		0 0	85339	...
		12-05-6002		0 0	85339	...
		12-05-6033		0 0	85339	...
		12-05-6055		0 0	85339	...
					0 0	85339

J - Series Coaches

	J 4500 Coach (Drive Axle)	12-05-1022		0 -	85970	...	
		12-05-1138		0 -	85970	...	
		12-05-1148		0 -	85970	...	
		12-05-1188		0 -	85970	...	
	(Front Axle with OEM Number)	12-05-1137	0 -	85340	
		12-05-1142	0 -	85340	
		12-05-1146	0 -	85340	
		12-05-1150	- 0	85711	
		12-05-1165	- 0	85711	
	(Trailing Axle)	12-05-1228	- 0	85711	
		12-05-1139		0 -	85341	...	
					0 -	85341	...
					0 -	85341	...

APPLICATION GUIDE - TRUCKS, TRAILERS, AND BUSES

Year Año Année	Model Modelo Modèle	OEM #	Front		Rear	
						
			Fleetline	GasSLX	Fleetline	GasSLX

MOTOR COACH INDUSTRIES(Cont'd.)





J - Series Coaches(Cont'd.)

(Drive Axle)	12-05-1147	01-	85341	...
	12-05-1166	01-	85341	...

Additional O.E.M. Interchanges

Models with O.E.M. Number	12-05-1021	01-	85340
	12-05-1023	01-	85341	...
	12-05-1101	01-	85340
	12-05-1103	01-	85341	...
	12-05-1170	01-	85340
	12-05-1199	01-	85729	...
	12-05-1242	-1-	85728
	12-05-1243	01-	85729	...
	12-05-1244	-1-	85727	...
	12-5-1-G	010	85700
	12-5-1-GS	010	85700
	12B-5-1-G	010	85700
	12B-5-1-GS	010	85700
	12J-5-10GS	01-	85733	...
	12L-5-58	-1-	85728
	12L-5-69	010	85700
	12L-5-98	010	85339	...
	12T-1-13	010	85303	...	85303	89422
	12TA-01-013	010	85303	...	85303	89422
	1498200	01-	85740	...
	22012067	010	85700
	22024061	010	85704	...
	22045526	010	85702	...
	22046485	-10	85710
	3178154	010	85735	...
	4975515	-1-	85701
	4975515GS	-1-	85701
	5316984	010	85313	...	85313	...
	63-0127GS	010	85303	...	85303	89422
	680231	010	85313	...
	680232	01-	85733	...
	680322	010	85704	...
	680323	010	85700
	680350	-10	85710
	680369	-1-	85708	...
	680374	-1-	85728
	680441	01-	85729	...
	680452	010	85339	...
	680462	-1-	85728
	680470	010	85713	...
	680482	-1-	85727	...
	680485	01-	85733	...
	680544	-10	85711
	680546	010	85339	...
	680602	010	85339	...
	680677	-1-	85728
	680680	01-	85729	...
680681	-1-	85727	...	

APPLICATION GUIDE - TRUCKS, TRAILERS, AND BUSES

Year Año Année	Model Modelo Modèle	OEM #	Front		Rear	
						
			Fleetline	GasSLX	Fleetline	GasSLX

MOTOR COACH INDUSTRIES(Cont'd.)

Additional O.E.M. Interchanges(Cont'd.)





Models with O.E.M. Number	695125	010	85704	...
	97-9999-02585	01-	85723
	G1101590	010	85713	...
	G1201338	-10	85710
	G1201339	010	85702	...
	G5008069	010	85700
	OE10086S	010	85702	...
	OE10881	-10	85711
	OE10882	01-	85740	...
	OE10883	010	85339	...
	T14-1029	-1-	85701
	T14-1045GS	010	85700
	T14-1048	010	85302	89420
	T14-1080	-1-	85728
	Additional O.E.M. Interchanges	12G-5-1	010	85700		
12J-5-6		010	85313			
12J-5-7		01-	85312			
12J-5-71		01-	85733			
12J-5-9		010	85700			
12L-5-70		010	85700			
12L-5-72		010	85709			
22012066		-1-	85707			
22012079		-1-	85701			
22052014		010	85702			
6314933		-1-	85708			
680332		-1-	85701			
680333		-1-	85708			
690029		010	85700			
97-2201-00151		010	85700			
97-2210-00164		-1-	85708			
97-9999-02514		010	85700			
97-9999-02634	01-	85733				

MUNCIE RECLAMATION

Additional O.E.M. Interchanges

Models with O.E.M. Number	665459	-1-	89447	...
	665568	010	85051	...
	H53-20415-006	010	85051	...
	MR6394	01-	85723
Additional O.E.M. Interchanges	665569	010	85045			
	680334	-1-	85709			
	97-2210-00164	-1-	85708			
	H53-21144-004	010	85045			
	MR1623	010	85700			
	MR1710	010	85713			
	MR1751	010	85713			
	MR1763	010	85300 or 89419			
	MR1765	010	85713			
	MR25767	010	85702			
	MR2960	010	85702			
MR2961	-1-	85701				

APPLICATION GUIDE - TRUCKS, TRAILERS, AND BUSES

Year Año Année	Model Modelo Modèle	OEM #	Front		Rear	
						
			Wrench	Wrench	Wrench	Wrench
			Fleetline	GasSLX	Fleetline	GasSLX

MUNCIE RECLAMATION(Cont'd.)

Additional O.E.M. Interchanges(Cont'd.)

Additional O.E.M. Interchanges	MR2996	010				85704
	MR2997	-10				85703
	MR3303	-1-				85709
	MR3304	-10				85710
	MR3304H	-1-				85709
	MR3306	-1-				85705 or 89447
	MR3307	-1-				85707
	MR3650	-1-				85707
	MR6535	-1-				85708
	MR6536	-1-				85722
	MR7388	-10				85710

NATIONAL COACH CORP

Eldorado Coach RE-29	C800853	010	83207	89407		...
----------------------	---------	-----	--------------	--------------	--	-----

NAVISTAR - SEE INTERNATIONAL (NAVISTAR)

--	--	--	--	--	--	--









NEOPLAN BUS

Mini-Bus	24-1700-106-149					83216
	24-1700-999-362	-10				85009
	BN1002002	-10				85009
	BT1002011			010		83216
Model 40	25-1700-101-426					85705
	DT1002002					85707
Model 80B	CL1002003					85705
	DZ1002002					85705
Models with O.E.M. Number	680307					85705
	680308					85706
	AA1002002					85705
	AA1002003					85705
	AA1802002					85705
	AC1002002					85705
	AC1002002GS					85705
	AC1002003					85705
	DT1802002					85705
	GJ1002002					85706
	GJ1002003					85705
Additional O.E.M. Interchanges	97-9999-02519	-1-				85707
	CI 1002003	-1-				85705 or 89447

NEW FLYER

	Diesel Low Floor Coach	015813				85708
01 - 11	Transit Buses (Low Profile) with O.E.M. Number	203398	-1-			85346
		204428				85347
02 -	Transit Buses (Low Profile) with O.E.M. Number	152959				85708
		680671				85708
91 -	Transit Buses (Low Profile) with O.E.M. Number	009863	-1-			85722
		016415	-1-			85722

APPLICATION GUIDE - TRUCKS, TRAILERS, AND BUSES

Year Año Année	Model Modelo Modèle	OEM #	Front		Rear	
						
						
			Fleetline	GasSLX	Fleetline	GasSLX

NEW FLYER(Cont'd.)

91 -	Transit Buses (Low Profile) with O.E.M. Number	680346	- -	85722
	Models with O.E.M. Number	69536140Y	- 0	87016
		G1011823	- 0	85710
	Additional O.E.M. Interchanges	015915	- 0				85711	
		064845	- 0				85711	
		68027440Y	0 0				85716	
		68035041Y	- 0				85710	
		680352	- 0				85711	
		68037840B	0 0				85720	
		68050440X	0 0				85716	
		68050640Y	0 0				85718	
		690102	- 0				85711	
		69536640Y	0 0				85732	
		97-2210-00164	- -				85708	

NEWAY (HOLLAND) SUSPENSION SYSTEMS - SEE SAF HOLLAND

Refer to SAF Holland Section for application information

NEWMAR CORP

Class A MotorHomes









02 - 04	Dutch Star & Moundain Aire Series MotorHomes with Freightliner XC Chassis AS120 Front Suspension	141700131810	0 0	83160
			0 0	83160
			0 0	83160
				0 0	85029	...
				0 0	85029	...
			- -	85900
			- -	85900
02 - 05	Kountry Star Series MotorHomes with Freightliner XC Chassis AS120 Front Suspension	141700131810	0 0	83160
			0 0	83160
			0 0	83160
				0 0	85029	...
				0 0	85029	...
			- -	85900
			- -	85900
06	Ventana Series MotorHomes with Freightliner XC Chassis AS120 Front Suspension	141700131810	0 0	83160
			0 0	83160
			0 0	83160
				0 0	85029	...
				0 0	85029	...
			- -	85900
			- -	85900

NISSAN

UD 1300 Series

	UD 1300 Models Steer Axle	56110-T8123	- 0	G63432
			- 0	G63432
			- 0	G63432

APPLICATION GUIDE - TRUCKS, TRAILERS, AND BUSES

Year Año Année	Model Modelo Modèle	OEM #	Front				Rear			
										
										
Fleetline		GasSLX		Fleetline		GasSLX				

NISSAN(Cont'd.)

UD 1800 Series(Cont'd.)

11 - 13	Models with O.E.M. Number	56101-30Z01	- O	83161
		56101-30Z02	O -	G63610
		56110-30Z01	- O	83161
		56110-30Z02	O -	G63610
89 - 94	Models with O.E.M. Number	56101-Z5008	- O	83114
		56110-Z5008	- O	83114
95 - 98	Models with O.E.M. Number	56101-30Z01	- O	83161
		56101-30Z02	O -	G63610
		56110-30Z01	- O	83161
		56110-30Z02	O -	G63610

UD 18CS Series

05 - 10	Models with O.E.M. Number	56101-30Z01	- O	83161
		56110-30Z01	- O	83161
99 - 04	Models with O.E.M. Number	56101-Z5008	- O	83114
		56110-Z5008	- O	83114
		56201-Z5001		- -	85085	...
		56210-Z5001		- -	85085	...

UD 18HD Series

99 - 10	Models with O.E.M. Number	56101-30Z01	- O	83161
		56101-30Z02	O -	G63610
		56110-30Z01	- O	83161
		56110-30Z02	O -	G63610

UD 2000 Series

	Models with O.E.M. Number	56110-Z5011	- O	G63610
89 - 94	U D 2000 Models with O.E.M. Number	56101-Z5008	- O	83114
		56110-Z5008	- O	83114
95 - 13	U D 2000 Models with O.E.M. Number	56101-30Z01	- O	83161
		56101-30Z02	O -	G63610
		56110-30Z01	- O	83161
		56110-30Z02	O -	G63610
89 - 13	U D 2600 Models with O.E.M. Number	56101-Z5017	- O	83162
		56110-Z5017	- O	83162
92 - 94	U D 2600 Models with O.E.M. Number	56201-Z5001		- -	85085	...
		56210-Z5001		- -	85085	...
89 - 94	U D 2800 Models with O.E.M. Number	56101-Z5017	- O	83162
		56110-Z5017	- O	83162
92 - 94	U D 2800 Models with O.E.M. Number	56201-Z5001		- -	85085	...
		56210-Z5001		- -	85085	...

UD 23DH Series

95 - 13	Models with O.E.M. Number	56101-30Z01	- O	83161
		56101-30Z02	O -	G63610
		56110-30Z01	- O	83161
		56110-30Z02	O -	G63610











UD 23LP Series

95 - 13	Models with O.E.M. Number	56101-30Z01	- O	83161
		56101-30Z02	O -	G63610
		56110-30Z01	- O	83161
		56110-30Z02	O -	G63610

UD 3000 Series

89 - 91	U D 3000 Models with O.E.M. Number	56101-Z5017	- O	83162
---------	------------------------------------	-------------	-----	--------------	-----	--	-----	-----

APPLICATION GUIDE - TRUCKS, TRAILERS, AND BUSES

Year Año Année	Model Modelo Modèle	OEM #	Front				Rear			
										
										
Fleetline		GasSLX		Fleetline		GasSLX				

NISSAN(Cont'd.)

UD 3000 Series(Cont'd.)

89 - 91	U D 3000 Models with O.E.M. Number	56110-Z5017	- O	83162
95 - 00	U D 3000 Models with O.E.M. Number	56101-Z5017	- O	83162
		56110-Z5017	- O	83162
89 - 94	U D 3300 Models with O.E.M. Number	56101-Z5017	- O	83162
		56110-Z5017	- O	83162
92 - 94	U D 3300 Models with O.E.M. Number	56201-Z5001		- -	85085	...
		56210-Z5001		- -	85085	...
99 - 13	U D 3300 Models with O.E.M. Number	56101-Z5017	- O	83162
		56110-Z5017	- O	83162
		56201-Z5001		- -	85085	...
		56210-Z5001		- -	85085	...









Additional Applications

92 - 94	30HD Models with O.E.M. Number	56101-Z5017	- O	83162
		56110-Z5017	- O	83162
		56201-Z5001		- -	85085	...
		56210-Z5001		- -	85085	...
92 - 94	30SD Models with O.E.M. Number	56101-Z5017	- O	83162
		56110-Z5017	- O	83162
		56201-Z5001		- -	85085	...
		56210-Z5001		- -	85085	...
89 - 91	500T Models with O.E.M. Number	56101-Z5017	- O	83162
		56110-Z5017	- O	83162
92 - 94	600T Models with O.E.M. Number	56101-Z5017	- O	83162
		56110-Z5017	- O	83162
		56201-Z5001		- -	85085	...
		56210-Z5001		- -	85085	...

NOVA BUS

	Classic Bus with O.E.M. Number	97-2201-00151		85700	...	O O	85700	...
	Low Floor Bus Models with O.E.M. Number	481700131250	O O	85377
		481700131252		O O	85378	...
		680480	O O	85377
		N16248	O O	85377
		N16249		O O	85378	...
		N21543		O O	85378	...
		N31830		O O	85378	...
		N31831	O O	85377
	RTS Bus	22012079	- -	85701
		22045526		O O	85702	...
		22052014		O O	85702	...
		4975515	- -	85701
		695117	- -	85701
		74410	- -	85701
		G1011822		O O	85702	...
		G1203223		O O	85702	...
		G1205763	O O	87019
		G1205763-001	O O	87019
		OE 10086S		O O	85702	...
	RTS Bus with "V" Drive	G1011823	- O	85710
		G1101590		O O	85713	...
	RTS Bus with Solid Front Axle	22024673	- O	85710

APPLICATION GUIDE - TRUCKS, TRAILERS, AND BUSES

Year Año Année	Model Modelo Modèle	OEM #	Front		Rear	
						
						
			Fleetline	GasSLX	Fleetline	GasSLX

NOVA BUS(Cont'd.)

Models with O.E.M. Number	12J-5-10		01-	85733	...
	12J-5-11		010	85313	...
	680231		010	85313	...
	680232		01-	85733	...
	680323	010	85700
	680326	010	85700
	680470		010	85713	...
	680481		010	85378	...
	G1201338	-10	85710
	G1201339		010	85702	...
	G5008070	010	85700
	N22212	010	85700
	Additional O.E.M. Interchanges	97-9999-02514	010	85700			

OLE GRANNING

Models with O.E.M. Number	1086	010	83217
---------------------------	------	-----	--------------	-----	--	-----	-----

ONEIDA PRODUCTS

School Bus w/Heavy Duty Suspension		85307	...	010	85307	...
School Bus w/Standard Suspension		83216	...	010	83216	...





OPTIMA BUS CORP

Buses with Ridewell RAS - 227 Models Steer Axle Air Suspension w/ O.E.M. Number	1260008		010	87017	...
	90-2610-SP1		010	87017	...

ORION BUS INDUSTRIES

Orion 1	010134505-4	010	85715
	010134509	010	85717
	010234503-4		010	85308	89422
	010234506		010	85714	...
Orion 102	050134501-4	010	85716
	050230501		010	85716	...
	050231505		010	85716	...
	680504		010	85716	...
Orion II	010134505-4	010	85715
	010234503-4		010	85308	89422
	020117504	010	85720
	020273541	010	83203	89436	
	020273541-4		010	85000	89436
	020273544	010	83203	89436	
	020273546		010	85719	...
	020273547		010	85719	...
	020273548		010	85719	...
	020273549		010	85719	...
	20117501	010	85720
	20117503	010	85720
	20117504	010	85720
20117505	010	85720	
Orion V	010134508-4	010	85718
	050134502-4	010	85718
	050134506-4	010	85718

APPLICATION GUIDE - TRUCKS, TRAILERS, AND BUSES

Year Año Année	Model Modelo Modèle	OEM #	Front		Rear	
						
			Fleetline	GasSLX	Fleetline	GasSLX

ORION BUS INDUSTRIES(Cont'd.)

Orion V	050134509	010	85732
	050134510	010	85732
	050134513	010	85732
	050231505		010	85716	...
	680504		010	85716	...
	695347	010	85732
Orion VI (Low Floor)	060231508	010	85717
Orion VI (M Axle) with O.E.M. Number	060131507	-10	87016
	060131508	-10	87016
Orion VII - 30 ft Rear	070231527		01-	85729	...
Orion VII with O.E.M. Number	070131502	-10	87016
	070131506	-10	87016
	070231514		01-	85729	...
Models with O.E.M. Number	665596		010	85719	...
	680271		010	85714	...
	680274		010	85716	...
	680328	010	85717
	680378	010	85720
	695327	010	85732
	695343	010	85732
	695366	010	85732
	695389	-10	87016
	695420		01-	85729	...
	695421	-10	87016
	695440		01-	85729	...
	Additional O.E.M. Interchanges	010134501-4	010				85307
010134504-4		010				85715	
010134506-4		010				85717	
020273547-4		010				85719	
050134508		010				85718	
0501345-11		010				85718	
050231502-4		010				85716	
050231507		010				85716	
680091		010				85303 or 89422	
680102		010				85712	
680352		-10				85711	
680501		010				85714	
680502		010				85715	
680505		010				85717	
680506		010				85718	
690102		-10				85711	
97-9999-02635		010				85718	
97-9999-02636		010				85716	
A-4890		010				85712	
OB020570		-10				85711	
OB020764	010				85716		
OB3166657	010				85700		

OSHKOSH MOTORS

Mobile Home - ForeTravel	1583470		010	85051	...
Models with 16" Long Shock Absorber w/1" Mounting Pins	010	85303	89422	
Models with 3/4" Mounting Pins	010	83122	89406	

APPLICATION GUIDE - TRUCKS, TRAILERS, AND BUSES

Year Año Année	Model Modelo Modèle	OEM #	Front			Rear		
			Fleetline	GasSLX				

OSHKOSH MOTORS(Cont'd.)

	Models with Neway Air Suspension	90044448		OIO	85051	...
	Motor Homes with O.E.M. Number	1398980		83127	...	OIO	83127	...
		GBL654875		OIO	83117	...
		RW24285	OIO	83119
	V - Line Coach	1573280		OIO	83221	...
	Models with O.E.M. Number	12405F	OIO	85734
		12405F-1	OIO	85303	89422	
		1583470		OIO	85051	...
		3638112		OIO	G63183	...
		4036892	OIO	G63605
		5353054	OIO	85303	89422	
		5361994	OIO	85734
		651444		OIO	83221	...
		665040	OIO	85303	89422	
		690049	OIO	85303	89422	
		GBL654918	OIO	83118
		P117099		OIO	83120	...
		P117146	OIO	83118
	Additional O.E.M. Interchanges	12405FX1	OIO	85303 or 89422				
		1445910	OIO	85300 or 89419				
		1573270	OIO	83207 or 89407				
		1745500	OIO	89430				
		2173340	OIO	85303 or 89422				
		26228-A	OIO	83122 or 89406				
		2JD137	OIO	83119				
		40-0242	OIO	83312 or 89409				
		40-4845	OIO	85304				
		40-4951	OIO	85316 or 89426				
		40-5348	OIO	85058 or 89431				
		40-6967	OIO	85030 or 89440				
		665060	OIO	83122 or 89406				

OSHKOSH MOTORS CAB SHOCKS

	Models with Link Cabmate Model OKTP with O.E.M. Number	1202-0054	OIO	83021				
	Models with O.E.M. Number	2218640	OIO	83009				









OSTERLUND TRUCK

	Models with O.E.M. Number	59011	OIO	83214
		680117	OIO	85300	89419	
	Additional O.E.M. Interchanges	220-S5-10		OIO	85712	...

OTTAWA TRUCK

	Yard Tractor	59009		83217	...	OIO	83217	...
	Models with O.E.M. Number	59011	OIO	83214
		680117	OIO	85300	89419	
	Additional O.E.M. Interchanges	53540451	OIO	85300 or 89419				
		90013787	OIO	85310 or 89423				
		9007342	OIO	85303 or 89422				
	Yard Tractor	90027577	OIO	85720

APPLICATION GUIDE - TRUCKS, TRAILERS, AND BUSES

Year Año Année	Model Modelo Modèle	OEM #	Front		Rear	
						
						
			Fleetline	GasSLX	Fleetline	GasSLX

PACCAR

Additional Applications

TruckMaster Shock Stamping Number	665633	-10	85033	89427
-----------------------------------	--------	-----	-----	-----	-------	-------

PACIFIC TRUCK & TRAILER

Additional O.E.M. Interchanges	3178157C	507202C1	010	85735		
			010	85030 or 89440		

PAGE SUSPENSION

Model with LM-2000 Models Lift Axle Suspension	1080099	010	83203	89436
Model with Trailmaster Air Spring Suspension	1081933	010	83204	...
	A-2212	010	85029	...
Models with O.E.M. Number	665133	010	83203	89436
	665267	010	85029	...

PAI CORP

Models with O.E.M. Number	HSA-5067	010	85305
	HSA-5080	010	83221
	HSA-5095	010	83215

PEERLESS TRAILER

Models with Air Suspension	72-61	010	83125	...
Models with O.E.M. Number	120-1	010	83125	...

PETERBILT

210 Series

Models with Reyco 79KB Rear Steel Spring Suspension	16725-01	010	83221	...
---	----------	-----	-----	-----	-------	-----

220 Series

07 - 12	Models with 12,000 lb Front Axle	02-02738	010	85012	89413
		B71-6016	010	85012	89413
07 - 16	Models with 21,000 lb Reyco Spring Suspension	19495-01	010	83126	89440
07 - 16	Models with Hendrickson HAS - 210L or HAS - 230L Rear Air Suspension	60670-008	010	83123	89405
07 - 16	Models with Reyco 102AR (Standard) Rear Air Suspension	12887-01	010	85013	89414
		12887-02	010	85013	89414
07 - 16	Models with Reyco 79KB Rear Steel Spring Suspension	16725-01	010	83221	...

270 Series

Models with Woodhead Shock (Stamping Number ACHB 966)	ACHB966	-1-	83136	...
---	---------	-----	-----	-----	-------	-----





320 Series

87 - 16	Models with 12,000 lb to 14,600 lb Taperleaf Spring Suspension and Set Forward Front Axle.	02-01787	010	85062	89408
		02-02737	010	85062	89408
		B71-6009	010	85062	89408
01 - 17	Models with 18,000 lb to 23,000 lb Taperleaf Front Spring Suspension and Set Forward Front Axle.	02-02742	010	85062	89408
94 - 16	Models with Air Trac Suspension (38000 or 40000 lb)	B71-6011	010	85062	89408
		03-07421	-10	85311	89424
		C71-6002	-10	85311	89424
01 - 17	Models with Hendrickson HMX 400/460 Haulmax with 17.5" & 18.5" Saddle	60680-005	01-	83142	...

325 Series

- 16	Models with 21,000 lb Reyco Spring Suspension	19495-01	010	83126	89440
2016	Models with 8,000 lb Front Axle	B71-6004	010	85084	89460

APPLICATION GUIDE - TRUCKS, TRAILERS, AND BUSES

Year Año Année	Model Modelo Modèle	OEM #	Front		Rear	
			 Fleetline	 GasSLX	 Fleetline	 GasSLX

PETERBILT(Cont'd.)

330 Series(Cont'd.)

16 - 17	Models with 10,000 lb to 14,600 lb Taperleaf Springs and Set Back Front Axles	B71-6019	0 0	85989
95 - 16	Models with 12000 lb Set Back Front Axle	02-02738	0 0	85012	89413	
		B71-6016	0 0	85012	89413	
		B71-6016A	0 0	85012	89413	
- 17	Models with 21,000 lb Reyco Spring Suspension	19495-01		0 0	83126	89440
95 - 02	Models with Peterbilt 40000 lb Low Air Leaf Suspension	03-07423		- 0	85033	89427
03 - 16	Models with Peterbilt Low Air Leaf Suspension	03-08781		- -	85069	89455
		C71-1011		- -	85069	89455
		C71-1017		- -	85069	89455
- 17	Models with Reyco 79KB Rear Steel Spring Suspension	16725-01		0 0	83221	...
	Models with O.E.M. Number	02-03020	0 0	85910
		B71-6017	0 0	85910

335 Series

05 - 10	Models with 12000 lb Set Back Front Axle	02-02738	0 0	85012	89413	
		02-02741	0 0	85012	89413	
		B71-6016	0 0	85012	89413	
		B71-6016A	0 0	85012	89413	
05 - 10	Models with Air Trac Suspension (38000 or 40000 lb)	03-07421		- 0	85311	89424
05 - 10	Models with Peterbilt Low Air Leaf Suspension	03-08781		- -	85069	89455
		C71-1011		- -	85069	89455
		C71-1017		- -	85069	89455

337 Series

10 - 14	Models with 10,000 lb to 12,000 lb Front Axle	B71-6005	0 0	85084	89460	
15 - 17	Models with 10,000 lb to 14,600 lb Taperleaf Springs and Set Back Front Axles	B71-6019	0 0	85989
10 - 14	Models with 13,200 lb to 14,600 lb Front Axle	B71-6006	0 0	85084	89460	
10 - 13	Models with Peterbilt Air Trac Suspension (38000 or 40000 lb)	03-07421		- 0	85311	89424
		C71-6002		- 0	85311	89424
14 - 16	Models with Peterbilt Air Trac Suspension (38000 or 40000 lb)	C71-6003		- 0	85988	...
10 - 16	Models with Peterbilt Low Air Leaf Suspension (AG400L)	03-08781		- -	85069	89455
		C71-1011		- -	85069	89455
		C71-1017		- -	85069	89455
10 - 16	Models with Reyco 102AR (Standard) Rear Air Suspension	12887-01		0 0	85013	89414
		12887-02		0 0	85013	89414
10 - 16	Models with Reyco 79KB Rear Steel Spring Suspension	16725-01		0 0	83221	...





340 Series

07 - 10	Models with 12000 lb Set Back Front Axle	02-02738	0 0	85012	89413	
		02-02741	0 0	85012	89413	
13 - 14	Models with 12000 lb Set Back Front Axle	B71-6016	0 0	85012	89413	
		B71-6016A	0 0	85012	89413	
07 - 10	Models with Air Trac Suspension (38000 or 40000 lb)	03-07421		- 0	85311	89424

348 Series

12 - 13	Models with 10,000 lb to 12,000 lb Front Axle	B71-6005	0 0	85084	89460	
14 - 17	Models with 10,000 lb to 14,600 lb Taperleaf Springs and Set Back Front Axles	B71-6019	0 0	85989
14 - 17	Models with 20,000 lb Taperleaf Springs and Set Back Front Axles	B71-6020	0 0	85989
10 - 16	Models with Air Trac Suspension (38000 or 40000 lb)	03-07421		- 0	85311	89424
		C71-6002		- 0	85311	89424
08 - 16	Models with Hendrickson HMX 400/460 Haulmax with 17.5" & 18.5" Saddle	60680-005		0 -	83142	...

APPLICATION GUIDE - TRUCKS, TRAILERS, AND BUSES

Year Año Année	Model Modelo Modèle	OEM #	Front		Rear	
						
			Fleetline	GasSLX	Fleetline	GasSLX

PETERBILT(Cont'd.)

348 Series(Cont'd.)

15 - 16	Models with O.E.M. Number	B71-6012	010	85119
14 - 17	Models with Peterbilt Air Trac Suspension	C71-6003		-10	85988	...
- 16	Models with Reyco 102AR (Standard) Rear Air Suspension	12887-01		010	85013	89414
		12887-02		010	85013	89414
- 17	Models with Reyco 79KB Rear Steel Spring Suspension	16725-01		010	83221	...

349 Series

	349 Conventional Models with 12000 lb capacity	02-00376	010	85302	89420	
		02-00495	010	85302	89420	
		02-02736	010	85302	89420	

353 Series

	353 Conventional Models with 12000 lb capacity	02-00376	010	85302	89420	
		02-00495	010	85302	89420	
		02-02736	010	85302	89420	

357 Series

	Conventional Models with Front Air Suspension and Set Back Front Axle.	02-02739	010	85013	89414	
	Conventional Models with Front Air Suspension and without Set Back Front Axle.	02-02740	010	85036	89405	
	Conventional Models with Spring Suspension and with Set Back Front Axle.	02-02738	010	85012	89413	
		02-02741	010	85012	89413	
13 - 14	Conventional Models with Spring Suspension and with Set Back Front Axle.	B71-6016	010	85012	89413	
		B71-6016A	010	85012	89413	
	Models with 12,000 lb to 14,600 lb Taperleaf Spring Suspension and Set Forward Front Axle.	02-02737	010	85062	89408	
		B71-6007	010	85062	89408	
		B71-6009	010	85062	89408	
	Models with 18,000 lb to 23,000 lb Taperleaf Front Spring Suspension and Set Forward Front Axle.	02-02742	010	85062	89408	
	Models with 18,000 lb to 23,000 lb Taperleaf Spring Suspension and Set Forward Axles	B71-6011	010	85062	89408	
- 11/82	Models with Air Trac Suspension (38000 or 40000 lb)	03-04176		010	85308	89422
87 - 07	Models with Air Trac Suspension (38000 or 40000 lb)	03-07421		-10	85311	89424
		Models with Air Track Tandem with TRD8000 Pusher Axle	03-08350		-10	85343
			C71-6004		-10	85343
	Models with Chalmers 40,000 lb Rear Suspension	665174		010	85060	...
		800670		010	85060	...
	Models with Neway ARD 125/244-8 Models Rear Air Suspension	90044011		010	85004	...
- 03	Models with Peterbilt Low Air Leaf Suspension	03-07423		-10	85033	89427
		665633		-10	85033	89427
03 -	Models with Peterbilt Low Air Leaf Suspension	03-08781		-1-	85069	89455
		C71-1017		-1-	85069	89455





359 Series

	359 Conventional Models with 12000 lb capacity	02-00376	010	85302	89420	
		02-00495	010	85302	89420	
		02-02736	010	85302	89420	

362 Series

	C.O.E. Models with 12000 lb capacity	02-02736	010	85302	89420	
	C.O.E. Models with 14600 lb Taper Leaf Springs and Set Back Front Axle	02-02740	010	85036	89405	
	C.O.E. Models with Progressive Springs	02-02738	010	85012	89413	
13 - 14	C.O.E. Models with Progressive Springs	B71-6016	010	85012	89413	

APPLICATION GUIDE - TRUCKS, TRAILERS, AND BUSES

Year Año Année	Model Modelo Modèle	OEM #	Front		Rear	
			 Fleetline	 GasSLX	 Fleetline	 GasSLX

PETERBILT(Cont'd.)

362 Series(Cont'd.)

13 - 14	C.O.E. Models with Progressive Springs	B71-6016A	010	85012	89413	
	C.O.E. Models without Set Back Front Axle	02-00376	010	85302	89420	
		02-00495	010	85302	89420	
- 11/82	Models with Air Trac Suspension (38000 or 40000 lb)	03-04176		010	85308	89422
81 - 06	Models with Air Trac Suspension (38000 or 40000 lb)	03-07421		-10	85311	89424
	Models with Chalmers 40,000 lb Rear Suspension	665174		010	85060	...
		800670		010	85060	...
	Models with Neway ARD 125/244-8 Models Rear Air Suspension	90044011		010	85004	...
- 03	Models with Peterbilt Low Air Leaf Suspension	03-07423		-10	85033	89427
		665633		-10	85033	89427
03 -	Models with Peterbilt Low Air Leaf Suspension	03-08781		-1-	85069	89455
		C71-1017		-1-	85069	89455





365 Series

08 - 17	Models with 12,000 lb to 14,600 lb Taperleaf Spring Suspension and Set Forward Front Axle.	B71-6007	010	85062	89408	
08 - 15	Models with 12,000 lb to 16,000 lb Taperleaf Front Suspension (Set-Back Axle)	B71-6002	010	85012	89413	
		B71-6013	010	85012	89413	
08 - 17	Models with 18,000 lb to 23,000 lb Taperleaf Front Spring Suspension and Set Forward Front Axle.	02-02742	010	85062	89408	
		B71-6011	010	85062	89408	
08 - 16	Models with Air Trac Suspension (38000 or 40000 lb)	03-07421		-10	85311	89424
		C71-6002		-10	85311	89424
- 17	Models with Chalmers 40,000 lb Rear Suspension	665174		010	85060	...
		800670		010	85060	...
08 - 17	Models with FlexAir Suspension (38000 lb)	C71-1002		010	85067	89451
		C71-1016		010	85067	89451
		C71-6000		010	85067	89451
		C71-6015		010	85067	89451
08 - 17	Models with Hendrickson HMX 400/460 Haulmax with 16.5" Saddle	60680-004		01-	83143	...
08 - 17	Models with Hendrickson HMX 400/460 Haulmax with 17.5" & 18.5" Saddle	60680-005		01-	83142	...
- 16	Models with Neway ADZ Rear Suspension	471700004423		010	85109	...
		90045605		010	85109	...
14 - 17	Models with Peterbilt Air Leaf Suspension	C71-6003		-10	85988	...
08 - 17	Models with Peterbilt Low Air Leaf Suspension	03-08781		-1-	85069	89455
		C71-1011		-1-	85069	89455
		C71-1017		-1-	85069	89455
		C71-6005		-1-	85069	89455
08 - 12	Models with Quadraflex 4 Spring Rear Suspension	03-07420		-1-	85336	...

367 Series

08 - 16	Models with 10,000 lb to 16,000 lb Taperleaf Front Spring Suspension and with Set Back Front Axle.	B71-6002	010	85012	89413	
		B71-6016	010	85012	89413	
14 - 17	Models with 12,000 lb to 14,600 lb Taperleaf Spring Suspension and Set Forward Front Axle.	B71-6009	010	85062	89408	
08 - 17	Models with 18,000 lb to 23,000 lb Taperleaf Front Spring Suspension and Set Forward Front Axle.	02-02742	010	85062	89408	
		B71-6007	010	85062	89408	
		B71-6011	010	85062	89408	
08 - 17	Models with Air Trac Suspension (38000 or 40000 lb)	03-07421		-10	85311	89424
		C71-6002		-10	85311	89424

APPLICATION GUIDE - TRUCKS, TRAILERS, AND BUSES

Year Año Année	Model Modelo Modèle	OEM #	Front		Rear	
						
			Fleetline	GasSLX	Fleetline	GasSLX

PETERBILT(Cont'd.)

367 Series(Cont'd.)

	Models with Air Track Tri Drive Suspension	03-08350 C71-6004		-10	85343	...
	Models with Chalmers 40,000 lb Rear Suspension	665174 800670		010	85060	...
08 - 17	Models with FlexAir Suspension (38000 lb)	C71-1002 C71-1016 C71-6000 C71-6015		010	85067	89451
08 - 17	Models with Hendrickson HMX 400/460 Haulmax with 16.5" Saddle	60680-004		01-	83143	...
08 - 17	Models with Hendrickson HMX 400/460 Haulmax with 17.5" & 18.5" Saddle	60680-005		01-	83142	...
- 16	Models with Neway ADZ Rear Suspension	471700004423 90045605		010	85109	...
08 -	Models with Peterbilt Low Air Leaf Suspension	03-08781 C71-1011 C71-1017		-1-	85069	89455
08 - 10	Models with Quadraflex 4 Spring Rear Suspension	03-07420		-1-	85336	...





372 Series

- 93	C.O.E. Models with Front Air Suspension	02-02739	010	85013	89414	
- 93	C.O.E. Models with Front Spring Suspension	02-02738 B71-6016 B71-6016A	010 010 010	85012	89413	
- 11/82	Models with Air Trac Suspension (38000 or 40000 lb)	03-04176		010	85308	89422
89 - 93	Models with Air Trac Suspension (38000 or 40000 lb)	03-07421		-10	85311	89424
- 93	Models with Chalmers 40,000 lb Rear Suspension	665174 800670		010	85060	...
- 93	Models with Neway ARD 125/244-8 Models Rear Air Suspension	90044011		010	85004	...
- 93	Models with Peterbilt Low Air Leaf Suspension	03-07423 665633		-10	85033	89427

375 Series

	Conventional Models with Front Air Suspension and Set Back Front Axle.	02-02739	010	85013	89414	
	Conventional Models with Front Air Suspension and without Set Back Front Axle.	02-02740	010	85036	89405	
	Conventional Models with Spring Suspension and with Set Back Front Axle.	02-02738 02-02741	010 010	85012	89413	
13 - 14	Conventional Models with Spring Suspension and with Set Back Front Axle.	B71-6016 B71-6016A	010 010	85012	89413	
	Models with 12,000 lb to 14,600 lb Taperleaf Spring Suspension and Set Forward Front Axle.	02-02737 B71-6007 B71-6009	010 010 010	85062	89408	
	Models with 18,000 lb to 23,000 lb Taperleaf Front Spring Suspension and Set Forward Front Axle.	02-02742	010	85062	89408	
	Models with 18,000 lb to 23,000 lb Taperleaf Spring Suspension and Set Forward Axles	B71-6011	010	85062	89408	
- 11/82	Models with Air Trac Suspension (38000 or 40000 lb)	03-04176		010	85308	89422
87 - 96	Models with Air Trac Suspension (38000 or 40000 lb)	03-07421		-10	85311	89424
	Models with Chalmers 40,000 lb Rear Suspension	665174 800670		010	85060	...

APPLICATION GUIDE - TRUCKS, TRAILERS, AND BUSES

Year Año Année	Model Modelo Modèle	OEM #	Front		Rear	
			 Fleetline	 GasSLX	 Fleetline	 GasSLX

PETERBILT(Cont'd.)

375 Series(Cont'd.)

	Models with Neway ARD 125/244-8 Models Rear Air Suspension	90044011		010	85004	...
- 03	Models with Peterbilt Low Air Leaf Suspension	03-07423		-10	85033	89427
		665633		-10	85033	89427
03 -	Models with Peterbilt Low Air Leaf Suspension	03-08781		-1-	85069	89455
		C71-1017		-1-	85069	89455





376 Series

	Conventional Models with Front Air Suspension and Set Back Front Axle.	02-02739	010	85013	89414	
	Conventional Models with Front Air Suspension and without Set Back Front Axle.	02-02740	010	85036	89405	
	Conventional Models with Spring Suspension and with Set Back Front Axle.	02-02738	010	85012	89413	
		02-02741	010	85012	89413	
		B71-6016	010	85012	89413	
		B71-6016A	010	85012	89413	
	Models with 12,000 lb to 14,600 lb Taperleaf Spring Suspension and Set Forward Front Axle.	02-02737	010	85062	89408	
		B71-6007	010	85062	89408	
		B71-6009	010	85062	89408	
	Models with 18,000 lb to 23,000 lb Taperleaf Front Spring Suspension and Set Forward Front Axle.	02-02742	010	85062	89408	
	Models with 18,000 lb to 23,000 lb Taperleaf Spring Suspension and Set Forward Axles	B71-6011	010	85062	89408	
- 11/82	Models with Air Trac Suspension (38000 or 40000 lb)	03-04176		010	85308	89422
11/ 82 -	Models with Air Trac Suspension (38000 or 40000 lb)	03-07421		-10	85311	89424
	Models with Chalmers 40,000 lb Rear Suspension	665174		010	85060	...
		800670		010	85060	...
	Models with Neway ARD 125/244-8 Models Rear Air Suspension	90044011		010	85004	...
- 03	Models with Peterbilt Low Air Leaf Suspension	03-07423		-10	85033	89427
		665633		-10	85033	89427
03 -	Models with Peterbilt Low Air Leaf Suspension	03-08781		-1-	85069	89455
		C71-1017		-1-	85069	89455

377 Series

	Conventional Models with Front Air Suspension and Set Back Front Axle.	02-02739	010	85013	89414	
	Conventional Models with Front Air Suspension and without Set Back Front Axle.	02-02740	010	85036	89405	
	Conventional Models with Spring Suspension and with Set Back Front Axle.	02-02738	010	85012	89413	
		02-02741	010	85012	89413	
	Models with 12,000 lb to 14,600 lb Taperleaf Spring Suspension and Set Forward Front Axle.	02-02737	010	85062	89408	
		B71-6007	010	85062	89408	
		B71-6009	010	85062	89408	
	Models with 18,000 lb to 23,000 lb Taperleaf Front Spring Suspension and Set Forward Front Axle.	02-02742	010	85062	89408	
	Models with 18,000 lb to 23,000 lb Taperleaf Spring Suspension and Set Forward Axles	B71-6011	010	85062	89408	
- 11/82	Models with Air Trac Suspension (38000 or 40000 lb)	03-04176		010	85308	89422
11/ 82 -	Models with Air Trac Suspension (38000 or 40000 lb)	03-07421		-10	85311	89424
	Models with Chalmers 40,000 lb Rear Suspension	665174		010	85060	...
		800670		010	85060	...
	Models with Neway ARD 125/244-8 Models Rear Air Suspension	90044011		010	85004	...

APPLICATION GUIDE - TRUCKS, TRAILERS, AND BUSES

Year Año Année	Model Modelo Modèle	OEM #	Front		Rear	
						
			Fleetline	GasSLX	Fleetline	GasSLX

PETERBILT(Cont'd.)

377 Series(Cont'd.)

- 03	Models with Peterbilt Low Air Leaf Suspension	03-07423	-10	85033	89427
		665633	-10	85033	89427





378 Series

	Conventional Models with Front Air Suspension and Set Back Front Axle.	02-02739	010	85013	89414	
	Conventional Models with Front Air Suspension and without Set Back Front Axle.	02-02740	010	85036	89405	
- 07	Conventional Models with Spring Suspension and with Set Back Front Axle.	02-02738	010	85012	89413	
		02-02741	010	85012	89413	
		B71-6016	010	85012	89413	
		B71-6016A	010	85012	89413	
	Models with 12,000 lb to 14,600 lb Taperleaf Spring Suspension and Set Forward Front Axle.	02-02737	010	85062	89408	
		B71-6007	010	85062	89408	
		B71-6009	010	85062	89408	
	Models with 18,000 lb to 23,000 lb Taperleaf Front Spring Suspension and Set Forward Front Axle.	02-02742	010	85062	89408	
	Models with 18,000 lb to 23,000 lb Taperleaf Spring Suspension and Set Forward Axles	B71-6011	010	85062	89408	
- 11/82	Models with Air Trac Suspension (38000 or 40000 lb)	03-04176		010	85308	89422
11/ 82 -	Models with Air Trac Suspension (38000 or 40000 lb)	03-07421		-10	85311	89424
	Models with Chalmers 40,000 lb Rear Suspension	665174		010	85060	...
		800670		010	85060	...
99 - 07	Models with FlexAir Suspension (38000 lb)	C71-1002		010	85067	89451
		C71-6000		010	85067	89451
	Models with Neway ARD 125/244-8 Models Rear Air Suspension	90044011		010	85004	...
- 03	Models with Peterbilt Low Air Leaf Suspension	03-07423		-10	85033	89427
		665633		-10	85033	89427
03 -	Models with Peterbilt Low Air Leaf Suspension	03-08781		-1-	85069	89455
		C71-1017		-1-	85069	89455

379 Series

	Conventional Models with Front Air Suspension and Set Back Front Axle.	02-02739	010	85013	89414	
	Conventional Models with Front Air Suspension and without Set Back Front Axle.	02-02740	010	85036	89405	
- 09	Conventional Models with Spring Suspension and with Set Back Front Axle.	02-02738	010	85012	89413	
		02-02741	010	85012	89413	
		B71-6016	010	85012	89413	
		B71-6016A	010	85012	89413	
	Models with 12,000 lb to 14,600 lb Taperleaf Spring Suspension and Set Forward Front Axle.	02-02737	010	85062	89408	
		B71-6007	010	85062	89408	
		B71-6009	010	85062	89408	
	Models with 18,000 lb to 23,000 lb Taperleaf Front Spring Suspension and Set Forward Front Axle.	02-02742	010	85062	89408	
	Models with 18,000 lb to 23,000 lb Taperleaf Spring Suspension and Set Forward Axles	B71-6011	010	85062	89408	
- 11/82	Models with Air Trac Suspension (38000 or 40000 lb)	03-04176		010	85308	89422
11/ 82 -	Models with Air Trac Suspension (38000 or 40000 lb)	03-07421		-10	85311	89424
	Models with Chalmers 40,000 lb Rear Suspension	665174		010	85060	...
		800670		010	85060	...
99 - 07	Models with FlexAir Suspension (38000 lb)	C71-1002		010	85067	89451
		C71-6000		010	85067	89451

APPLICATION GUIDE - TRUCKS, TRAILERS, AND BUSES

Year Año Année	Model Modelo Modèle	OEM #	Front		Rear	
						
			Fleetline	GasSLX	Fleetline	GasSLX

PETERBILT(Cont'd.)

379 Series(Cont'd.)

	Models with Neway ARD 125/244-8 Models Rear Air Suspension	90044011	010	85004	...
- 03	Models with Peterbilt Low Air Leaf Suspension	03-07423	-10	85033	89427
		665633	-10	85033	89427
03 -	Models with Peterbilt Low Air Leaf Suspension	03-08781	-1-	85069	89455
		C71-1017	-1-	85069	89455

382 Series

11 -	Models with 10,000 lb to 12,000 lb Front Axle	B71-6005	010	85084	89460
11 -	Models with 12,000 lb to 14,600 lb Taperleaf Spring Suspension and Set Forward Front Axle.	02-02737	010	85062	89408
		B71-6009	010	85062	89408
11 - 16	Models with Air Trac Suspension (38000 or 40000 lb)	03-07421	-10	85311	89424
		C71-6002	-10	85311	89424
11 - 17	Models with FlexAir Suspension (38000 lb)	C71-1002	010	85067	89451
		C71-1016	010	85067	89451
		C71-6000	010	85067	89451
		C71-6015	010	85067	89451
11 -	Models with Peterbilt Low Air Leaf Suspension	03-08781	-1-	85069	89455
		C71-1011	-1-	85069	89455
		C71-1017	-1-	85069	89455
11 -	Models with Quadraflex 4 Spring Rear Suspension	03-07420	-1-	85336	...
11 -	Models with Reyco 102AR (Standard) Rear Air Suspension	12887-01	010	85013	89414
		12887-02	010	85013	89414
11 -	Models with Reyco 79KB Rear Steel Spring Suspension	16725-01	010	83221	...





384 Series

08 - 12	Models with 12,000 lb to 14,600 lb Taperleaf Spring Suspension and Set Forward Front Axle.	02-02737	010	85062	89408
13 - 14	Models with 12,000 lb to 14,600 lb Taperleaf Spring Suspension and Set Forward Front Axle. (Std Duty) (Heavy Duty)	B71-6009	010	83219	89408
		B71-6009	010	85062	89408
		B71-6009	010	85062	89408
08 - 16	Models with Air Trac Suspension (38000 or 40000 lb)	03-07421	-10	85311	89424
		C71-6002	-10	85311	89424
09 - 17	Models with FlexAir Suspension (38000 lb)	C71-1002	010	85067	89451
		C71-1016	010	85067	89451
		C71-6000	010	85067	89451
		C71-6015	010	85067	89451
08 -	Models with Peterbilt Low Air Leaf Suspension	03-08781	-1-	85069	89455
		C71-1011	-1-	85069	89455
		C71-1017	-1-	85069	89455
08 -	Models with Quadraflex 4 Spring Rear Suspension	03-07420	-1-	85336	...

385 Series

- 07	Conventional Models with Spring Suspension and with Set Back Front Axle.	02-02738	010	85012	89413
		02-02741	010	85012	89413
		B71-6016	010	85012	89413
		B71-6016A	010	85012	89413
- 07	Models with 12,000 lb to 14,600 lb Taperleaf Spring Suspension and Set Forward Front Axle.	02-02737	010	85062	89408
		B71-6007	010	85062	89408
		B71-6009	010	85062	89408
- 07	Models with 18,000 lb to 23,000 lb Taperleaf Front Spring Suspension and Set Forward Front Axle.	02-02742	010	85062	89408

APPLICATION GUIDE - TRUCKS, TRAILERS, AND BUSES

Year Año Année	Model Modelo Modèle	OEM #	Front		Rear	
						
					Fleetline	GasSLX

PETERBILT(Cont'd.)

385 Series(Cont'd.)

- 07	Models with 18,000 lb to 23,000 lb Taperleaf Front Spring Suspension and Set Forward Front Axle.	B71-6011	0 0	85062	89408	
- 11/82	Models with Air Trac Suspension	03-04176		0 0	85308	89422
95 - 08	Models with Air Trac Suspension	03-07421		- 0	85311	89424
	Models with Chalmers 40,000 lb Rear Suspension	665174		0 0	85060	...
		800670		0 0	85060	...
95 - 08	Models with FlexAir Suspension (38000 lb)	C71-1002		0 0	85067	89451
		C71-6000		0 0	85067	89451
	Models with Neway ARD 125/244-8 Models Rear Air Suspension	90044011		0 0	85004	...
- 03	Models with Peterbilt Low Air Leaf Suspension	03-07423		- 0	85033	89427
		665633		- 0	85033	89427
04 - 07	Models with Peterbilt Low Air Leaf Suspension	03-08781		- -	85069	89455
		C71-1017		- -	85069	89455
	Models with Quadraflex 4 Spring Rear Suspension	03-07420		- -	85336	...





386 Series

06 -	Conventional Models with Front Air Suspension and Set Back Front Axle.	02-02739	0 0	85013	89414	
06 -	Conventional Models with Front Air Suspension and without Set Back Front Axle.	02-02740	0 0	85036	89405	
06 -	Conventional Models with Spring Suspension and with Set Back Front Axle.	02-02738	0 0	85012	89413	
		02-02741	0 0	85012	89413	
		02-04010	0 0	85012	89413	
		B71-6018	0 0	85012	89413	
13 - 14	Conventional Models with Spring Suspension and with Set Back Front Axle.	B71-6016	0 0	85012	89413	
		B71-6016A	0 0	85012	89413	
06 -	Models with 12,000 lb to 14,600 lb Taperleaf Spring Suspension and Set Forward Front Axle.	B71-6007	0 0	85062	89408	
06 - 12	Models with 12,000 lb to 14,600 lb Taperleaf Spring Suspension and Set Forward Front Axle.	02-02737	0 0	85062	89408	
		B71-6009	0 0	85062	89408	
06 -	Models with 18,000 lb to 23,000 lb Taperleaf Front Spring Suspension and Set Forward Front Axle.	02-02742	0 0	85062	89408	
		B71-6011	0 0	85062	89408	
06 - 17	Models with FlexAir Suspension (38000 lb)	C71-1002		0 0	85067	89451
		C71-1016		0 0	85067	89451
		C71-6000		0 0	85067	89451
		C71-6015		0 0	85067	89451
06 - 16	Models with Peterbilt Air Leaf Suspension	03-07421		- 0	85311	89424
		C71-6002		- 0	85311	89424
06 -	Models with Peterbilt Low Air Leaf Suspension	03-08781		- -	85069	89455
		C71-1011		- -	85069	89455
		C71-1017		- -	85069	89455

387 Series

- 09	Conventional Models with Front Air Suspension and Set Back Front Axle.	02-02739	0 0	85013	89414	
- 09	Conventional Models with Front Air Suspension and without Set Back Front Axle.	02-02740	0 0	85036	89405	
- 11	Conventional Models with Spring Suspension and with Set Back Front Axle.	02-02738	0 0	85012	89413	
		02-02741	0 0	85012	89413	
		02-04010	0 0	85012	89413	
		B71-6016	0 0	85012	89413	

APPLICATION GUIDE - TRUCKS, TRAILERS, AND BUSES

Year Año Année	Model Modelo Modèle	OEM #	Front		Rear	
			 Fleetline	 GasSLX	 Fleetline	 GasSLX

PETERBILT(Cont'd.)

387 Series(Cont'd.)

- 11	Conventional Models with Spring Suspension and with Set Back Front Axle.	B71-6016A	010	85012	89413	
		B71-6018	010	85012	89413	
- 11	Models with 12,000 lb to 14,600 lb Taperleaf Spring Suspension and Set Forward Front Axle.	02-02737	010	85062	89408	
		B71-6007	010	85062	89408	
		B71-6009	010	85062	89408	
- 11	Models with 18,000 lb to 23,000 lb Taperleaf Front Spring Suspension and Set Forward Front Axle.	02-02742	010	85062	89408	
		B71-6011	010	85062	89408	
00 - 11	Models with FlexAir Suspension (38000 lb)	C71-1002		010	85067	89451
		C71-6000		010	85067	89451
- 11	Models with Peterbilt Air Leaf Suspension	03-07421		-10	85311	89424
- 03	Models with Peterbilt Low Air Leaf Suspension	03-07423		-10	85033	89427
		665633		-10	85033	89427
03 - 11	Models with Peterbilt Low Air Leaf Suspension	03-08781		-1-	85069	89455
		C71-1011		-1-	85069	89455
		C71-1017		-1-	85069	89455





388 Series

08 - 16	Conventional Models with Front Air Suspension and Set Back Front Axle.	02-02739	010	85013	89414	
		85013A0C	010	85013	89414	
08 -	Conventional Models with Front Air Suspension and without Set Back Front Axle.	02-02740	010	85036	89405	
08 -	Conventional Models with Spring Suspension and with Set Back Front Axle.	02-04010	010	85012	89413	
		B71-6018	010	85012	89413	
08 - 17	Models with 12,000 lb to 14,600 lb Taperleaf Spring Suspension and Set Forward Front Axle. (Std Duty)	B71-6007	010	85062	89408	
		B71-6009	010	85062	89408	
		B71-6009	010	83219	89408	
08 - 17	Models with 18,000 lb to 23,000 lb Taperleaf Front Spring Suspension and Set Forward Front Axle.	02-02742	010	85062	89408	
		B71-6011	010	85062	89408	
08 - 17	Models with Air Trac Suspension (38000 or 40000 lb)	03-07421		-10	85311	89424
		C71-6002		-10	85311	89424
08 - 17	Models with FlexAir Suspension (38000 lb)	C71-1002		010	85067	89451
		C71-1016		010	85067	89451
		C71-6000		010	85067	89451
		C71-6015		010	85067	89451
14 -	Models with O.E.M. Number	C71-6003		-10	85988	...
08 - 14	Models with Peterbilt Air Leaf Suspension	03-07421		-10	85311	89424
		03-07421PLUS		-10	85311	89424
08 - 17	Models with Peterbilt Low Air Leaf Suspension	03-08781		-1-	85069	89455
		C71-1011		-1-	85069	89455
		C71-1017		-1-	85069	89455

389 Series

08 -	Conventional Models with Front Air Suspension and Set Back Front Axle.	02-02739	010	85013	89414	
08 -	Conventional Models with Front Air Suspension and without Set Back Front Axle.	02-02740	010	85036	89405	
08 -	Conventional Models with Spring Suspension and with Set Back Front Axle.	02-04010	010	85012	89413	
		B71-6018	010	85012	89413	

APPLICATION GUIDE - TRUCKS, TRAILERS, AND BUSES

Year Año Année	Model Modelo Modèle	OEM #	Front		Rear	
						
			Fleetline	GasSLX	Fleetline	GasSLX

PETERBILT(Cont'd.)

389 Series(Cont'd.)

08 -	Models with 12,000 lb to 14,600 lb Taperleaf Spring Suspension and Set Forward Front Axle.	B71-6007	010	85062	89408	
10 - 13	Models with 12,000 lb to 14,600 lb Taperleaf Spring Suspension and Set Forward Front Axle.	02-02737	010	85062	89408	
		B71-6009	010	85062	89408	
08 -	Models with 18,000 lb to 23,000 lb Taperleaf Front Spring Suspension and Set Forward Front Axle.	02-02742	010	85062	89408	
		B71-6011	010	85062	89408	
14 - 16	Models with Air Trac Suspension (38000 or 40000 lb)	C71-6002		-10	85311	89424
08 - 17	Models with FlexAir Suspension (38000 lb)	C71-1002		010	85067	89451
		C71-1016		010	85067	89451
		C71-6000		010	85067	89451
		C71-6015		010	85067	89451
14 - 16	Models with Neway ADZ Rear Suspension	471700004423		010	85109	...
		90045605		010	85109	...
08 -	Models with Peterbilt Air Leaf Suspension	03-07421		-10	85311	89424
08 -	Models with Peterbilt Low Air Leaf Suspension	03-08781		-1-	85069	89455
		C71-1011		-1-	85069	89455
		C71-1017		-1-	85069	89455

567 Series

14 - 17	Models with 10,000 lb to 14,600 lb Taperleaf Springs and Set Back Front Axles	B71-6019	010	85989
14 - 17	Models with 12,000 lb to 14,600 lb Taperleaf Spring Suspension and Set Forward Front Axle.	B71-6009	010	85062	89408	
14 - 17	Models with 18,000 lb to 23,000 lb Taperleaf Spring Suspension and Set Forward Axles	B71-6011	010	85062	89408	
14 - 17	Models with 20,000 lb Taperleaf Springs and Set Back Front Axles	B71-6020	010	85989
14 - 17	Models with Air Trac Suspension (38000 or 40000 lb)	C71-6002		-10	85311	89424
14 - 17	Models with Chalmers 40,000 lb Rear Suspension	665174		010	85060	...
		800670		010	85060	...
14 - 17	Models with FlexAir Suspension (38000 lb)	C71-1016		010	85067	89451
		C71-6015		010	85067	89451
14 - 17	Models with Hendrickson HMX 400/460 Haulmax with 16.5" Saddle	60680-004		01-	83143	...
14 - 17	Models with Hendrickson HMX 400/460 Haulmax with 17.5" & 18.5" Saddle	60680-005		01-	83142	...
14 - 17	Models with Neway ADZ Rear Suspension	471700004423		010	85109	...
		90045605		010	85109	...
14 - 17	Models with Peterbilt Air Trac Suspension (38000 or 40000 lb)	C71-6003		-10	85988	...
14 - 17	Models with Peterbilt Low Air Leaf Suspension	C71-1017		-1-	85069	89455
		C71-6005		-1-	85069	89455

579 Series

13 - 16	Day Cab Models with 10,000 lb to 12,000 lb Front Axle	B71-6005	010	85084	89460	
13 - 17	Models with 10,000 lb to 14,600 lb Taperleaf Springs and Set Back Front Axles	B71-6019	010	85989
13 -	Models with 12,000 lb to 14,600 lb Taperleaf Spring Suspension and Set Forward Front Axle.	02-02737	010	85062	89408	
		B71-6009	010	85062	89408	
13 - 16	Models with Air Trac Suspension (38000 or 40000 lb)	03-07421		-10	85311	89424
		C71-6002		-10	85311	89424
13 - 17	Models with FlexAir Suspension (38000 lb)	C71-1002		010	85067	89451
		C71-1016		010	85067	89451
		C71-6000		010	85067	89451
		C71-6015		010	85067	89451

APPLICATION GUIDE - TRUCKS, TRAILERS, AND BUSES

Year Año Année	Model Modelo Modèle	OEM #	Front			Rear		
			Fleetline	GasSLX				

PETERBILT(Cont'd.)

579 Series(Cont'd.)

13 -	Models with Peterbilt Front Air Leaf Suspension	B71-6000	OIO	85959
13 - 16	Models with Peterbilt Low Air Leaf Suspension	03-08781		- -	85069	89455
		C71-1011		- -	85069	89455
		C71-1017		- -	85069	89455
13 -	Models with Reyco 102AR (Standard) Rear Air Suspension	12887-01		OIO	85013	89414
		12887-02		OIO	85013	89414
13 -	Models with Reyco 79KB Rear Steel Spring Suspension	16725-01		OIO	83221	...









587 Series

11 - 16	Models with 12,000 lb to 14,600 lb Taperleaf Spring Suspension and Set Forward Front Axle.	02-02737	OIO	85062	89408	
		B71-6009	OIO	85062	89408	
11 - 16	Models with Air Trac Suspension (38000 or 40000 lb)	03-07421		- O	85311	89424
		C71-6002		- O	85311	89424
11 - 17	Models with FlexAir Suspension (38000 lb)	C71-1002		OIO	85067	89451
		C71-1016		OIO	85067	89451
		C71-6000		OIO	85067	89451
		C71-6015		OIO	85067	89451
11 - 13	Models with Peterbilt Front Air Leaf Suspension	B71-6000	OIO	85959	
11 - 17	Models with Peterbilt Low Air Leaf Suspension	03-08781		- -	85069	89455
		C71-1011		- -	85069	89455
		C71-1017		- -	85069	89455
11 -	Models with Quadraflex 4 Spring Rear Suspension	03-07420		- -	85336	...
11 -	Models with Reyco 102AR (Standard) Rear Air Suspension	12887-01		OIO	85013	89414
		12887-02		OIO	85013	89414
11 -	Models with Reyco 79KB Rear Steel Spring Suspension	16725-01		OIO	83221	...

Additional Applications

	OE PLUS Shock Stamping Number	02-02736PLUS	OIO	85302	89420	
		02-02737PLUS	OIO	85062	89408	
		02-02738PLUS	OIO	85012	89413	
		02-02739PLUS	OIO	85013	89414	
		03-04176PLUS		OIO	85308	89422
		03-06084PLUS		- O	85033	89427
		03-07421PLUS		- O	85311	89424
		03-07423PLUS		- O	85033	89427
		10-12032-002PLUS	OIO	85320	89429	
		10-12542-000PLUS	OIO	85901
		16-13947-000PLUS		- O	85319	89428
		2018987C1PLUS		OIO	85003	89411
		47902-13PLUS		OIO	83122	89406
		60670-005PLUS		OIO	83137	...
		60670-008PLUS		OIO	83123	89405
		665565PLUS		OIO	85007	89412
		671962PLUS		O -	85936	89456
		70701PLUS		- -	85900	...
		8086053PLUS		OIO	85047	89435
		90044025PLUS	OIO	83209	89414	
		90044089PLUS		OIO	83124	89407
		B71-6015	OIO	85012	89413	
		C71-1002PLUS		OIO	85067	89451
		C71-1011PLUS		- -	85069	89455
		K374-26PLUS	OIO	85001	89410	

APPLICATION GUIDE - TRUCKS, TRAILERS, AND BUSES









Year Año Année	Model Modelo Modèle	OEM #	Front		Rear	
						
						
			Fleetline	GasSLX	Fleetline	GasSLX

PETERBILT(Cont'd.)

Additional Applications(Cont'd.)

	OE PLUS Shock Stamping Number	K374-28PLUS	OIO	85314	89425	
		K374-29PLUS	- -	85310	89423	
		K374-33PLUS	OIO	83312	89409	
	TruckMaster Shock Stamping Number	665632	OIO	85013	89414	
		665783	OIO	83123	89405	
		665784	OIO	83122	89406	
		665785	OIO	83137	...	
		665844	- -	85069	89455	
		665918	- -	85900	...	
		665926	OIO	85047	89435	
		665927	OIO	85901	
		665928	OIO	85062	89408	
		665930	OIO	85001	89410	
		665931	OIO	83312	89409	
		665932	OIO	85012	89413	
		665950	- -	85902	...	
		671052	OIO	85070	89459	
		671654	O -	85936	89456	
		671699	O -	85937	...	
		671794	OIO	85067	89451	
		680237	OIO	85303	89422	
		680239	- -	85310	89423	
		680240	OIO	85302	89420	
		680242	OIO	85308	89422	
		680253	OIO	85314	89425	
		680261	OIO	85062	89408	
		680279	OIO	83209	89414	
		680280	OIO	85906	89407	
		680281	OIO	85003	89411	
		680283	O -	83353	
		680303	OIO	85007	89412	
		680425	OIO	85320	89429	
		680435	- O	85033	89427	
		680473	- O	85319	89428	
			Models with O.E.M. Number	02-01759	OIO	83312	89409	...
02-01890	OIO			85012	89413	
02-02061	OIO			85013	89414	
02-02142	OIO			85036	89405	
02-02225	OIO			85012	89413	
03-01635	OIO	85308	89422	
03-04629	- O	85311	89424	
03-05106	- O	85033	89427	
03-05384	- O	85033	89427	
03-06084	- O	85033	89427	
03-07281	- O	85311	89424	
03-07424	- O	85311	89424	
03-07424PLUS	- O	85311	89424	
23-08233	OIO	85308	89422	
23-10393	OIO	85308	89422	
23-12262	OIO			85012	89413	
665133	OIO	83203	89436	

APPLICATION GUIDE - TRUCKS, TRAILERS, AND BUSES

Year Año Année	Model Modelo Modèle	OEM #	Front		Rear	
						
						
			Fleetline	GasSLX	Fleetline	GasSLX

PETERBILT(Cont'd.)





Additional Applications(Cont'd.)

	Models with O.E.M. Number	665617	010	85031
		665655	010	85062	89408	
		665656	010	85012	89413	
		665657	010	85013	89414	
		665658	010	85036	89405	
		665660		-10	85033	89427
		665662	010	85012	89413	
		665738	010	85910
		665752		010	85067	89451
		665762	010	85012	89413	
		665788		010	85000	89436
		665826		-1-	85069	89455
		665858	010	85070	89459	
		665876	010	85959
		665945		-1-	85902	...
		671091		-1-	85069	89455
		671092	010	85012	89413	
		671963		01-	85937	...
		680026		010	85302	89420
		680027		010	85308	89422
		680185		010	85308	89422
		680241		-10	85311	89424
		680348	010	85012	89413	
		680435		-10	85033	89427
		680457	010	85302	89420	
		680458		-1-	85336	...
		680459		-10	85311	89424
		680586		-10	85311	89424
		B71-1000	010	85031
		B71-1001	010	85070	89459	
		B71-1002	010	85001	89410	
		B71-1003	010	83312	89409	
	B71-6002	010	85012	89413		
	B71-6003	010	85029	
	B71-6004	010	85084	89460		
	B71-6008	010	83312	89409		
	C71-1013		01-	85985	...	
	C71-1014		01-	85936	89456	
	C71-6005		-1-	85069	89455	
2013 -	Models with O.E.M. Number	B71-6010	010	85023 or 89415				
	Models with Quadraflex 4 spring rear suspension	03-04628		-1-	85336	...

PETERBILT CAB SHOCKS

06 - 13	335 Day Cab models with O.E.M. Number	1202P055	010	83061	
- 14	337 Day Cab models with O.E.M. Number	1202P055	010	83061	
- 17	348 Day Cab models with O.E.M. Number	1202P055	010	83061	
	357, 375, 376, 377 & 378 Conventional Truck & Tractors with Link Cabmate Models PBC377 & PBC377-A	1202-0054	010	83021	
81 -	362 Cabovers with Link Cabmate Model PB-362-2P	1202-0032	010	83016	
78 -	48" Sleepers with Link Bunkmate Model PBS48-A	1202-1044	010	83025	
78 -	63" Sleepers with Link Bunkmate Model PBS63-A	1202-1044	010	83025	









APPLICATION GUIDE - TRUCKS, TRAILERS, AND BUSES

Year Año Année	Model Modelo Modèle	OEM #	Front		Rear	
						
			Fleetline	GasSLX	Fleetline	GasSLX

PETERBILT CAB SHOCKS(Cont'd.)

	Models with Link Cab Suspension	1202-0022	010	83046
	Models with O.E.M. Number	654782	010	83008
		654812	010	83042
		654919	010	83035
		R71-1004	010	83049
		R71-1005	010	83024
	Models with PowerPacker Cab Suspension	96027-1054	010	83011
		PP1058870	010	83059
		PP1059870	010	83060
		PP2582870	010	83012
359 Series				
	359 Conventional Truck & Tractors with Link Cabmate Models PBC379 & PBC379-A	1202-0054	010	83021
	359 Models (Older Models) Conventional Tractors with Link Cabmate Model PBCAL359	1201-0012	010	83023
		1202-0012	010	83023
365 Series				
08 - 17	365 Conventional Day Cab with O.E.M. Number	20-16755	010	83042
		R71-6005	010	83042
367 Series				
08 - 17	367 Conventional Day Cab with O.E.M. Number	20-16755	010	83042
		R71-6005	010	83042
08 - 16	367 Models with 70" Sleepers	29-02455	010	83008
		R71-6007	010	83008
377 & 379 Series				
	377 & 379 Conventional Models with Unibuilt Cab	29-02455	010	83008
		R71-6007	010	83008
	379 Conventional Truck & Tractors with Link Cabmate Models PBC379 & PBC379-A	1202-0054	010	83021
384 Series				
08 - 16	384 Conventional Day Cab with O.E.M. Number	20-16755	010	83042
		R71-6005	010	83042
386 Series				
06 - 16	386 Conventional Day Cab with O.E.M. Number	20-16755	010	83042
		R71-6005	010	83042
06 - 16	386 Models with Sleepers	29-02455	010	83008
		R71-6007	010	83008
387 Series				
99 -	387 Models with 70" Sleepers	29-06032	010	83035
		R71-6008	010	83035
99 -	387 Models with O.E.M. Number	29-06005	010	83035
08 - 11	DayCab Models with O.E.M. Number	R71-6000	010	83067
		R71-6010	010	83067
388 Series				
08 - 17	388 Conventional Day Cab with O.E.M. Number	20-16755	010	83042
		R71-6005	010	83042
08 - 16	388 Models with 70" Sleepers	29-02455	010	83008
		R71-6007	010	83008
389 Series				
- 16	389 Day Cab models with O.E.M. Number	20-19140	010	83063
		R71-6006	010	83063
08 - 16	389 Models with 70" Sleepers	29-02455	010	83008

APPLICATION GUIDE - TRUCKS, TRAILERS, AND BUSES

Year Año Année	Model Modelo Modèle	OEM #	Front		Rear	
						
						
			Fleetline	GasSLX	Fleetline	GasSLX

PETERBILT CAB SHOCKS(Cont'd.)

389 Series(Cont'd.)

08 - 16	389 Models with 70" Sleepers	R71-6007	OIO	83008
---------	------------------------------	----------	-----	--------------

587 Series

11 - 16	587 Models with 70" Sleepers	29-06032	OIO	83035
		R71-6008	OIO	83035

PIERCE MANUFACTURING INC.

Pierce FireTrucks with O.E.M. Number	680401	OIO	85307
Additional O.E.M. Interchanges	1445910	OIO	85300 or 89419			
	40-0242	OIO	83312 or 89409			
	40-4845	OIO	85304			
	40-4951	-IO	85316 or 89426			
	40-5348	OIO	85058 or 89431			
	40-6967	OIO	85030 or 89440			

POWERPACKER CAB SHOCKS

Models with PowerPacker Cab Suspension	PP1058870	OIO	83059	
	PP1059870	OIO	83060	

PREVOST

04 - 09	H3 Bus, H3 VIP Bus Drive and Tag Axle Shocks	630253					
		481700999386	OIO	85713	...		
		630127	OIO	85736	...		
		650407	OIO	85736	...		
		VIP with Independant Front Suspension	48170000208	OIO	85379	...	
			630251	OIO	85379	...	
		With I-Beam Front Suspension	630252	OIO	85329	...	
			481700999376	OIO	85329	...	
			630134	OIO	85329	...	
			680422	OIO	85329	...	
	Intercity Bus with O.E.M. Number	481700999427	OIO	85380	...		
		630228	OIO	85380	...		
		680583	OIO	85380	...		
	LeMirage XL 40 ft, 45 ft, & H Models Coaches with Independant Front Suspension	630136	OIO	85330	...		
	LeMirage XL 40 ft, 45 ft, & H3-45 VIP Coaches with I-Beam Front Suspension	481700999376	OIO	85329	...		
		630134	OIO	85329	...		
	Low Floor Bus Models with O.E.M. Number	N16249	OIO	85378	...		
	X3-45 Bus						
	Drive and Tag Axle Shocks	630253	OIO	85713	...		
	With I-Beam Front Suspension	48170000206	OIO	85380	...		
		630254	OIO	85380	...		
	With Independant Front Suspension	630136	OIO	85330	...		
04 - 06	XL II Bus, XL II MTH Bus Drive and Tag Axle Shocks	630253					
		481700999386	OIO	85713	...		
		630127	OIO	85736	...		
		650407	OIO	85736	...		
		With I-Beam Front Suspension	630252	OIO	85329	...	
			481700999376	OIO	85329	...	
		630134	OIO	85329	...		





APPLICATION GUIDE - TRUCKS, TRAILERS, AND BUSES

Year Año Année	Model Modelo Modèle	OEM #	Front		Rear	
			Fleetline	GasSLX	Fleetline	GasSLX

PREVOST(Cont'd.)

99 - 03	With I-Beam Front Suspension With Independent Front Suspension	680422 481700000208 630251 481700999377 630163	010	85329	
			01-	85379	
			01-	85379	
			01-	85330	
			01-	85330	
07 - 09	XL II MTH Bus Drive and Tag Axle Shocks Front Suspension	630253 630136		010	85713	...	
			01-	85330	
89 - 00	XL-45 Coach Drive and Tag Axle Shocks With I-Beam Front Suspension	481700999386 630127 650407 481700999376 630134 680422		010	85736	...	
				010	85736	...	
				010	85736	...	
			010	85329	
			010	85329	
			010	85329	
	Models with O.E.M. Number	12L-5-89 12T-1-13 19501288 19501289 19501547 481700000207 481700000209 630103 630161 630234 630235 630236 680510 G5008070		01-	85729	...	
				85303	...	010	85303	89422	
				01-	85729	...	
			1-	85728	
				01-	85740	...	
			010	85329	
				010	85713	...	
			010	85329	
				010	85736	...	
			010	85329	
			01-	85330	
			010	85329	
			01-	85330	
			010	85700	
				Additional O.E.M. Interchanges	01-0100-905 0822045526 12B-5-1 19501669 19502711 19506846 196347 196533 3166657 481700999377 52001 630001 630080 630091 630163 63-1013 680323 680492 680555 690060 74939852 G1011822 N22212	010	85303 or 89422		
010	85702								
010	85735								
010	85339								
010	85702								
010	85339								
10-	85710								
1-	85708								
010	85700								
01-	85330								
1-	85708								
010	85713								
010	85713								
010	85736								
01-	85330								
010	85329								
010	85700								
010	85713								
01-	85330								
010	85713								
010	85308 or 89422								
010	85702								
010	85700								

APPLICATION GUIDE - TRUCKS, TRAILERS, AND BUSES

Year Año Année	Model Modelo Modèle	OEM #	Front		Rear	
						
			Fleetline	GasSLX	Fleetline	GasSLX

REYCO SUSPENSION(Cont'd.)

Trailer(Cont'd.)

19AR / RS1062 Models with O.E.M. Number	700098-03	010	85052	...
20 AR / RS 3162 Models with O.E.M. number	18163-01	010	83207	89407
21B (Special) Models	18800-01	010	83203	89436
23 ART Models with O.E.M. Number	23523-01	010	85086	...
	665748	010	85086	...
25 ART Models with O.E.M. Number	24392-01	010	85051	...
25 ARU Models with O.E.M. Number	23553-01	010	85938	...
30 ART with O.E.M. Number	23524-01	010	85738	...
30 ARUU - 14 and -15 Models	23553-01	010	85938	...
30 ARUU - 9, -12 and -17 Models	23524-01	010	85738	...
30 ARUUL - 12 and -17 Models	23524-01	010	85738	...
30 ARUUL - 9, -14 and -15 Models	23553-01	010	85938	...
81C Models	12885-03	010	85300	89419
81LC Models	12885-01	010	85300	89419
81LM Models	12886-01	010	85334	...
81S Models	12885-03	010	85300	89419
86 AR / RS 1015, 1035, 3035 Slider Air Suspension	18165-01	010	85006	...
87 for Great Dane Models	18163-01	010	83207	89407
	18164-01	010	83122	89406
87-14 (Rear Mount) Models	18146-01	010	85313	...
87-14, -17 Models	16230-01	010	85702	...
87-14, -17 Slider Models	12885-01	010	85300	89419
87-6, 87-9 Models	12885-01	010	85300	89419
87M-12 Models	18146-01	010	85313	...

Additional Applications





Models with O.E.M. Number	16824-01	010	85006	...
	17142-01	010	85001	89410
	20960-01	010	83204	...
	23106-01	010	85975	...
	23614-01	010	85717	...
	665519	010	...	89414
	665813	010	85051	...
	665830	010	85045	...
	665833	010	85052	...
	671707	010	85052	...
	680551	010	85738	...
	680552	010	85938	...
	680700	010	85938	...
	700098-01	010	83128	89436
	702135-01	010	85045	...
	702136-01	010	85052	...
	702209-01	010	85014	...
	704672-01	010	85938	...

RIDEWELL CORPORATION

Bus and R.V. Air-Rides

Mobile Home & RV with Air Suspension	AS563B	010	83203	89436
	S6009B	010	83203	89436
RAS - 227 Models Steer Axles Air Suspension w/ O.E.M. Number	1260008	010	87017	...
	90-2610 SP1	010	87017	...

APPLICATION GUIDE - TRUCKS, TRAILERS, AND BUSES

Year Año Année	Model Modelo Modèle	OEM #	Front		Rear	
						
			Fleetline	GasSLX	Fleetline	GasSLX

RIDEWELL CORPORATION(Cont'd.)





Trailer Air-Rides(Cont'd.)

RAR - 244 FeatherRide Light Duty Air Suspension (8,000 lb Capacity)	1270007		010	85045	...
RAR-210							
With Double Convolution Spring	AS789B		010	85014	...
	S5878B		010	83207	89407
With Shock Absorber Bracket 2-1/2" Above Frame Rail	010	85006	...
With Shock Absorber Bracket 2-7/8" Above Lower Frame Rail	010	83207	89407
With Shock Absorber Bracket 3" Above Lower Frame Rail	010	85005	89430
With Shock Absorber Bracket Even With Underside of Frame	AS546B		010	85006	...
RAR-210 For Trailers with 25" Drop	1253069B000		010	85005	89430
	AS30698		010	85005	89430
	AS3069B		010	85005	89430
RAR-210 Tag Axle	AS563B		010	83203	89436
	S6009B		010	83203	89436
RAR-221 Tag Axle	AS563B		010	83203	89436
	AS789B		010	85014	...
	S5878B		010	83207	89407
	S6009B		010	83203	89436
RAR-221-11, 12, 13-USW Trailer with Shock Absorber and Hanger	AS563B		010	83203	89436
	S6009B		010	83203	89436
RAR-221AS-11-USW, RAR-221AS-11-1-USW Trailer	1253069B000		010	85005	89430
	AS30698		010	85005	89430
	AS3069B		010	85005	89430
RAR-221AS-12-USW, RAR-221AS-12-1-USW Trailer	1250546B000		010	85006	...
	AS546B		010	85006	...
RAR-240, RAR-240W (Mono Pivot Trailers with HD Air Suspension)							
With O.E.M. Number	1270563B000		010	85000	89436
	1270563B003		010	85934	...
	1270789B000		010	85014	...
RAR-243 (Mono Pivot Trailers with HD Air Suspension)	1270563B003		010	85934	...
RAR-260 Overslung Air Suspension (25,000 lb Capacity)	1270563B003		010	85934	...
RAR-260 Underslung Air Suspension (25,000 lb and 30,000 lb Capacity)	1270563B003		010	85934	...
RideLite Trailer Air Suspension	1270563B003		010	85934	...
Models with O.E.M. Number	1275943B		010	85005	89430
	57645		010	85005	89430
	665526		010	85014	...

Truck Air-Rides

Fire Truck with Ridewell Front Suspension	AS 4025B	010	85712
Pusher w/Axle Lift	AS563B		010	83203	89436
	S6009B		010	83203	89436
RAD-221R Drive Axle	S2607B		010	85702	...
	S5477B		010	85307	...
RCA-215 Models Air Suspension (RCA-215 LM, RCA-215 MM)	1250789B000		010	85014	...
RD-202B Tandem Drive Axle	S5478B		010	85307	...
RD-202S-54-48-BS Tandem Drive Air Suspension	1252607B000		010	85702	...
RD-202S-54-52T-SR Tandem Drive Air Suspension	1252607B000		010	85702	...
RSS-236, RSS-236R Self Steering Tag/Pusher Lift Axle (For 13000 lb & 16000 lb Capacity)	1253069B000		010	85005	89430

APPLICATION GUIDE - TRUCKS, TRAILERS, AND BUSES

Year Año Année	Model Modelo Modèle	OEM #	Front		Rear	
						
			Fleetline	GasSLX	Fleetline	GasSLX

RIDEWELL CORPORATION(Cont'd.)

Truck Air-Rides(Cont'd.)

	RSS-236, RSS-236R Self Steering Tag/Pusher Lift Axle (For 13000 lb & 16000 lb Capacity)	AS30698	010	85005	89430
		AS3069B	010	85005	89430
	RUA-220B-1-, 10, 10.5, 11, 11.5, 12, 12.5, 13 (Lift Tag Axle & Trailer Lift Suspension)	1250789B000	010	85014	...
		AS789B000	010	85014	...
	RUA-220B-1-, 7, 7.5, 8, 8.5, 9, 9.5, 10 (Lift Tag Axle & Trailer Lift Suspension)	1270563B000	010	85000	89436
	Models with O.E.M. Number	1250563B000	010	85000	89436
		1252607B000	010	85702	...
		1253069B000	010	85005	89430
		1254190B000	010	85302	89420
		12651527B000	010	85712	...
		1266009B000	010	83130	...
		1267120B000	010	85734	...
		1267395B000	010	85302	89420
		1275813B000	010	85704	...
		665198	010	85005	89430
		665267	010	85029	...
		680101	010	85702	...
		70654	010	85000	89436
		AS575B	010	85005	89430
		S4025B	010	85712	...
		S5813B	010	85704	...
		S7120B	010	85304	...
S7172B	010	83207	89407		
S7249B	010	85307	...		
S7365B	010	85305	...		
	Additional O.E.M. Interchanges	1250005	010	85901			
		1254025B000	010	85712			
		1265478B000	010	85736			
		1267249B000	010	85712			

ROADMASTER (MONACO)





	Models with AD-123 Models Suspension (AD123-6,-8,-10,-8.75)	90045132	010	85909	...
	Models with O.E.M. Number	90045188	010	85910	...

SAF HOLLAND

Trailer Air Suspension

	AirLite 2 Model Trailer Air Suspension	90044025	010	83209	89414
	AR-120 Models Trailer Air Suspension (AR-120, AR-120-L, AR-120-US, AR-120-US-F) (AR-120-US-L, -1, -2, -3)	90044626	010	83126	89430
		90044625	010	83125	...
	AR-125 Models Trailer Air Suspension (AR-125, AR-125-L, AR-125-US, AR-125-US-F) (AR-125-US-L, -1, -2, -3)	90044626	010	83126	89430
		90044625	010	83125	...
	AR-165-US Models Trailer Air Suspension (AR165-US)	90044626	010	83126	89430
	AR-250 Models Trailer Air Suspension (AR-250-12) (AR-250-14, -15) (AR-250-16, -17)	90045054	010	85051	...
		90044642	010	83127	...
		90044089	010	83124	89407

APPLICATION GUIDE - TRUCKS, TRAILERS, AND BUSES





Year Año Année	Model Modelo Modèle	OEM #	Front		Rear	
						
			Fleetline	GasSLX	Fleetline	GasSLX

SAF HOLLAND(Cont'd.)

Trailer Air Suspension(Cont'd.)

AR-41 Models Trailer Air Suspension (All)	90044162	010	83128	89436
AR-45 Models Trailer Air Suspension (AR-45, AR-45-1)	90044162	010	83128	89436
AR-50 Models Trailer Air Suspension (AR-50-US, AR-50-US-F,-1,-2)	90044162	010	83128	89436
AR-51 Models Trailer Air Suspension (AR51-US)	90044162	010	83128	89436
AR-70 Models Trailer Air Suspension (AR-70-9, -14, AR-70A-9, 14)	90044626	010	83126	89430
AR-75 Models Trailer Air Suspension (AR-75-12)	90044625	010	83125	...
(AR-75-6, -9, -1-12)	90044626	010	83126	89430
AR-80 Models Trailer Air Suspension (AR-80-6.75)	90044046	010	83123	89405
(AR-80-9, -9FM)	90044868	010	85045	...
(AR-80-9-WST)	90044626	010	83126	89430
AR-85-A Models Trailer Air Suspension (AR-85-A)	90044625	010	83125	...
AR-90 Models Trailer Air Suspension (AR-90-14, -15, -16, -17)	90044089	010	83124	89407
AR-90-1 Models Trailer Air Suspension (AR-90-1-12, -14, -17)	90044162	010	83128	89436
(AR-90-1-15, -16)	90044448	010	85051	...
	90045054	010	85051	...
AR-92 Models Trailer Air Suspension (AR-92-12)	90044162	010	83128	89436
	90044992	010	85000	89436
(AR-92-14)	90045040	010	83130	...
(AR-92-15)	90044448	010	85051	...
	90045054	010	85051	...
(AR-92-16)	90044794	010	83127	...
(AR-92-17)	90044642	010	83127	...
(AR-92-18)	90044089	010	83124	89407
	90044769	010	83207	89407
AR-93 Models Trailer Air Suspension (AR-93-14)	90044448	010	85051	...
	90045054	010	85051	...
(AR-93-15)	90044794	010	83127	...
(AR-93-16)	90044642	010	83127	...
(AR-93-17)	90044089	010	83124	89407
	90044769	010	83207	89407
AR-94 Models Trailer Air Suspension	90045028	010	85907	...
	90045048	010	85905	...
	90045049	010	85905	...
AR-95 Models Trailer Air Suspension (AR-95-9, -12, -14, -17, All -HD Models, AR-95A-9, -12, -14, -17)	90044625	010	83125	...
AR-955 Models Trailer Air Suspension (Liftaxle) (AR-955-9, -12, -14, -17)	90044625	010	83125	...
(AR-955-9HD, -12HD, -14HD, -17HD)	90044625	010	83125	...
(AR-955A-9, -12, -14, -17)	90044625	010	83125	...

APPLICATION GUIDE - TRUCKS, TRAILERS, AND BUSES





Year Año Année	Model Modelo Modèle	OEM #	Front		Rear	
						
			Fleetline	GasSLX	Fleetline	GasSLX

SAF HOLLAND(Cont'd.)

Trailer Air Suspension(Cont'd.)

(AR-955A-9HD, -12HD, -14HD, -17HD)	90044625	010	83125	...
ARA-93 Models Trailer Air Suspension (ARA-93-14)	90045054	010	85051	...
ARL20 Models Trailer Air Suspension (ARL20-D, ARL20-D-US)	90044162	010	83128	89436
ARS112 Models Trailer Air Suspension (ARS112-6)	90045096	010	85916	...
ARU-92 Models Trailer Air Suspension (ARU-92-8, -9, -10, -12)	90044642	010	83127	...
ARU-93 Models Trailer Air Suspension (ARU-93-6)	90045040	010	83130	...
(ARU-93-7, -8, -9, -10)	90044642	010	83127	...
ARU-98 Models Trailer Air Suspension (ARU-98-17)	90045054	010	85051	...
CB-2300 Models Trailer Air Suspension (CB-2300-14)	90044868	010	85045	...
(CB-2300-15)	90045381	010	83150	...
(CB-2300-16, CB-2300-17)	90045298	010	83128	...
CB-400/4000 Models Trailer Air Suspension (CB-400-15.5, CB-400-16.0)	90045298	010	83128	...
(CB-400-16.5, CB-400-17.0)	90044162	010	83128	89436
(CB-400-18.0)	90045040	010	83130	...
CBX 23 Models Trailer Air Suspension (CBX 23-14)	90044868	010	85045	...
(CBX 23-15)	90045381	010	83150	...
(CBX 23-16, CBX 23-17)	90045298	010	83128	...
CBX 23 with 245 or 317 Fusion Axle and Beam Assembly For Bracket Type #1, 3, 4, & 5 - 16.0" & 17.0" Ride Height	90045299	010	83389	89436
CBX 25 Models Trailer Air Suspension (CBX 25-14)	90045607	010	83150	...
(CBX 25-16, CBX 25-17)	90045040	010	83130	...
CBX 25 with 245 Fusion Axle and Beam Assembly (16.0" & 17.0" Ride Height)	90045299	010	83389	89436
CBX 30 with 245 Fusion Axle and Beam Assembly (16.0" & 17.0" Ride Height)	90045299	010	83389	89436
CBX 40 Models Trailer Air Suspension (CBX 40 -16.5, CBX 40 -17.0)	90044162	010	83128	89436
(CBX 40-15.5, CBX 40-16.0)	90045298	010	83128	...
(CBX 40-18.0)	90045040	010	83130	...
CBX 46 Models Trailer Air Suspension (16.5" & 17.0" Ride Height)	90044162	010	83128	89436
CBX 50 Models Trailer Air Suspension (16.5" & 17.0" Ride Height)	90044162	010	83128	89436
NL-200 Models Non Steer - Auxiliary Lift Air Suspension (NL-200-1S, NL-200-2S)	90044162	010	83128	89436
NS-190 Models Trailer Air Suspension (NS-190-16.0)	90044162	010	83128	89436
(NS-190-16.5, NS-190-17.0)	90045040	010	83130	...
(NS-190-18.0)	90045054	010	85051	...
NS-400 Models Trailer Air Suspension (NS-400-16.0)	90045298	010	83128	...
(NS-400-16.5)	90044162	010	83128	89436
(NS-400-18.0)	90045040	010	83130	...
NS-400 Models Trailer Air Suspension (17.0" Ride Height)	90045299	010	83389	89436

APPLICATION GUIDE - TRUCKS, TRAILERS, AND BUSES





Year Año Année	Model Modelo Modèle	OEM #	Front		Rear	
						
			Fleetline	GasSLX	Fleetline	GasSLX

SAF HOLLAND(Cont'd.)

Trailer Air Suspension(Cont'd.)

NS-450 Models Trailer Air Suspension (NS-450-16.0) (NS-450-16.5) (NS-450-18.0)	90045298		010	83128	...
	90044162		010	83128	89436
	90045040		010	83130	...
NS-450 Models Trailer Air Suspension (17.0" Ride Height)	90045299		010	83389	89436
RL-196 Models Trailer Air Suspension (RL-196-12) (RL-196-14, -15) (RL-196-16, -17)	90044977		010	83115	...
	90044978		010	85059	...
	90044979		010	83113	...
RL-196A Models Trailer Air Suspension (RL-196A-12) (RL-196A-14, -15) (RL-196A-16, -17)	90044162		010	83128	89436
	90045040		010	83130	...
	90044794		010	83127	...
RL-228 Models Trailer Air Suspension (RL-228-12-3) (RL-228-14-3, -14-4, -15-3, -16-3) (RL-228-17-3)	90044162		010	83128	89436
	90044642		010	83127	...
	90044089		010	83124	89407
RL-230 Models Trailer Air Suspension (RL-230-12-3) (RL-230-14-3, -15-3) (RL-230-16-3, -17-3)	90045381		010	83150	...
	90044642		010	83127	...
	90044089		010	83124	89407
RL-230 Models Trailer Air Suspension (Hanger Mounted Shock) (RL-230-14-3, -15-4) (RL-230-16-4) (RL-230-17-4)	90045381		010	83150	...
	90045299		010	83389	89436
	90045040		010	83130	...
RL-230 Models Trailer Air Suspension (Single Stud Air Spring) (RL-230-14-3, -15-4, -16-4) (RL-230-17-4)	90044642		010	83127	...
	90044089		010	83124	89407
RL-250 Models Trailer Air Suspension (Shock Below Frame) (RL-250-14-3, -15-4) (RL-250-16-4, -17-4)	90045040		010	83130	...
	90045299		010	83389	89436
RL-250 Models Trailer Air Suspension (Std Suspension) (RL-250-12) (RL-250-14.0, -15.0) (RL-250-16.0, -17.0)	90045054		010	85051	...
	90044642		010	83127	...
	90044089		010	83124	89407
RL-300 Models Trailer Air Suspension (Offset Stud Air Spring) (RL-300-13) (RL-300-14, -15, -16, -17)	90045054		010	85051	...
	90045338		010	85060	...
RL-300 Models Trailer Air Suspension (Std Suspension) (RL-300-12, -13) (RL-300-14, -15, -16, -17)	90045054		010	85051	...
	90045338		010	85060	...
RLSA Models Trailer Air Suspension (RLSA-4212, -4812)	90044977		010	83115	...
RLSA Models Trailer Air Suspension (RLSA-4214, -4215, -4814, -4815)	90044978		010	85059	...
RLSA Models Trailer Air Suspension (RLSA-4216, -4217, -4816, -4817)	90044979		010	83113	...
RLSA228 Models Trailer Air Suspension (RLSA-228-4214, -4215, -4216, -4814, -4815, -4816)	90044642		010	83127	...
RLSA228 Models Trailer Air Suspension (RLSA-228-4217, -4817)	90044089		010	83124	89407
RLU-228 Models Trailer Air Suspension (RLU-228-10-3)	90044089		010	83124	89407

APPLICATION GUIDE - TRUCKS, TRAILERS, AND BUSES





Year Año Année	Model Modelo Modèle	OEM #	Front		Rear	
						
			Fleetline	GasSLX	Fleetline	GasSLX

SAF HOLLAND(Cont'd.)

Trailer Air Suspension(Cont'd.)

	(RLU-228-6-3)	90045040	010	83130	...
	(RLU-228-7-3)	90044642	010	83127	...
	(RLU-228-8-3, RLU-228-9-3)	90044626	010	83126	89430
	RLU-228 Models Trailer Air Suspension (Axle Mounted Shock Suspension)						
	(RLU-228-8-3)	90044162	010	83128	89436
	(RLU-228-9-3, RLU-228-10-3, RLU-228-12-3)	90044642	010	83127	...
	RLU-228 Models Trailer Air Suspension (Current Production - w/3" Axle Travel Up)						
	(RLU-228-10-3, RLU-228-12-3)	90044642	010	83127	...
	(RLU-228-6-3)	90045298	010	83128	...
	(RLU-228-7-3)	90044162	010	83128	89436
	(RLU-228-8-3)	90045040	010	83130	...
	(RLU-228-9-3)	90045054	010	85051	...
	RLU-228 Models Trailer Air Suspension (Current Production - w/4" Axle Travel Up)						
	(RLU-228-10-4)	90044642	010	83127	...
	(RLU-228-8-4)	90044162	010	83128	89436
	(RLU-228-9-4, RLU-228-12-4)	90044626	010	83126	89430
	RLU-228 Models Trailer Air Suspension (Current Production - w/4" Axle Travel Up) HVY DTY						
	(RLU-228-8-4)	90045337	010	85911	...
	RLU-250 Models Trailer Air Suspension						
	(RLU-250-12)	90044642	010	83127	...
	(RLU-250-6.5)	90045381	010	83150	...
	(RLU-250-9)	90044162	010	83128	89436
	RLU-250 Models Trailer Air Suspension (Frame Mount Suspension)						
	(RLU-250-12-FMT)	90045054	010	85051	...
	(RLU-250-6.5-FMT)	90045381	010	83150	...
	(RLU-250-9-FMT)	90044162	010	83128	89436
	RLU-300 Models Trailer Air Suspension (Std Suspension)						
	(RLU-300-6.5)	90045471	010	83150	...
	(RLU-300-9)	90045337	010	85911	...
	Trailer Air Suspension (RL196-16,-17)	90044979	010	83113	...
	CBX 69 Trailer Air Suspension	90045669	010	83389	89436
	Models with O.E.M. Number						
		665454	010	85045	...
		671931	010	85916	...
		680234	010	85906	89407
		680268	010	85323	89436
		90044980	010	85907	...
		90045000	010	85906	89407
		90045001	010	85323	89436
		90045002	010	85906	89407
		90045003	010	85323	89436
		90045019	010	85913	...
		90045080	010	85912	...
		90045083	010	85910	...
		90045188	010	85910	...
		90045207	010	...	89405
		90045433	010	85916	...
		90045563	010	85014	...
		90045564	010	83128	89436

APPLICATION GUIDE - TRUCKS, TRAILERS, AND BUSES

Year Año Année	Model Modelo Modèle	OEM #	Front		Rear	
						
			Fleetline	GasSLX	Fleetline	GasSLX

SAF HOLLAND(Cont'd.)









Trailer Air Suspension(Cont'd.)

Models with O.E.M. Number	90045572	010	85045	...
	90045574	010	83130	...
	90045575	010	85051	...
	90045576	010	83150	...
	90045665	010	85029	...
	90045667	010	85060	...
	XB-SPN-053-36	010	83125	...
Models with O.E.M. Number (Hvy Duty)	90045666	010	85051	...
Models with O.E.M. Number (STD)	90045666	010	83130	...

Truck & Tractor Air Suspension (Tag Axle)

Models with O.E.M. Number	57639	010	85000	89436
	57643	010	85013	89414
	6025	010	83122	89406
	6026	010	83204	...
	665197	010	85051	...
	665514	010	83127	...
	665969	010	...	89430
	90044001	010	85005	89430
	90044071	010	85000	89436
	90044081	010	85000	89436
	90044086	010	85000	89436
	90044089C	010	83124	89407
	90044095	010	83203	89436
	90044679	010	83122	89406
	90044680	010	83125	...
	90044681	010	83204	...
	90044682	010	83209	89414
	90044683	010	83122	89406
	90044684	010	83124	89407
	90044685	010	83389	89439
	90044686	010	85051	...
	90044687	010	83125	...
	90044688	010	83122	89406
	90044770	010	83207	89407
	90044833	010	85052	...
	90044834	010	85052	...
	90044878	01-	83635	...
	90044915	010	83127	...
	90044981	010	85000	89436
	90044982	010	85000	89436
	90044991	010	85000	89436
	90045110	010	83137	...
	90045175	010	85916	...
	90045384	010	...	89430
	AR-1008	010	85006	...
	AR-1141	010	83204	...
	AR-1141-C	010	83204	...
	AR-1202	010	85300	89419
	AR-134-C	010	85005	89430
	AR-1404	010	85301	...
	AR-1425	010	85301	...

APPLICATION GUIDE - TRUCKS, TRAILERS, AND BUSES

Year Año Année	Model Modelo Modèle	OEM #	Front		Rear	
						
						
			Fleetline	GasSLX	Fleetline	GasSLX

SAF HOLLAND(Cont'd.)

Truck & Tractor Air Suspension (Tag Axle)(Cont'd.)

Models with O.E.M. Number	AR-1434	010	83203	89436
	AR-1654	010	83209	89414
	AR-1822	010	85304	...
	AR-2451	010	83203	89436
	AR-2598	010	83123	89405
	AR-718-C	010	83203	89436
	AR-718-C-HD	010	85000	89436
	AR-781	010	83203	89436
	AR-958	010	83207	89407
	AR-995	010	85734	...

Truck, Bus & Motorhome Air Suspensions

AD-123 Models Truck and Tractor Air Suspension (AD123-6,-8,-10,-8.75)	90045068	-10	...	89441
AD-123 Models Truck and Tractor Air Suspension (AD123-6,-8,-10,-8.75) Shock Mount approx. 2-1/2" above bottom of frame Shock Mount flush with bottom of frame	90045132	010	85909	...
	90045099	010	85906	89407
AD-130 Models Truck and Tractor Air Suspension (AD123-6,-8,-10,-8.75)	90045466	010	...	89406
AD-130 Models Truck and Tractor Air Suspension W/ OEM Number	90045432	010	85321	...
AD-150 Models Truck & Tractor Air Suspension	90045075	010	85911	...
AD-200 Models Truck & Tractor Air Suspension (AD-200-7, -8, -9, -11)	90045138	010	85910	...
AD-246 Models Truck & Tractor Air Suspension (AD246 -6, -8, -10, -8.75)	90045099	010	85906	89407
	90045132	010	85909	...
00 - AD-246 Models with 10" Ride Height	90045504	010	85030	...
AD-252-10 Tandem Axle	90045132	010	85909	...
00 - AD-369 Models with 10" Ride Height	90045504	010	85030	...
ADZ-123 Models Truck and Bus Air Suspension	90045605	010	85109	...
ADZ-126 Models Truck and Bus Air Suspension	90045605	010	85109	...
ADZ-246 Models Truck and Bus Air Suspension	90045605	010	85109	...
ADZ-252 Models Truck and Bus Air Suspension	90045605	010	85109	...
ADZ-369 Models Truck and Bus Air Suspension	90045605	010	85109	...
ADZ-378 Models Truck and Bus Air Suspension	90045605	010	85109	...
ARD-120 Models Truck & Tractor Air Suspension (ARD-120-6)	90044025	010	83209	89414
				
ARD-125 Models Truck & Tractor Air Suspension (ARD-125-6 use on Ford, GM, International (Navistar), Mack, White, Western Star, Freightliner) (ARD-125-8 use on Freightliner, White, Western Star) (ARD-125-8 use on Mack)	90044025	010	83209	89414
	90044011	010	85004	...
	90044016	010	85300	89419
ARD-165 Models Truck & Tractor Air Suspension (ARD-165-A, ARD-165-B)	90044011	010	85004	...
ARD-190 Models Truck & Tractor Air Suspension (ARD-190-B)	90044016	010	85300	89419
ARD-234 Models Truck & Tractor Air Suspension (ARD-234-6)	90044046	010	83123	89405
ARD-238 Models Truck & Tractor Air Suspension (ARD-238-6)	90044025	010	83209	89414
ARD-238-6 Models Truck & Tractor Air Suspension	90044025	010	83209	89414
ARD-244 Models Truck & Tractor Air Suspension (ARD-244-6 use on Ford, GM, International (Navistar), Mack, White, Western Star, Freightliner) (ARD-244-8 use on Freightliner, White, Western Star) (ARD-244-8 use on Mack)	90044025	010	83209	89414
	90044011	010	85004	...
	90044016	010	85300	89419

APPLICATION GUIDE - TRUCKS, TRAILERS, AND BUSES









Year Año Année	Model Modelo Modèle	OEM #	Front		Rear	
			Fleetline	GasSLX	Fleetline	GasSLX

SAF HOLLAND(Cont'd.)

Truck, Bus & Motorhome Air Suspensions(Cont'd.)

ARDAB-120 Models Truck & Tractor Air Suspension (ARDAB-120-5)	90044907		01-	83635	...
ARDAB-238-5 Models Truck & Tractor Air Suspension	90044907		01-	83635	...
ARDAB-240 Models Truck & Tractor Air Suspension (ARDAB-240-5)	90044907		01-	83635	...
ARDST-123 Models Truck & Tractor Air Suspension (ARDST-123-6, ARDSTM/L-123-6)	90044025		010	83209	89414
ARDST-244 Models Truck & Tractor Air Suspension (ARDST-244-6)	90044025		010	83209	89414
ARDST-246 Models Truck & Tractor Air Suspension (ARDST-246-6, ARDSTM/L-246-6)	90044025		010	83209	89414
ARDST-250-6 Models Truck & Tractor Air Suspension	90044025		010	83209	89414
ARDTB-125 Models Bus Air Suspension (ARDTB-125-6A)	90044448		010	85051	...
ARDTB-125 Models Bus Air Suspension (ARDTB-125-6B)	90045031		010	85968	...
ARDTB-125-6A (Note: Front shock)	90045050	010	85914
ARDTB-125-6A (Note: Rear shock)	90045053		010	85908	...
ART-500 Models Truck & Tractor Tag Axle Air Suspension (ART-500-B, ART-500-B-1) (ART-500-US, ART-500-US-A)	90044162 90044008		010	83128	89436
ART-505 Models Truck & Tractor Tag Axle Air Suspension (ART-505-B, -1, ART-505-C, -1)	90044162		010	83128	89436
ART-541 Models Truck & Tractor Tag Axle Air Suspension (ART-541B)	90044162		010	83128	89436
ART-550 Models Truck & Tractor Tag Axle Air Suspension (ART-550-US-1, -2, -3)	90044012		010	85006	...
ART-551 Models Truck & Tractor Tag Axle Air Suspension (ART-551-B-1) (ART-551-B-2, -3, ART-551-US-1, -2, -3)	90044162 90044017		010	83128	89436
ART-555 Models Truck & Tractor Tag Axle Air Suspension (ART-555-B-1, ART-555-C-1) (ART-555-B-2, -3, ART555C-2, -3)	90044162 90044642		010	83128	89436
Models with O.E.M. Number	471700000433		010	85099	...
	471700000436		010	85030	...
	471700000458		010	85014	...
	471700000459		010	85030	...
	471700000460		010	85097	...
	471700000461		010	...	89414
	481700000483		010	85975	...
	481700000484		010	85974	...
	481700000485		010	85975	...
	665002		010	85004	...
	665003		010	85300	89419
	671921		010	85916	...
	671922		010	...	89405
	671923		010	...	89440
	680645		010	85321	...
	90045084		010	85968	...
	90045277		010	85030	...
	90045336		010	85014	...
	90045418		010	85916	...
	90045419		010	...	89405
	90045420		010	...	89440
	90045455		010	85909	...

APPLICATION GUIDE - TRUCKS, TRAILERS, AND BUSES

Year Año Année	Model Modelo Modèle	OEM #	Front		Rear	
						
						
			Fleetline	GasSLX	Fleetline	GasSLX

SAF HOLLAND(Cont'd.)

Truck, Bus & Motorhome Air Suspensions(Cont'd.)

	Models with O.E.M. Number	90045499		010	85974	...
		90045500		010	85975	...
		90045503		010	85975	...
		90045504		010	85030	...
		90045532		010	85030	...
		90045533		010	85099	...
		90045534		010	85014	...
		90045535		010	85097	...
		90045536		010	...	89414
		90045568		010	85060	...

SEAGRAVE FIRE APPARATUS LLC

	Models with O.E.M. Number	680117		010	85300	89419
		P0025500		010	85300	89419

SICARD

	Models with O.E.M. Number	3166657		85700	...	010	85700	...
--	---------------------------	---------	--	-------	-----	-----	-------	-----

SOUTHERN COACH

	Early Model Air Suspension		85304	...	010	85304	...
	Late Model Air Suspension		83217	...	010	83217	...
	U.S. Army Coaches		83217	...	010	83217	...

SPARTAN MOTORS

97 - 00	Alpine / Summit MotorHome Chassis with O.E.M. Number	0377-SS5		010	85029	...
		B46-1725		010	85029	...
	Buses with Hendrickson Softek Suspension with Drum and Disc Brakes	471700000456	010	85959
		58913-009	010	85959
	Chassis With Hendrickson HTS 210 Suspension (Type C School Bus Applications)	60665-025		010	85036	...
	Fire Truck with O.E.M. Number	0272-SS5	010	85712
86	Fire Truck with Ridewell Front Suspension	AS 4025B	010	85712
97 - 00	K2 / K3/ MountainMaster with O.E.M. Number	B46-2151		010	85007	89412
91 - 95	K2 / K3/ MountainMaster with Tuthill 102 AR Air Suspension	0346-SS5		010	85013	89414
		B46-1594		010	85013	89414
	Models with Reyco 1200 Steer Option)	21310-01	010	85307
	Motorhome chassis with Ridewell Front Suspension	AS 4025B	010	85712
	Models with O.E.M. Number	59011	010	83214
	Additional O.E.M. Interchanges	78068	010	85304				

STERLING TRUCK

A - Line 9500 Series (SilverStar)

98 -	A9513, A9522, AT9513, AT9522 (113" & 122" BBC) Models with 8500 or 9000 lb Axle and 54" Taperleaf Spring	F6HT-18045-HB	010	85054	89438	
		F6HT-18045-HC	010	85054	89438	
98 -	A9513, A9522, AT9513, AT9522 (113" & 122" BBC) Models with 8500, 9000 or 10000 lb Axle and 54" Multileaf Spring	F6HT-18045-KA	010	83200	89402	
98 -	All Models with 10000 lb or 12000 lb Axle and 54" Taperleaf Spring	F6HT-18045-AC	010	85054	89438	
98 -	All Models with 12000 lb or 13200 lb Axle and 54" Multileaf Spring	F6HT-18045-BC	010	85047	89435	

APPLICATION GUIDE - TRUCKS, TRAILERS, AND BUSES

Year Año Année	Model Modelo Modèle	OEM #	Front		Rear	
			Fleetline	GasSLX	Fleetline	GasSLX

STERLING TRUCK(Cont'd.)

A - Line 9500 Series (SilverStar)(Cont'd.)

98 -	All Models with 12000 lb, 13200 lb or 14600 lb Axle and 60" Taperleaf Spring	F6HT-18045-EB	010	85055	89439
		F6HT-18045-EC	010	85055	89439
98 -	All Models with 13200 lb or 14600 lb Axle and 54" Taperleaf Spring	F6HT-18045-GC	010	85030	89440
98 -	All Models with 14600 lb or 16000 lb Axle and 54" Multi-leaf Spring	F6HT-18045-CC	010	85055	89439
98 -	All Models with 23000 lb Axle and 52" Taperleaf Softride Rear Suspension	F6HT-18080-CA		010	85314 89425
98 -	All Models with Hendrickson 40LH Tandem Axle	57241-2		01-	83109 ...
98 -	All Models with Hendrickson HAS Rear Air Suspension	47902-28		010	85013 89414
		F6HT-18080-FC		010	85013 89414
98 -	Models with FAS II Rear Air Suspension	16-15817-000		010	85724 89443

ACTERRA

09 - 10	Models with 10000 to 12000 lb. Front Axle and 3" Taper-leaf Suspension	10-13592-000	010	85959
		SDA47170000440	010	85959
03 -	Models with 10000 to 12000 lb. Taper-leaf Spring Suspension	10-12390-000	010	85920
	Models with 11000 to 12000 lb Front axle	6803230300	010	85006
	Models with 15000 lb Rear Suspension	6803260000		01-	83120 ...
- 02	Models with 6000 to 9000 lb Front axle	6803230200	010	85043
03 - 08	Models with 6000 to 9000 lb Front axle	10-12388-000	010	85920
03 - 10	Models with FAS II Rear Air Suspension	16-15817-000		010	85724 89443
		16-18708-000		010	85724 89443
		471700002809		010	85724 89443
		680611		010	85724 89443
		SDA471700002809		010	85724 89443
- 04/09	Models with Hendrickson Airtex Suspension	58913-003	010	85932	89453

Cargo Line

98	SC-7000 or SC-8000 Models with 12000 or 13000 lb. Axles	F6HT-18045-LA	010	85376
98	SC-7000 or SC-8000 Models with 16000 lb. Multileaf Spring	F6HT-18045-AA	010	85054	89438









L - Line 7500 Series - Short Haul Tractor

	Models with 10000 lb Front Axle	F6HT-18045-KA	010	83200	89402
--	---------------------------------	---------------	-----	-------	-------	-----	-----

L - Line 8500 Series - Conventional Cab

98	All Models with 10000 lb or 12000 lb Axle and 54" Taperleaf Spring	F6HT-18045-AC	010	85054	89438
98 -	All Models with 12000 lb or 13200 lb Axle and 54" Multileaf Spring	F6HT-18045-BC	010	85047	89435
98 -	All Models with 12000 lb, 13200 lb or 14600 lb Axle and 60" Taperleaf Spring	F6HT-18045-EB	010	85055	89439
		F6HT-18045-EC	010	85055	89439
98 -	All Models with 13200 lb or 14600 lb Axle and 54" Taperleaf Spring	F6HT-18045-GC	010	85030	89440
98 -	All Models with 14600 lb or 16000 lb Axle and 54" Multi-leaf Spring	F6HT-18045-CC	010	85055	89439
98 -	All Models with 23000 lb Axle and 52" Taperleaf Softride Rear Suspension	F6HT-18080-CA		010	85314 89425
98	All with Hendrickson HAS Rear Air Suspension	47902-28		010	85013 89414
		F6HT-18080-FC		010	85013 89414
98	LT-8000 Models with 12000 or 13000 lb Axles	F6HT-18045-LA	010	85376
98	LT-8000 Models with 16000 lb. Multileaf Spring	F6HT-18045-AA	010	85054	89438
98	LT-8501 (101" BBC) Models with 8500 or 9000 lb Axle and 54" Multileaf Spring	F6HT-18045-JB	010	83200	89402
		F6HT-18045-JC	010	83200	89402

APPLICATION GUIDE - TRUCKS, TRAILERS, AND BUSES

Year Año Année	Model Modelo Modèle	OEM #	Front		Rear	
						
						
			Fleetline	GasSLX	Fleetline	GasSLX

STERLING TRUCK(Cont'd.)

L - Line 8500 Series - Conventional Cab(Cont'd.)

	LT-8501 (101" BBC) Models with 8500 or 9000 lb Axle and 54" Taperleaf Spring	F6HT-18045-HB	010	85054	89438	
		F6HT-18045-HC	010	85054	89438	
99 - 10	Models with FAS II Rear Air Suspension	16-15817-000 680611		010	85724	89443
98	Models with Hendrickson 40LH Tandem Axle	57241-2		01-	83109	...





L - Line 9500 Series - Conventional Cab

98	All Models with 10000 lb or 12000 lb Axle and 54" Taperleaf Spring	F6HT-18045-AC	010	85054	89438	
98 -	All Models with 12000 lb or 13200 lb Axle and 54" Multileaf Spring	F6HT-18045-BC	010	85047	89435	
98 -	All Models with 12000 lb, 13200 lb or 14600 lb Axle and 60" Taperleaf Spring	F6HT-18045-EB	010	85055	89439	
		F6HT-18045-EC	010	85055	89439	
98 -	All Models with 13200 lb or 14600 lb Axle and 54" Taperleaf Spring	F6HT-18045-GC	010	85030	89440	
98 -	All Models with 14600 lb or 16000 lb Axle and 54" Multi-leaf Spring	F6HT-18045-CC	010	85055	89439	
98 -	All with 23000 lb Axle and 52" Taperleaf Softride Rear Suspension	F6HT-18080-CA		010	85314	89425
98 -	All with Hendrickson HAS Rear Air Suspension	47902-28 F6HT-18080-FC		010	85013	89414
				010	85013	89414
98 -	LT-9501, LT-9511, LT-9513 or LT-9513 (113" & 122" BBC) Models with 8500 or 9000 lb Axle and 54" Multileaf Spring	F6HT-18045-JB	010	83200	89402	
		F6HT-18045-JC	010	83200	89402	
98 -	LT-9501, LT-9511, LT-9513 or LT-9513 (113" & 122" BBC) Models with 8500 or 9000 lb Axle and 54" Taperleaf Spring	F6HT-18045-HB	010	85054	89438	
		F6HT-18045-HC	010	85054	89438	
99 - 10	Models with FAS II Rear Air Suspension	16-13957-000		010	85724	89443
98 -	Models with Hendrickson 40LH Tandem Axle	57241-2		01-	83109	...

Additional O.E.M. Interchanges

	Models with Link Rear Air Suspension	1210-0528		010	85904	...
	Models with Neway Rear Suspension	90045099		010	85906	89407
	Models with O.E.M. Number	16-15770-000		010	85956	...
		4C4Z-18124-N	010	85957
		4C4Z-18125-DA		010	85926	...
		6E7Z-18125-A		010	83146	...
		AT-560	010	G63809
		AX-267A	010	83309	89446	
		AX-310		010	83215	...
		C4HZ-18124-E	010	83309	89446	
		C4TZ-18124-AB	010	83308
		D8HZ-18124-A	010	85301
		E6HZ-18124-A	010	85301
		E6HZ-18124-D	010	85301
		E6HZ-18125-D		010	83215	...
		E7HZ-18124-A	010	85301
		E7XZ-18124-A	-10	G63386
		E7XZ-18125-B		-10	G63387	...
		E9HZ-18124-A	010	83309	89446	
		F0HZ-18124-B	010	85006
		F1HZ-18124-A	010	83309	89446	
		F1HZ-18124-B	010	83308
		F1HZ-18124-D	010	85006	89401	

APPLICATION GUIDE - TRUCKS, TRAILERS, AND BUSES

Year Año Année	Model Modelo Modèle	OEM #	Front		Rear	
			 Fleetline	 GasSLX	 Fleetline	 GasSLX

STERLING TRUCK(Cont'd.)

Additional O.E.M. Interchanges(Cont'd.)

Year	Model	OEM #	Front	Rear
	Models with O.E.M. Number	F1HZ-18124-E	010 85006 89401	...
		F1HZ-18124-H	010 85040
		F1HZ-18124-J	010 83308
		F1HZ-18124-K	010 ... 89402	...
		F2HZ-18124-A	010 85376
		F2HZ-18124-B	010 85301
		F4HT-18080-AB 010 85314 89425	...
		F4HT-18080-BA 010 85001 89410	...
		F5HZ-18124-A	010 83314
		F5HZ-18124-B	010 83107
		F5HZ-18124-C	010 85063
		F5HZ-18124-D	010 83125
		F5HZ-18125-A 010 85314 89425	...
		F5HZ-18125-B 010 85001 89410	...
		F6HT-18045-GB	010 85030 89440	...
		F6HT-18080-B 01- 83109
		F6HT-18080-DA 01- 83109
		F6HT-18080-EA 010 85906 89407	...
		F6HT-18124-JC	010 83200 89402	...
		F6HT-18124-KA	010 83200 89402	...
		F6HZ-18124-A	010 85054 89438	...
		F6HZ-18124-B	010 83308
		F6HZ-18124-C	010 85055 89439	...
		F6HZ-18124-D	010 85055 89439	...
		F6HZ-18124-E	010 85055 89439	...
		F6HZ-18124-F	010 85055 89439	...
		F6HZ-18124-G	010 85054 89438	...
		F6HZ-18124-H	010 85054 89438	...
		F6HZ-18124-J	010 83200 89402	...
		F6HZ-18125-B 01- 83109
		F6HZ-18125-D 010 85013 89414	...
		F81A-18045-AGB	010 G63809
		XC45-18045-AA	010 83216

L - Line 9500 Series - Conventional Cab

99 - 10	Models with FAS II Rear Air Suspension	XC45-18080-BA	010 85724 89443
---------	--	---------------	-----	-----	-----------------









STERLING TRUCK CAB SHOCKS

	8500 & 9500 Models with 113" & 122" BBC Conventional Tractors with Link Cabmate Models FH1322 & FH1322-A	1202-1043	010	83025
	AT-9500 Models with O.E.M. Number	F6HZ-5K407-BA	010	83033
		F8HT-5K407-AA	010	83033
	L8501 & L9501 Models with 101" BBC Conventional Tractors with Link Cabmate Model FH101	1202-1043	010	83025
	LT-9500 Models with O.E.M. Number	F6HZ-5K407-AB	010	83034
	Models with O.E.M. Number	18-45067-000	010	83034

ACTERRA

03 - 10	Acterra Models with O.E.M. Number	18-43504-000	010	83057
		18-60768-000	010	83057
		18-814903003484	010	83057

APPLICATION GUIDE - TRUCKS, TRAILERS, AND BUSES

Year Año Année	Model Modelo Modèle	OEM #	Front		Rear	
						
						
			Fleetline	GasSLX	Fleetline	GasSLX

STOUGHTON TRAILERS INC.

	Trailers with Hendrickson HT190T, HT190U, & HS190T Models Air Suspension	HTA20001		OIO	83128	89436
	Trailers with Hendrickson HT230T Models Air Suspension	HTA20002		OIO	85000	89436
	Trailers with Neway AR-90-1-12, -14, -17 Models Air Suspension	NW90044162		OIO	83128	89436
	Trailers with Neway AR-90-1-15, -16 Models Air Suspension	NW90044448		OIO	85051	...
	Trailers with Neway RL-196-14, -15, Models Air Suspension	NW90044978		OIO	85059	...
	Trailers with Neway RL-196-16, -17, Models Air Suspension	NW90044979		OIO	83113	...
	Trailers with Reyco 86AR/RS1015 Air Ride Suspension	RT18165-01		OIO	85006	...
	Trailers with Reyco 86AR/RS1035 Anti-Dock Walk Air Suspension	RT18165-01		OIO	85006	...

SUSPENSYS

	FS230 Trailer Suspension (Light Duty)	218004872		OIO	85737	...
--	---------------------------------------	-----------	--	-----	-----	-----	--------------	-----





THE BINKLEY COMPANY

97	Trailers with Binkley AirLite Suspension	16965		OIO	85006	...
		6898		OIO	83125	...

THOMAS SCHOOL BUS

	Buses with Neway Tandem Air Suspension	61310232		OIO	85000	89436
	Buses with O.E.M. Number	16-19138-000	OIO	85058	89431	
	Model MVP	61310101		85736	...	OIO	85736	...
06 - 15	Models with Freightliner CC B2 Bus Chassis	10-13634-000	OIO	85918	89449	
		16-15817-000		OIO	85724	89443
		16-18708-000		OIO	85724	89443
	ROC Front, SAF-T-Liner	61300285	-I-	83102
		GBL651442	-I-	83102
	SAF-T-Liner HDX Models with Hendrickson Comfort Air Rear Air Suspension	471700131545		OIO	85006	...
		60998-001		OIO	85006	...
		60998-003		OIO	85006	...
	SAF-T-Liner School Bus MVP-ER & MVP-EF	61300219	OIO	85091
		61300222	OIO	85091
		61300223	OIO	85091
		70445	OIO	85091
2009	SAF-T-Liner School Bus with SAF Holland AD-246 Suspension	90045504	OIO	85030
2009	SAF-T-Liner School Bus with SAF Holland AD-369 Suspension	90045504	OIO	85030
	School Bus	300-0614966		OIO	85307	...
		614966		OIO	85307	...
		614974	OIO	85304
		680010	OIO	85304
		680054		OIO	85307	...
07 - 12	Type C Conventional Buses (65 capacity) with 12000 lb Taperleaf Front Suspension	10-13634-000	OIO	85918	89449	
- 17	Type C Conventional Buses (65 capacity) with FAS II Rear Air Suspension	16-15817-000		OIO	85724	89443
		16-18708-000		OIO	85724	89443
		61310434		OIO	85724	89443
		61310478		OIO	85724	89443
2003	Type C Conventional School buses (65 capacity) with O.E.M. Number	680-323-0300	OIO	85006
		GBL665538	OIO	85006
09-12	Type C School bus chassis with O.E.M. Number	16-18713-000		OIO	85122	...

APPLICATION GUIDE - TRUCKS, TRAILERS, AND BUSES

Year Año Année	Model Modelo Modèle	OEM #	Front		Rear	
						
			Fleetline	GasSLX	Fleetline	GasSLX

THOMAS SCHOOL BUS(Cont'd.)

09-12	Type C School bus chassis with O.E.M. Number	471700003070		01-	85122	...
	Models with O.E.M. Number	128745	-1-	83102
		60670-006		010	83147	...
		61300112	-1-	83613
		61300224	010	85918	89449	
		61300240	010	85918	89449	
		61310102		010	85308	89422
		61310103		010	85308	89422
		651442	-1-	83102
		659287	-1-	83102
		680-326-0000		01-	83120	...
		GBL654725		01-	83120	...
		Additional O.E.M. Interchanges	6130-0114	010				89437
6130029	010					85712		
61310104	010					85713		
63-0001	010					85713		
680088	010					85713		
680102	010					85712		
728802	010					85736		
87002	010					85736		
A-4890	010					85712		

Type A School Bus









92 - 17	Minotour Type A School bus with Ford E350 Chassis	8C24-18045-DA	-10	83177
		8C2Z-18124-D	-10	83177
		ASH-1154	-10	83177
		AT-163G	-10	83177
		8C24-18080-DB		-10	83178	...
		8C2Z-18125-D		-10	83178	...
		ASH-1136		-10	83178	...
		AT-164G		-10	83178	...
00 - 17	Minotour Type A School bus with Ford E450 Chassis	8C24-18045-DA	-10	83177
		8C2Z-18124-D	-10	83177
		ASH-1154	-10	83177
		AT-163G	-10	83177
		8C24-18080-DB		-10	83178	...
		8C2Z-18125-D		-10	83178	...
		ASH-1136		-10	83178	...
		AT-164G		-10	83178	...

THOR MOTOR COACH

Class A MotorHomes

06	Astoria & Tuscany Series MotorHomes with Freightliner XC Chassis	ADL200 Suspension w/ 20K Rear AS120 Front Suspension	16-16873-000		010	85029	...
			141700131810	010	83160
			16-16737-000	010	83160
			16-16874-000	010	83160
			Rear Shock with O.E.M. Number		010	85029	...
			141700131809		010	85029	...
			16-16736-000		010	85029	...
			ZF - IFS Front Suspension with 23,000 lb GVW or Greater		010	85029	...
			16-18103-000	-1-	85900
			481700000493	-1-	85900

APPLICATION GUIDE - TRUCKS, TRAILERS, AND BUSES

Year Año Année	Model Modelo Modèle	OEM #	Front		Rear	
						
						
			Fleetline	GasSLX	Fleetline	GasSLX

THOR MOTOR COACH(Cont'd.)

Class A MotorHomes(Cont'd.)

02 - 05	Escaper & UltraSport Series MotorHomes with Freightliner XC Chassis	OEM #	Front	Rear	Fleetline	GasSLX
	ADL200 Suspension w/ 20K Rear	16-16873-000	010	85029
	AS120 Front Suspension	141700131810	010	83160
		16-16737-000	010	83160
		16-16874-000	010	83160
	Rear Shock with O.E.M. Number	141700131809	010	85029
		16-16736-000	010	85029
	ZF - IFS Front Suspension with 23,000 lb GVW or Greater	16-18103-000	-1-	85900
		48170000493	-1-	85900

TIMBREN INDUSTRIES

Additional O.E.M. Interchanges	665804	010	85939
--------------------------------	--------	-----	--------------

TRAIL KING INDUSTRIES

Identification of the trailer suspension is necessary to determine what section of the catalog to refer to. Some possible options can be Chalmers, Hendrickson, Neway, Ridewell, Reyco.

TRAILMOBILE CANADA CORP.

Description	OEM #	Front	Rear	Fleetline	GasSLX
Trailers with Granning Air Susp. T-350A	43-8-022	010	83225
Trailers with Hendrickson Air Susp. HT230T (23,000 lb Capacity)	43-6-118	010	85000 89436
Trailers with Hendrickson Air Susp. HT250U, HT250U-Y	A-2212	010	85029
Trailers with Hendrickson Air Susp. T23-RL-17	43-8-011	010	83207 89407
Trailers with Hendrickson Air Susp. T23-US-6 (Non-Liftable)	43-8-015	010	85006
Trailers with Hendrickson Air Susp. T23-US-9 (Liftable & Non-Liftable)	43-8-014	010	85013 89414
Trailers with Hendrickson Air Susp. T30-US-9, -12, -14, -17	43-8-013	010	85000 89436
Trailers with Neway Air Susp. AR90-1-14, AR90-1-17	90044089	010	83124 89407
Trailers with Neway Air Susp. AR90-14, -17,	90044089	010	83124 89407
Trailers with Neway Air Susp. AR92-14	90044992	010	85000 89436
Trailers with Neway Air Susp. AR92-17	90044642	010	83127
Trailers with Neway Air Susp. AR93-14	90045054	010	85051
Trailers with Neway Air Susp. AR93-17	90044089	010	83124 89407
Trailers with Neway Air Susp. AR95-9-HD, -12-HD,-14-HD, 17-HD	90044625	010	83125
Trailers with Neway Air Susp. RL196-12	90044977	010	83115
Trailers with Neway Air Susp. RL196-14, -15	90044978	010	85059
Trailers with Neway Air Susp. RL196-16, -17	90044979	010	83113
Trailers with Reyco Air Susp. Model # 21AR (25,000 LB Capacity)	43-8-002	010	83209 89414
Trailers with Reyco Air Susp. Model # 74AR (30,000 LB Capacity)	43-8-002	010	83209 89414
Trailers with Reyco Air Susp. Model # 86AR	43-8-015	010	85006
Models with O.E.M. Number	43-4-235	010	85051
	43-4-236	010	85029
	43-4-237	010	85000 89436
	43-4-239	010	83207 89407
	43-4-241	010	85006
	43-4-277	010	85000 89436
	43-4-278	010	85059
	43-4-279	010	83204
	43-6-028	010	85000 89436
	43-6-137	010	85006

APPLICATION GUIDE - TRUCKS, TRAILERS, AND BUSES

Year Año Année	Model Modelo Modèle	OEM #	Front			Rear			
			Fleetline	GasSLX				Fleetline	GasSLX

TRAILMOBILE CANADA CORP.(Cont'd.)

Models with O.E.M. Number	43-6-158		OIO	85013	89414
	43-6-164		OIO	83207	89407
	43-8-031		OIO	85029	...

TRANSPORTATION MFG. CORP

City Cruiser	12TA-01-13			85303	...	OIO	85303	89422
Drive Axle	12J-5-10		OI-	85733	...	
	12J-5-2		OI-	85312	...	
	12J-5-4		OI-	85312	...	
G 4500 Coach (Front) 45 ft Coach -Tag Axle Tag Axle	12-05-6000	-IO	85711	
	12-05-6033		OIO	85339	...	
	12-05-6002		OIO	85339	...	
Low Floor Bus Models with O.E.M. Number	12L-5-99		OIO	85339	...	
RTS Bus with "V" Drive Rear	G1101590		OIO	85713	...	
RTS Bus with Normal Front	22012079	-I-	85701	
	4975515	-I-	85701	
	695117	-I-	85701	
	74410	-I-	85701	
RTS Bus with Regular Rear	22045526		OIO	85702	...	
	22052014		OIO	85702	...	
	G1011822		OIO	85702	...	
RTS Bus with Solid Front Axle	22024673	-IO	85710	
	22046485	-IO	85710	
	680350	-IO	85710	
	695273	-IO	85710	
	695279	-IO	85710	
Tag Axle	12J-5-11		OIO	85313	...	
	12J-5-3		OIO	85313	...	
	12J-5-6		OIO	85313	...	
	12J-5-9		OIO	85700	...	
Models with O.E.M. Number	12B-5-1		OIO	85735	...	
	12G-5-1	OIO	85700	
	12T-1-13		85303	...	OIO	85303	89422	
	680349		OIO	85702	...	
	680470		OIO	85713	...	
Additional O.E.M. Interchanges	12L-5-69	OIO	85700					
	12L-5-70	OIO	85700					

TRINITY TRAILER MFG., INC.

Identification of the trailer suspension is necessary to determine what section of the catalog to refer to. Some possible options can be Chalmers, Hendrickson, Neway, Ridewell, Reyco.							
---	--	--	--	--	--	--	--

TURNER-QUICK LIFT - SEE HENDRICKSON SUSPENSION









--	--	--	--	--	--	--	--

TUTHILL TECHNOLOGIES

Drive Axle

101A, 101AR Models	18166-01		OIO	85704	...
102AR (Hvy Duty) Models	18286-01		OIO	...	89414
102AR (Special) Models	17146-01		OIO	83209	89414
102AR (Standard) Models	12887-02		OIO	85013	89414

APPLICATION GUIDE - TRUCKS, TRAILERS, AND BUSES

Year Año Année	Model Modelo Modèle	OEM #	Front		Rear	
						
						
			Fleetline	GasSLX	Fleetline	GasSLX

TUTHILL TECHNOLOGIES(Cont'd.)

Drive Axle(Cont'd.)

102AR for Western Star Models	19824-01		OIO	85006	...
102AR-7 Models	17794-01		OIO	83215	...
102AR-LM Models	19623-01		OIO	83123	89405
200 Models Air Suspension	20129-01		OIO	85007	89412
240AR Air-Ride Suspension With O.E.M. Number	20125-01		OIO	85030	89440
	20126-01		OIO	...	89440
74AR - 30000 lb Capacity	12887-01		OIO	85013	89414
79KB Models	16725-01		OIO	83221	...

Steer Axle

1207 Models	17403-01	OIO	83122	89406	
1209 (Alternate) Models	17408-01	OIO	85005	89430	
1209, 1212 Models	17358-01	OIO	83126	89430	
	19495-01	OIO	83126	89440	
21B Models	14954-01	OIO	83217

Trailer

21B (Special) Models	18800-01		OIO	83203	89436
25 ART Models with O.E.M. Number	24392-01		OIO	85051	...
25 ARU Models with O.E.M. Number	23553-01		OIO	85938	...
30 ARUUL - 12 and -17 Models	23524-01		OIO	85738	...
81S Models	12885-03		OIO	85300	89419
86 AR / RS 1015, 1035, 3035 Slider Air Suspension	18165-01		OIO	85006	...
87 for Great Dane Models	18163-01		OIO	83207	89407
	18164-01		OIO	83122	89406
87-14 (Rear Mount) Models	18146-01		OIO	85313	...
87-14, -17 Models	16230-01		OIO	85702	...
87-6, 87-9 Models	12885-01		OIO	85300	89419
Models with O.E.M. Number	1085		OIO	83214	...
	16824-01		OIO	85006	...
	17142-01		OIO	85001	89410
	20960-01		OIO	83204	...
	21497-01		OIO	85005	89430
	23614-01		OIO	85717	...
	2697		OIO	85712	...
	680162		OIO	85300	89419
	702135-01		OIO	85045	...
	702136-01		OIO	85052	...
	702209-01		OIO	85014	...
OE12425		OIO	83214	...	





TWIN COACH

Models with O.E.M. Number	90044089		OIO	83124	89407
	90044089C		OIO	83124	89407
	90044162		OIO	83128	89436
	AR-718-C-HD		OIO	85000	89436
	AR-958		OIO	83207	89407

UNITED MANUFACTURING

Models with O.E.M. Number	K-96-41		OIO	85304	...
---------------------------	---------	--	-----	-----	-----	-------	-----

APPLICATION GUIDE - TRUCKS, TRAILERS, AND BUSES

Year Año Année	Model Modelo Modèle	OEM #	Front		Rear	
						
			Fleetline	GasSLX	Fleetline	GasSLX

UNIVERSAL COACH

Models with O.E.M. Number	12-05-1199		01-	85729	...
	680777		01-	85729	...

UPS TRUCK

Models with O.E.M. Number	P117099		01-	83120	...
	P117146	010	83118

UTILITY TRAILER MANUFACTURING COMPANY

Identification of the trailer suspension is necessary to determine what section of the catalog to refer to. Some possible options can be Chalmers, Hendrickson, Neway, Ridewell, Reyco.

Flatbeds

4000A Model Trailers with Hendrickson AANT 23K Intraax Air Ride (High Damping) (Hvy Duty) (Limited Rebound) (Standard)	B-24023 B-24125 B-23361 B-23566		010	85738	...
			010	85323	89436
			010	85911	...
			010	85000	89436
Drop Deck Trailers with Hendrickson AANL 23K Intraax Air Ride with 12" to 17" Ride Height - High Damping with 6.5" to 9" Ride Height - High Damping with 6.5" to 9" Ride Height - Standard	B-25515 B-24579 B-23651		010	85338	...
			010	85939	...
			010	85045	...





Reefers & Dry Vans

3000R Multi-Temp Trailers with Hendrickson HKANT 40K Vantraax Air Ride Heavy Duty	B-24088 S-24088		010	85000	89436
Standard	B-24088 S-24088		010	83128	89436
4000D Trailers with Hendrickson HKANT 40K Vantraax Air Ride Heavy Duty	B-24088 S-24088		010	85000	89436
Standard	B-24088 S-24088		010	83128	89436
4000D-X Composite Trailers with Hendrickson HKANT 40K Vantraax Air Ride Heavy Duty	B-24088 S-24088		010	85000	89436
Standard	B-24088 S-24088		010	83128	89436

VAN HOOL

00 - 09	T2145 and T2150 Buses with O.E.M. Number (Front & Tag Axle)	10685703 624314570 90-2291		- -	695406	...
				- -	695406	...
				- -	695406	...
	T811, T812, T813, T814 Buses	6243-14040 665563		85708	...	- -	85708	...
				85708	...	- -	85708	...
	T815 4D Buses	6243-14040 665563		- -	85708	...
				- -	85708	...
00 - 09	T940 and T945 Buses	624314570 90-2291		- -	695406	...
				- -	695406	...
	TL 13/14 Buses	6243-13790		85708	...	- -	85708	...

APPLICATION GUIDE - TRUCKS, TRAILERS, AND BUSES

Year Año Année	Model Modelo Modèle	OEM #	Front		Rear	
						
			Fleetline	GasSLX	Fleetline	GasSLX

VAN HOOL(Cont'd.)

	TL 13/14 Buses	665562		85708	...	- -	85708	...
--	----------------	--------	--	--------------	-----	-----	--------------	-----

VOLVO

FE Series

	FE6 Models	6857668	- O	83105
		6876828	- O	83105
	FE611, FE614 Front after CH419306	6794358	O O	85040
	FE614 Tractor	6790756		O O	83215	...
		6794358	O O	85040
	FE615, FE715	6772218	O O	85040
		6775412	O O	85040
	FE7 Models up to Chassis No. 20855	1505190		- -	85722	...
	FE7 Models with over 6.5 Front Axle (Ton)	1590439	O O	83104
	FE7 Models with Rear Air Suspension (Drive Axle)	1591501		- -	85722	...
	FE715 with Rear Parabolic Spring	6790756		O O	83215	...
	Models with Rear Air Suspension and O.E.M. Number	8056892		O O	85023	89415

N Series

	N10 with 5.5 Ton Front Axle	1593843	O O	83215
	N11 Models	1-0200-32-888-1	O O	83104
		1591735	O O	83104
		1593843	O O	83215
	N12 Models	1-0200-32-888-1	O O	83104
		1591735	O O	83104
		1593843	O O	83215
	N12 with over 6.5 Ton Front Axle	1590439	O O	83104

VAH Series

	VAH 430 Models with Hendrickson HAS 400 or 460 Series Rear Suspension	60675-001		O O	85978	...
		8083872		O O	85978	...
2014	VAH 430 Models with O.E.M. Number	141700005838	O O	85098
		21436086	O O	85098









VHD - Series

08 - 17	Models with 12,000 to 22,000 lb Front Axles	20353932	O -	85081
		20414440	O -	85081
		20433426	O -	85081
		20434880	O -	85081
		471700131258	O -	85081
		SDA471700131258	O -	85081
- 17	Models with Hendrickson 40,000 lb Pimaax EX and FireMaax EX Air Suspension	20782199		O O	85072	...
		60657-007		O O	85072	...
	Models with Neway ADZ Rear Suspension	471700004423		O O	85109	...
		90045605		O O	85109	...
08 - 17	Models with T-Ride Rear Suspension	20433427		O -	85065	...
		471700131256		O -	85065	...

VN Series - 2200

05/99 -	Models built after May 1999	20433425		O O	85066	89448
		471700002627		O O	85066	89448
		8086651		O O	85066	89448
	Models with O.E.M. Number	20433424	O O	85061	89450	
		20513881	O O	85061	89450	
		20551628		O O	85066	89448

APPLICATION GUIDE - TRUCKS, TRAILERS, AND BUSES

Year Año Année	Model Modelo Modèle	OEM #	Front		Rear	
						
						
			Fleetline	GasSLX	Fleetline	GasSLX

VOLVO(Cont'd.)





VN Series - 2200(Cont'd.)

	Models with O.E.M. Number	47170000443 665607 8077874 8077874-P01 8078195 8086053 8169859		OIO	85066	89448
				OIO	85047	89435
				OIO	85047	89435
				OIO	85047	89435
				85061	89450	
				OIO	85047	89435
				OIO	85047	89435

VNL Series

06 - 16	300 Models with Hendrickson 40,000 lb Pimaax EX and FireMaax EX Air Suspension	20782199 60657-007		OIO	85072	...
				OIO	85072	...
06 - 10	300, 300U Models with 12,000 - 13,200 lb Front Axles	20433424	OIO	85061	89450	
11 - 17	300, 300U Models with 12,000 - 13,200 lb Front Axles	141700005838 21436086	OIO	85098
			OIO	85098
06 - 11	300, 300U Models with 40,000 lb Rear Air Suspension	20433425 20551628 47170000443 471700002627		OIO	85066	89448
				OIO	85066	89448
				OIO	85066	89448
				OIO	85066	89448
11 - 17	300, 300U Models with 40,000 lb Rear Air Suspension	21462378 471700006038		OIO	85088	...
				OIO	85088	...
06 - 14	300, 300U Models with Hendrickson Airtek	20485632 20485633 21137330 471700003832 64838-003	OIO	85933	89454	
			OIO	85933	89454	
			OIO	85933	89454	
			OIO	85933	89454	
			OIO	85933	89454	
11 - 17	430 Models with 12,500 - 14,600 lb Front Axle	141700005838 21436086	OIO	85098
			OIO	85098
06 - 10	430 Models with 13,200 lb Front Axle	20433424	OIO	85061	89450	
05 - 11	430 Models with 40,000 lb Rear Air Suspension	20433425 20551628 47170000443 471700002627		OIO	85066	89448
				OIO	85066	89448
				OIO	85066	89448
				OIO	85066	89448
11 - 17	430 Models with 40,000 lb Rear Air Suspension	21462380 471700006040		OIO	85088	...
				OIO	85088	...
05 - 14	430 Models with Hendrickson Airtek	20485632 20485633 21137330 471700003832 64838-003	OIO	85933	89454	
			OIO	85933	89454	
			OIO	85933	89454	
			OIO	85933	89454	
			OIO	85933	89454	
11 - 17	630 & 670 Models with 12,500 - 14,600 lb Front Axle	141700005838 21436086	OIO	85098
			OIO	85098
06 - 10	630 & 670 Models with 13,200 lb Front Axle	20433424	OIO	85061	89450	
06 - 11	630 & 670 Models with 40,000 lb Rear Air Suspension	20551628 47170000443		OIO	85066	89448
				OIO	85066	89448
11 - 17	630 & 670 Models with 40,000 lb Rear Air Suspension	21462380 471700006040		OIO	85088	...
				OIO	85088	...
06 - 16	630 & 670 Models with Hendrickson Airtek	20485632 20485633 21137330 471700003832 64838-003	OIO	85933	89454	
			OIO	85933	89454	
			OIO	85933	89454	
			OIO	85933	89454	
			OIO	85933	89454	

APPLICATION GUIDE - TRUCKS, TRAILERS, AND BUSES

Year Año Année	Model Modelo Modèle	OEM #	Front		Rear	
						
			Fleetline	GasSLX	Fleetline	GasSLX

VOLVO(Cont'd.)

VNL Series(Cont'd.)

06 - 16	64T-830 Models with Hendrickson 40,000 lb Pimaax EX and FireMaax EX Air Suspension	20782199		O O	85072	...
06 - 16	64T-830 Models with Hendrickson 40,000 lb Primaax, Pimaax EX and FireMaax EX Air Suspension	60657-007		O O	85072	...
11 - 17	730 & 780 Models with 12,500 - 14,600 lb Front Axle	141700005838	O O	85098
		21436086	O O	85098
06 - 10	730 & 780 Models with 13,200 lb Front Axle	20433424	O O	85061	89450	
06 - 11	730 & 780 Models with 40,000 lb Rear Air Suspension	20551628		O O	85066	89448
		471700000443		O O	85066	89448
11 - 17	730 & 780 Models with 40,000 lb Rear Air Suspension	21462380		O O	85088	...
		471700006040		O O	85088	...
06 - 16	730 & 780 Models with Hendrickson Airtek	20485632	O O	85933	89454	
		20485633	O O	85933	89454	
		21137330	O O	85933	89454	
		471700003832	O O	85933	89454	
		64838-003	O O	85933	89454	
06 - 10	All Models with 12,000 - 13,200 lb Front Axles	20433424	O O	85061	89450	
		8071881	O O	85061	89450	
05/99 -	Models with 38,000 lb Rear Air Suspension built after May 1999	20433425		O O	85066	89448
		471700002627		O O	85066	89448

VNM Series

- 17	200 Models with 12,000 lb Front Axles	21436086	O O	85098
- 16	200 Models with 46,000 lb T-Ride Rear Suspension	20433427		O -	85065	...
- 17	430 Models with 12,500 lb Front Axle	21436086	O O	85098
- 17	630 Models with 12,500 lb Front Axle	21436086	O O	85098
- 17	630 Models with 38,000 lb Rear Air Suspension	21462378		O O	85088	...
		21462380		O O	85088	...

VNX - Series

	Models with Neway ADZ Rear Suspension	471700004423		O O	85109	...
		90045605		O O	85109	...

Vocational Trucks

	Models with T-Ride Rear Suspension	20433427		O -	85065	...
		8060026		O -	85065	...
		8073212		O -	85065	...
		8075257		O -	85065	...
	WX, WXR, WG, AC Models with Hendrickson HN-402 Rear Suspension	57241-3		O -	83112	...
	WX, WXML, WXR, WG, AC Models With Hendrickson HAS-400 Rear Air Suspension With Hendrickson HAS-460 Rear Air Suspension With Hendrickson HN-462 Rear Suspension	47902-24		O O	83137	...
		47902-24		O O	83137	...
		57241-3		O -	83112	...









VT Series

06 - 10	64T-830 Models with 40,000 lb Rear Air Suspension	20551628		O O	85066	89448
		471700000443		O O	85066	89448
06 - 16	64T-830 Models with Hendrickson 40,000 lb Primaax, Pimaax EX and FireMaax EX Air Suspension	60657-007		O O	85072	...
06 - 16	64T-880 Models with Hendrickson 40,000 lb Pimaax EX and FireMaax EX Air Suspension	20782199		O O	85072	...
06 - 10	All Models with 12,000 - 13,200 lb Front Axles	20433424	O O	85061	89450	
		8071881	O O	85061	89450	

WCA & WIA Series

95 -	All with O.E.M. Number and after V.I.N. Number 723506	8169859		O O	85047	89435
------	---	---------	--	-----	-----	-----	-------	-------

APPLICATION GUIDE - TRUCKS, TRAILERS, AND BUSES

Year Año Année	Model Modelo Modèle	OEM #	Front		Rear	
						
						
			Fleetline	GasSLX	Fleetline	GasSLX

VOLVO(Cont'd.)

WCA & WIA Series(Cont'd.)

	Models with Front Dual Shocks	02-7005976 3082284	- -	83400
			- -	83400
93 - 95	Models with O.E.M. Number and after V.I.N. Number 657841	8026658		O O	85046	89434
- 92	Models with O.E.M. Number and up to V.I.N. Number 657250	8071524		O O	85024	89416
	Models with O.E.M. Number	37301-0016 37301-0021 37301-3201 37301-3202 4975549 8065787	O -	85026	89417	
			O -	85026	89417	
			- -	85027	89418	
			O -	85026	89417	
			O O	83216
			O -	85026	89417	

WG Series

	Models with O.E.M. Number	35901-3201 37301-3201 665623	- -	O O	85024	89416
			- -	85027	89418	
				O O	85046	89434
- 92	Models with O.E.M. Number	8065787 8071524	O -	85026	89417	
				O O	85024	89416
93 - 95	Models with O.E.M. Number	8026658		O O	85046	89434





WH Series

	WHS, WHR, WHL or WHE Models with Front Dual Shocks	02-7005976 3082284	- -	83400
			- -	83400
	WHS, WHR, WHL or WHE Models with Front Single Shocks	37301-0021	O -	85026	89417	
- 92	WHS, WHR, WHL or WHE Models with O.E.M. Number	35901-3201 8071524		O O	85024	89416
				O O	85024	89416
93 - 95	WHS, WHR, WHL or WHE Models with O.E.M. Number	8026658		O O	85046	89434
95 -	WHS, WHR, WHL or WHE Models with O.E.M. Number	8169859		O O	85047	89435

Additional Applications

	1500 Models		83122	...	O O	83122	89406
	1500 Models							
	Models with Rear Suspension	35901-0005		O O	83219	...
	Models with Velvet Ride Suspension	530596		O O	85308	89422
	3000, 4000 & 9000 Models - Special Unit - Four Shock Absorbers Required Per Axle	5554959 676081 676082	O O	83401
			O O	83401
			O O	83401
	3014, 3015, 3016, 3020 C.O.E. and 1500	O O	83122	89406	
	9000 Models	O O	83122	89406	
	Brigadier Models	22012065 22046483 22052336	O O	85304
			O O	85304
			O O	85304
	Models with Hendrickson HN - 400 Rear suspension	3971703		O -	83112	...
78 - 83	RC2	O O	83122	89406
	Road Boss, Road Boss II, Road Commander II, Road Expeditor - (Four Shocks per Axle)	3946210	- -	83103
	Road Boss, Road Boss II, Road Commander, Road Commander II, Road Expeditor II - (Four Shocks per Axle)	02-7005976 02-7005977 4975479 4975480	- -	83400
			- -	83400
			- -	83400
			- -	83400
	Models with Hendrickson Airtek	20469001 20469002 471700131920 471700131921	O O	85933	89454	
			O O	85933	89454	
			O O	85933	89454	
			O O	85933	89454	

APPLICATION GUIDE - TRUCKS, TRAILERS, AND BUSES

Year Año Année	Model Modelo Modèle	OEM #	Front		Rear	
						
			Fleetline	GasSLX	Fleetline	GasSLX

VOLVO(Cont'd.)





Additional Applications(Cont'd.)

Models with Hendrickson Airtex	64838-001	010	85933	89454
	64838-002	010	85933	89454

Additional O.E.M. Interchanges

Additional O.E.M. Interchanges	OEM #	Code	Interchange
	03-1106460	010	85005 or 89430
	20863239	01-	85080
	35901-0003	010	85301
	35901-0004	010	83219
	35901-0011	010	83123 or 89405
	35901-0017	010	83314
	35901-0022	01-	83635
	35901-3406	010	85305
	35901-3409	010	85304
	35901-3410	010	85307
	35901-3413	010	85006
	35901-3420	010	85303 or 89422
	37001-5	010	83401
	37301-0001	010	85013 or 89414
	37301-0018	010	85005 or 89430
	3953643	010	85040
	4940640	010	83216
	494-660	010	83219
	5322338	010	83214
	5513989	010	83216
	5531435	010	85307
	5531436	010	85307
	5531437	010	85307
	5534430	010	85303 or 89422
	5534447	010	85303 or 89422
	5549899	010	83207 or 89407
	5549925	010	85304
	629398	010	85307
	629501	010	85307
	646220	010	85734
	66010-0016	01-	85025
	668302	010	83216
	6771501	010	85040
	6775411	010	85040
	1091347	010	83125
	1091348	010	83122 or 89406
	1091349	010	83204
	1091350	010	83207 or 89407
	1091351	010	83209 or 89414
	1091353	010	83215
	1091354	010	83216
	1091355	010	83217
	1091357	010	83219
	1091358	-1-	83456 or 89447
	1091359	010	83123 or 89405
	1091360	010	83303
	1091361	010	83304
	1091362	010	83309 or 89446

APPLICATION GUIDE - TRUCKS, TRAILERS, AND BUSES





Year Año Année	Model Modelo Modèle	OEM #	Front		Rear	
						
			Fleetline	GasSLX	Fleetline	GasSLX

VOLVO(Cont'd.)

Additional O.E.M. Interchanges(Cont'd.)

Additional O.E.M. Interchanges		
	1091363	010 83221
	1091364	010 83312 or 89409
	1091365	-1- 83400
	1091366	010 83401
	1091367	010 85000 or 89436
	1091368	010 85003 or 89411
	1091370	010 85006
	1091371	010 85300 or 89419
	1091372	010 85301
	1091373	010 85302 or 89420
	1091374	010 85303 or 89422
	1091375	010 85304
	1091376	010 85305
	1091377	010 85307
	1091378	010 85308 or 89422
	1091379	-1- 85310 or 89423
	1091384	010 85735
	1093100	-1- 85027 or 89418
	1093174	01- 83353
	1093176	010 85024 or 89416
	1093177	01- 85025
	1093178	01- 85026 or 89417
	1093180	010 85030 or 89440
	1716824	010 85304
	19501669	010 85339
	19502711	010 85702
	19506846	010 85339
	3130140	010 85315
	3171696	010 85307
	3172948	010 85303 or 89422
	3199937	-10 85316 or 89426
	3199938	010 85030 or 89432
	3199939	010 85058 or 89431
	3199940	010 85005 or 89430
	3199941	010 85006
	3199942	010 89402
	3199943	010 85012 or 89413
	3199944	010 85006
	3199945	-1- 85027 or 89418
	3199946	-10 85033 or 89427
	3199947	010 85013 or 89414
	3199948	-10 85311 or 89424
	3199949	-1- 85310 or 89423
	3199950	010 85023 or 89415
	3199951	010 85024 or 89416
	3199952	010 85736
	3199953	-10 85319 or 89428
	3199954	010 85003 or 89411
	3199955	010 85300 or 89419
	3199956	010 85036 or 89405
	3199957	010 83122 or 89406

APPLICATION GUIDE - TRUCKS, TRAILERS, AND BUSES





Year Año Année	Model Modelo Modèle	OEM #	Front		Rear	
						
			Fleetline	GasSLX	Fleetline	GasSLX

VOLVO(Cont'd.)

Additional O.E.M. Interchanges(Cont'd.)

Additional O.E.M. Interchanges	OEM #	Interchange Code	Interchange Part
	3199959	010	85323 or 89436
	3199960	010	85322
	3199961	010	85307
	3199962	010	85314 or 89425
	3199963	010	85315
	3199965	010	85736
	3199966	010	85303 or 89422
	3199967	010	85302 or 89420
	3199968	010	85308 or 89422
	3199970	-1-	85701
	3199972	010	85320 or 89429
	3199973	-1-	85722
	3199974	010	85712
	3199975	010	85700
	3199976	-10	85711
	3199977	-10	85711
	3199978	010	85712
	3199979	010	85702
	3199980	-1-	85310 or 89423
	3199982	-10	85703
	3199983	010	85704
	3199984	010	85314 or 89425
	3199985	01-	85723
	3199986	-1-	85318
	3199987	-1-	85705
	3199988	-10	85311 or 89424
	3199989	-1-	85709
	3199990	010	85003 or 89411
	3199991	-1-	85708
	3199992	01-	85733
	3199993	010	85712
	3199994	010	85308 or 89422
	3915917	-10	85319 or 89428
	3915947	010	85001 or 89410
	3915948	-10	85311 or 89424
	3916352	010	85013 or 89414
	3919055	010	85007 or 89412
	3919056	010	83203 or 89436
	3919057	010	83225
	3919526	010	83314
	3919561	010	85314 or 89425
	3919565	-1-	83103
	3919567	-1-	83613
	3919568	010	83636
	3919569	010	85052
	3919570	010	83128
	3919571	01-	83635
	3919572	010	83130
	3919573	010	83123 or 89405
	3919574	010	85006 or 89401
	3919575	01-	83120

APPLICATION GUIDE - TRUCKS, TRAILERS, AND BUSES





Year Año Année	Model Modelo Modèle	OEM #	Front		Rear	
						
			Fleetline	GasSLX	Fleetline	GasSLX

VOLVO(Cont'd.)

Additional O.E.M. Interchanges(Cont'd.)

Additional O.E.M. Interchanges			
	3919582	010	83215
	3919583	010	83100
	3919584	01-	83353
	3919585	010	83209 or 89414
	3919586	010	83100
	3919587	-10	83105
	3919588	010	83216
	3919589	01-	85026 or 89417
	3919590	010	85042
	3919591	-10	83515
	3919592	010	85024 or 89416
	3919593	010	83242
	3919594	010	85003 or 89411
	3919596	01-	G63484
	3919598	010	83312 or 89409
	3919900	010	85012 or 89413
	3919901	-1-	83103
	3919902	010	83126 or 89430
	3919903	010	83216
	3919904	010	G63183
	3919906	010	83308
	3919907	010	83309 or 89446
	3919908	010	83104
	3919909	010	G63605
	3919910	010	83221
	3919911	010	83124 or 89407
	3919912	010	83215
	3919913	010	83203 or 89436
	3919914	010	83209 or 89414
	3919915	010	83127
	3919916	010	83126 or 89430
	3919917	010	83125
	3919918	010	83401
	3919919	010	G63625
	3919920	010	83303
	3919921	010	83123 or 89405
	3919922	-1-	83318
	3919923	-10	83301
	3919924	-1-	83456 or 89447
	3919925	-10	83317
	3919926	010	G63403
	3919927	010	83101
	3919928	010	83225
	3919930	01-	83353
	3919931	010	83126 or 89430
	3919932	010	85062 or 89408
	3919933	010	85001 or 89410
	3919934	010	85320 or 89429
	3919935	01-	85026 or 89417
	3919936	010	83207 or 89407
	3919937	-10	85316 or 89426

APPLICATION GUIDE - TRUCKS, TRAILERS, AND BUSES





Year Año Année	Model Modelo Modèle	OEM #	Front		Rear	
						
			Fleetline	GasSLX	Fleetline	GasSLX

VOLVO(Cont'd.)

Additional O.E.M. Interchanges(Cont'd.)

Additional O.E.M. Interchanges	OEM #	Code	Interchange
	3919938	010	85030 or 89432
	3919939	010	85058 or 89431
	3919940	010	85005 or 89430
	3919941	010	85006
	3919942	010	89402
	3919943	010	85012 or 89413
	3919944	010	85036
	3919945	-1-	85027 or 89418
	3919946	-10	85033 or 89427
	3919947	010	85013 or 89414
	3919948	-10	85311 or 89424
	3919949	-1-	85310 or 89423
	3919950	010	83219
	3919951	010	83309 or 89416
	3919952	010	85736
	3919953	-10	85319 or 89428
	3919954	010	85003 or 89411
	3919955	010	85300 or 89419
	3919956	010	85036 or 89405
	3919957	010	83122 or 89406
	3919959	010	85000 or 89436
	3919960	010	85322
	3919961	010	85302 or 89420
	3919962	010	85700
	3919963	010	85730
	3919964	010	85304
	3919965	010	85702
	3919966	010	85736
	3919967	010	85302 or 89420
	3919968	010	85736
	3919970	-1-	85701
	3919972	010	85320 or 89429
	3919973	010	85956
	3919974	010	85712
	3919975	010	85700
	3919976	-10	85033 or 89427
	3919977	-10	85033 or 89427
	3919978	010	85702
	3919979	010	85702
	3919980	010	85702
	3919981	-1-	85701
	3919982	-10	85703
	3919983	010	85704
	3919984	010	85700
	3919985	01-	85723
	3919987	-1-	85706
	3919988	-10	85311 or 89424
	3919989	-1-	85709
	3919990	010	85003 or 89411
	3919991	-1-	85708
	3919992	01-	85733

APPLICATION GUIDE - TRUCKS, TRAILERS, AND BUSES





Year Año Année	Model Modelo Modèle	OEM #	Front		Rear	
						
			Fleetline	GasSLX	Fleetline	GasSLX

VOLVO(Cont'd.)

Additional O.E.M. Interchanges(Cont'd.)

Additional O.E.M. Interchanges			
	3919993	0 0	85712
	3919994	- -	85310 or 89423
	3945806	0 -	89417
	3945807	0 0	89416
	3945808	0 0	89407
	3945809	0 0	89410
	3945810	0 0	89420
	3945811	0 0	89409
	3945812	- -	89423
	3945813	- 0	89428
	3945814	- 0	89424
	3945815	0 0	89406
	3945816	0 0	89430
	3945817	0 0	89422
	3945818	0 0	89415
	3945819	0 0	89411
	3945820	0 0	89413
	3945821	0 0	89419
	3946217	0 0	83125
	3946219	- -	83400
	662211401	0 0	83215
	83176191	0 -	83019
	83176192	0 -	83041
	83176193	0 -	83045
	83176194	0 0	83048
	83176195	- -	83103
	83176196	0 -	83110
	83176197	0 -	83111
	83176198	0 -	83112
	83176199	0 0	83123
	83176200	0 0	83124
	83176201	0 0	83125
	83176202	0 0	83126
	83176203	0 0	83127
	83176204	0 0	83128
	83176205	- -	83136
	83176206	0 0	83148
	83176207	0 0	83203
	83176208	0 0	83209
	83176209	0 0	83215
	83176210	0 0	83216
	83176211	0 0	85000
	83176212	0 0	85001
	83176213	0 0	85003
	83176214	0 0	85005
	83176215	0 0	85023
	83176216	0 -	85026
	83176217	- 0	85033
	83176218	0 0	85036
	83176219	0 0	85045
	83176220	0 0	85046

APPLICATION GUIDE - TRUCKS, TRAILERS, AND BUSES





Year Año Année	Model Modelo Modèle	OEM #	Front		Rear	
						
			Fleetline	GasSLX	Fleetline	GasSLX

VOLVO(Cont'd.)

Additional O.E.M. Interchanges(Cont'd.)

Additional O.E.M. Interchanges			
	83176221	010	85047
	83176222	010	85052
	83176223	010	85061
	83176224	010	85062
	83176225	010	85066
	83176226	010	85067
	83176227	- -	85069
	83176228	010	85070
	83176229	010	85303
	83176230	- -	85310
	83176231	- 0	85311
	83176232	010	85320
	83176233	010	85321
	83176234	010	85323
	83176235	010	85724
	83176236	- -	85900
	83176237	010	85916
	83176238	010	85918
	83176239	010	85933
	83176240	010	646155
	85104186	010	85006
	85106580	010	85918 or 89449
	85137234	010	83125
	85137420	010	85000 or 89436
	RC SA3041	01-	83041
	RC SA3045	01-	83045
	RC SA3048	010	83048
	RC SA3103	- -	83103
	RC SA3111	01-	83111
	RC SA3112	01-	83112
	RC SA3124	010	83124
	RC SA3125	010	83125
	RC SA3127	010	83127
	RC SA3128	010	83128 or 89436
	RC SA3136	- -	83136
	RC SA3148	010	83148
	RC SA3203	010	83203
	RC SA3216	010	83216
	RC SA5000	010	85000
	RC SA5001	010	85001
	RC SA5003	010	85003
	RC SA5005	010	85005
	RC SA5047	010	85047
	RC SA5052	010	85052
	RC SA5061	010	85061
	RC SA5062	010	85062
	RC SA5066	010	85066
	RC SA5067	010	85067
	RC SA5070	010	85070
	RC SA5310	- -	85310
	RC SA5320	010	85320

APPLICATION GUIDE - TRUCKS, TRAILERS, AND BUSES





Year Año Année	Model Modelo Modèle	OEM #	Front		Rear	
						
			Fleetline	GasSLX	Fleetline	GasSLX

VOLVO(Cont'd.)

Additional O.E.M. Interchanges(Cont'd.)

Additional O.E.M. Interchanges	OEM #		
	RC SA5724	010	85724
	RC SA5900	-1-	85900
	RC SA5918	010	85918
	RC SA5933	010	85933
	RC SA6155	010	646155
	SA3019	01-	83019
	SA3041	01-	83041
	SA3045	01-	83045
	SA3048	010	83048
	SA3103	-1-	83103
	SA3110	01-	83110
	SA3111	01-	83111
	SA3112	01-	83112
	SA3123	010	83123
	SA3124	010	83124
	SA3125	010	83125
	SA3126	010	83126
	SA3127	010	83127
	SA3128	010	83128
	SA3136	-1-	83136
	SA3148	010	83148
	SA5000	010	85000
	SA5001	010	85001
	SA5003	010	85003
	SA5005	010	85005
	SA5023	010	85023
	SA5026	01-	85026
	SA5033	-10	85033
	SA5036	010	85036
	SA5045	010	85045
	SA5046	010	85046
	SA5047	010	85047
	SA5052	010	85052
	SA5061	010	85061
	SA5062	010	85062
	SA5066	010	85066
	SA5067	010	85067
	SA5069	-1-	85069
	SA5070	010	85070
	SA5303	010	85303
	SA5310	-1-	85310
	SA5311	-10	85311
	SA5320	010	85320
	SA5321	010	85321
	SA5323	010	85323
	SA5724	010	85724
	SA5900	-1-	85900
	SA5916	010	85916
	SA5918	010	85918
	SA5933	010	85933
	SA6155	010	646155

APPLICATION GUIDE - TRUCKS, TRAILERS, AND BUSES

Year Año Année	Model Modelo Modèle	OEM #	Front		Rear	
						
			Fleetline	GasSLX	Fleetline	GasSLX

VOLVO(Cont'd.)

Additional O.E.M. Interchanges(Cont'd.)

Models with O.E.M. Number	OEM #		85061	89450	
	14170000373	010	85061	89450	
	3092842	010	85061	89450	
	35901-0001		010	83209	89414
	35901-0008		010	85060	...
	37301-0008	-1-	83400
	3919958		010	85046	89434
	3946239		010	85724	89443
	3949240		010	85047	89435
	3949241	010	85061	89450	
	3972662		010	85976	...
	665410	-1-	85027	89418	
	665539	01-	85026	89417	
	665739		010	85047	89435
	70042	010	85302	89420	
	8075287		01-	85065	...
	8174749		010	85906	89407
	85104221		010	85066	89448
	85107238		010	85976	...
	85134402	010	85061	89450	

VOLVO CAB SHOCKS

Aero Models (WCA & WIA Models)	66010-0007	010	83004
	66010-0008	010	83004
	8162662	010	83004
Link Cabmate Model WRC-2P	1202-0032	010	83016
Models with Link Cab Suspension	1202-0022	010	83046
Models with O.E.M. Number	20874147	01-	83050
	3945842	010	83009
	635869	010	83004
	8168617	010	83030
	85107095	010	83009
2014 - VAH 430 Models with 42" Sleeper Cabs	20721254	010	83048
	22662224	010	83048
06 - 10 VT Models - All with 60" to 77" Mid - High Roof Sleepers (w/O.E.M. Number)	20721254	010	83048
WG Conventional Tractors with 112" cabs with Link Cabmate Model WWG112-A	1201-0012	010	83023
	1202-0012	010	83023





VHD - Series

12 - 17 VHD 64T-200 Models - With O.E.M. Number	22662230	010	TBR - 83905
08 - 09 VHD Models - With O.E.M. Number	20704334	010	83048
	22662125	010	83048

VN Series - 2200

VN Models - Horizontal Position	20496217	010	83029
	8078547	010	83029
VN Models - Vertical Position (w/O.E.M. Number)	20496215	010	83048
	20704334	010	83048
	20721254	010	83048
	21368413	010	83048
	22662125	010	83048
	8078546	010	83028

APPLICATION GUIDE - TRUCKS, TRAILERS, AND BUSES

Year Año Année	Model Modelo Modèle	OEM #	Front		Rear	
						
			Fleetline	GasSLX	Fleetline	GasSLX

VOLVO CAB SHOCKS(Cont'd.)

VNL - Series(Cont'd.)

06 - 10	VNL 42T-300 Models - With O.E.M. Number	20704334	010	83048
		22662125	010	83048
11 -	VNL 42T-300 Models - With O.E.M. Number	22662230	010	TBR - 83905
13 - 16	VNL 64T-630 Models with Flat Top Sleepers	21391412	010	83048
- 13	VNL 64T-670 Models with High Rise Sleeper Cabs	21368413	010	83048
14 - 17	VNL 64T-670 Models with High Rise Sleeper Cabs	22662235	010	TBR - 83905
2017	VNL 64T-730 Models with Mid Rise Sleeper Cabs	22662237	010	TBR - 83905
- 14	VNL 64T-780 Models with High Rise Sleeper Cabs	20721254	010	83048
		21368413	010	83048
15 - 17	VNL 64T-780 Models with High Rise Sleeper Cabs	22662237	010	TBR - 83905
13 - 16	VNL Models - 64T-430 with Flat Top Sleepers	21391412	010	83048
06 - 11	VNL Models - All with 60" to 77" Mid - High Roof Sleepers (w/O.E.M. Number)	20721254	010	83048





VNM - Series

2013	VNM 42T-200 Day Cab Models	21368411	010	TBR - 83905
13 - 17	VNM 64T-200 Day Cab Models	21368411	010	TBR - 83905
		22662230	010	TBR - 83905
		22662237	010	TBR - 83905
2016	VNM 64T-630 Models with High Rise Sleeper Cabs	22662235	010	TBR - 83905
- 14	VNM Models - All with 60" to 77" Mid - High Roof Sleepers (w/O.E.M. Number)	21391412	010	83048

WABASH NATIONAL

Identification of the trailer suspension is necessary to determine what section of the catalog to refer to. Some possible options can be Chalmers, Hendrickson, Neway, Ridewell, Reyco.							
97 -	RHP11, RHP55 and RideSentry Trailer Suspension	202447	010	85919	...
		203447	010	85919	...
	Trailers with Aurora part number	DANSR1VJ100	010	85078	...
		FLL83203-071	010	83203	89436
		FLL83207-071	010	83207	89407
		FLL85000-071	010	85000	89436
		FLL85030-071	010	85030	89440
		FRUJCE1295-1	010	85300	89419
		FRUJCE1295-901	010	85300	89419
		FRUJCE2983-1	010	85322	...
		FRUUCF8339-1	010	85321	...
		HENS-20001	010	83128	89436
		HENS-20002	010	85000	89436
		HENS-20126	010	85323	89436
		HENS-21292	010	85052	...
		HENS-23566	010	85000	89436
		NEW900-44-089	010	83124	89407
		NEW900-44-162	010	83128	89436
		NEW900-44-625	010	83125	...
		NEW900-44-626	010	83126	89430
		NEW900-44-642	010	83127	...
		NEW900-44-794	010	83127	...
		NEW900-44-868	010	85045	...
		NEW900-44-978	010	85059	...
		NEW900-44-979	010	83113	...
NEW900-45-040	010	83130	...		
NEW900-45-054	010	85051	...		

APPLICATION GUIDE - TRUCKS, TRAILERS, AND BUSES

Year Año Année	Model Modelo Modèle	OEM #	Front		Rear	
						
			Fleetline	GasSLX	Fleetline	GasSLX

WABASH NATIONAL(Cont'd.)

	Trailers with Aurora part number	NEW900-45-298	010	83128	...
		NEW900-45-299	010	85000	89436
	Trailers with Aurora part number Heavy Duty Standard	HENS-24088	010	85000	89436
		HENS-24088	010	83128	89436

WATSON & CHALIN MFG. INC.

Heavy Duty Trailer Air Suspension

	TA-2590-14, 17 HD	10148	010	83204	...
	TA-3090-14, -17, -19	10148	010	83204	...
	TA-550-17	10148	010	83204	...

Light Weight Trailer Air Suspension

	TA-3175-9	17079	010	85300	89419
	TA-751-16	10148	010	83204	...

LWSL-1100-SR Self Steer Axle Suspension

	AL-1100-SR Models	10148	010	83204	...
	HL-1100-20	10148	010	83204	...
	HL-1100-20 FL	10147	010	83203	89436
	SL-1100-LR	12128	010	85005	89430

Trailer Air Suspension

	TA-2590-12, 14, 15, & 17,	12128	010	85005	89430
	TA-2590-12-1	10147	010	83203	89436

WCAL-2200 Series Pusher or Tag Axle Assembly

	AL-2200 Models	10148	010	83204	...
--	----------------	-------	-----	-----	-----	-------	-----

WCTA Series Dump Trailer Air Suspension

	TA-1600-21	11604	010	83125	...
	TA-1900-15	10147	010	83203	89436
	TA-1900-16, -17	10148	010	83204	...
	TA-1900-18, -19	12128	010	85005	89430
	TA-5000-DB-19, -F-19	12128	010	85005	89430
	TA-5000-DB-24, -DB-30, -F-24, -F-30,	11724	010	83123	89405
	TA-525, -DB	10147	010	83203	89436

WCTA Series Trailer Air Suspension

	TA-2075-6	10148	010	83204	...
	TA-2075-9	12128	010	85005	89430
	TA-250-12	10148	010	83204	...
	TA-250-6, 7.5, 9,	10147	010	83203	89436
	TA-251-12, -12FS,	10148	010	83204	...
	TA-251-6.5, -6.5FS,	10147	010	83203	89436
	TA-251-7.5, -7.5FS	10147	010	83203	89436
	TA-251-8FS	10147	010	83203	89436
	TA-251-9.0, -9.0FS, -10,	10147	010	83203	89436
	TA-255-9	10147	010	83203	89436
	TA-280-6.5, 7.5, -9.0,	11604	010	83125	...
	TA-300-9	10147	010	83203	89436
	TA-380-9	12128	010	85005	89430





WCTA-1200 Series Trailer Air Suspension

	TA-1000	10634	010	G63357	...
	TA-1200-5	10147	010	83203	89436

WCTL-2200 Series Trailer Air Lift

	TL-1600-21	11604	010	83125	...
--	------------	-------	-----	-----	-----	-------	-----

APPLICATION GUIDE - TRUCKS, TRAILERS, AND BUSES

Year Año Année	Model Modelo Modèle	OEM #	Front		Rear	
						
			Fleetline	GasSLX	Fleetline	GasSLX

WATSON & CHALIN MFG. INC.(Cont'd.)

WCTL-2200 Series Trailer Air Lift(Cont'd.)

10/89 -	TL-2590-12,14,15, & 17	12128		0 0	85005	89430
---------	------------------------	-------	--	-----	-----	-----	-------	-------

WCWB Series Trailer Air Suspension

	WB-2500-6	10148		0 0	83204	...
	WB-2500-7.5, -9,	12128		0 0	85005	89430
	WB-251-6.5, 7.5, 9	10147		0 0	83203	89436
	WB-280-9	11604		0 0	83125	...
	Models with O.E.M. Number	17300		0 0	85052	...
		3946219		- -	83400	...
		665727		0 0	85005	89430
		665769		0 0	85052	...

Additional O.E.M. Interchanges

	Models with O.E.M. Number	10147HD		0 0	85000	89436
		17186		0 0	85323	89436
		17186-01		0 0	85323	89436
		17218		0 0	85029	...
		17297		0 0	85064	...
		17306		0 0	85938	...
		17317		0 0	85344	...
		17382		0 0	85014	...
		17430		0 0	85321	...
		17474		- 0	85009	...
		19036		0 0	85934	...
		19249		0 0	85939	...
		19250		0 0	85382	...
		19603		0 0	85939	...
		665724		0 0	85000	89436
		665728		0 0	85060	...
		665770		0 0	85064	...
		665862		0 0	85000	89436
		680547		0 0	85323	89436
		680584		0 0	85938	...
		680714		0 0	85934	...
		727603		0 0	83203	89436
		727604		0 0	83204	...
		A-20345		0 0	85345	...
		B-23649		0 0	85064	...
		B-23650		0 0	85052	...
	B-23651		0 0	85045	...	
	B-23743		0 0	85938	...	





WESTERN STAR

	Models with Neway ADZ Rear Suspension	471700004423		0 0	85109	...
		90045605		0 0	85109	...

3800 Series - Heritage Class

	3842S, 3864S Models	37390-4401	0 0	85053	89442	
		37390-4402	0 0	85053	89442	
		37390-4403	0 0	85053	89442	
	With Hendrickson Rear Suspension	47902-13		0 0	83122	89406
		47902-24		0 0	83137	...
		47902-8		0 0	83122	89406
	With Neway Rear Suspension	90044025		0 0	83209	89414

APPLICATION GUIDE - TRUCKS, TRAILERS, AND BUSES

Year Año Année	Model Modelo Modèle	OEM #	Front		Rear	
						
			Fleetline	GasSLX	Fleetline	GasSLX

WESTERN STAR(Cont'd.)

3800 Series - Heritage Class(Cont'd.)

	With Neway Rear Suspension	90044907		0 -	83635	...
--	----------------------------	----------	--	-----	-----	-----	-------	-----

4700 Series

11 - 15	Models with 20000 lb Set -Back Front Axle	10-13809-000	0 0	85958
11 - 15	Models with FAS II Rear Air Suspension	16-18708-000		0 0	85724	89443





4800 & 4900 Series - Constellation Class

	4842FX, 4864FX, 4964EX, 4964EX, 4942SX or 4964SX Constellation Class	37301-3401	0 0	85053	89442	
			0 0	85053	89442	
			0 0	85053	89442	
			0 0	85053	89442	
			0 0	85053	89442	
			0 0	85053	89442	
			0 0	85053	89442	
09 - 12	Models w/ Low Profile Rear Air Suspension	16-18706-000		0 0	85331	...
09 - 15	Models with 12000 lb Taperleaf Front Suspension	10-13809-000 SDA471700003920	0 0	85958
			0 0	85958
08 - 15	Models with Freightliner TufTrac Rear Air Suspension	16-15770-000 SDA481700125969		0 0	85956	...
				0 0	85956	...
- 16	Models with Hendrickson Front Airtek	471700006269 471700131331 58913-003 58913-012	0 0	85932	89453	
			0 0	85932	89453	
			0 0	85932	89453	
			0 0	85932	89453	
	With Hendrickson HAS-40LH Rear Suspension	57241-1		0 -	83111	...
	With Hendrickson Rear Suspension	47902-13 47902-24 47902-8		0 0	83122	89406
				0 0	83137	...
				0 0	83122	89406
	With Neway Rear Suspension	90044025 90044907 90045099		0 0	83209	89414
				0 -	83635	...
				0 0	85906	89407

4800 & 4900 Series - Heritage Class

	4842F, 4864F, 4843S, 4864S, 4942F, 4964F, 4942S or 4964S Heritage Class	37301-3401	0 0	85053	89442	
			0 0	85053	89442	
			0 0	85053	89442	
			0 0	85053	89442	
			0 0	85053	89442	
			0 0	85053	89442	
			0 0	85053	89442	
09 - 15	Models with 12000 lb Taperleaf Front Suspension	10-13809-000 SDA471700003920	0 0	85958
08 - 15	Models with Freightliner TufTrac Rear Air Suspension	16-15770-000 SDA481700125969		0 0	85956	...
				0 0	85956	...
- 16	Models with Hendrickson Front Airtek	471700006269 471700131331 58913-003 58913-012	0 0	85932	89453	
			0 0	85932	89453	
			0 0	85932	89453	
			0 0	85932	89453	
	With Hendrickson HAS-40LH Rear Suspension	57241-1		0 -	83111	...
	With Hendrickson Rear Suspension	47902-13 47902-24 47902-8		0 0	83122	89406
				0 0	83137	...
				0 0	83122	89406
	With Neway Rear Suspension	90044025		0 0	83209	89414

APPLICATION GUIDE - TRUCKS, TRAILERS, AND BUSES

Year Año Année	Model Modelo Modèle	OEM #	Front		Rear	
						
			Fleetline	GasSLX	Fleetline	GasSLX

WESTERN STAR(Cont'd.)

4800 & 4900 Series - Heritage Class(Cont'd.)

	With Neway Rear Suspension	90044907 90045099	01-	83635	...
			010	85906	89407









5800 & 5900 Series - Constellation Class

	5842SS, 5864SS, 5942SS or 5964SS Constellation Class	37301-3401 37301-3404 37301-3409 37301-3412 37390-4401 37390-4402 37390-4403	010	85053	89442	
			010	85053	89442	
			010	85053	89442	
			010	85053	89442	
			010	85053	89442	
			010	85053	89442	
			010	85053	89442	
09 - 15	Models with 12000 lb Taperleaf Front Suspension	10-13809-000 SDA471700003920	010	85958
			010	85958
08 - 15	Models with Freightliner TufTrac Rear Air Suspension	16-15770-000 SDA481700125969		010	85956	...
				010	85956	...
	With Hendrickson Rear Suspension	47902-13 47902-24 47902-8		010	83122	89406
				010	83137	...
				010	83122	89406
	With Neway Rear Suspension	90044025 90044907 90045099		010	83209	89414
				01-	83635	...
				010	85906	89407
	With Hendrickson Rear Suspension	57905-2		010	85006	...

5900 & 6900 Series - Heritage Class

	5942S, 5964S, 6964F or 6964S Heritage Class	37301-3401 37301-3404 37301-3409 37301-3412 37390-4401 37390-4402 37390-4403	010	85053	89442	
			010	85053	89442	
			010	85053	89442	
			010	85053	89442	
			010	85053	89442	
			010	85053	89442	
			010	85053	89442	
	All with 4 shock Front System	010	83401
09 - 15	Models with 12000 lb Taperleaf Front Suspension	10-13809-000 SDA471700003920	010	85958
			010	85958
08 - 15	Models with Freightliner TufTrac Rear Air Suspension	16-15770-000 SDA481700125969		010	85956	...
				010	85956	...
- 06/10	Models with Hendrickson Airtek Suspension	58913-003	010	85932	89453	
07/10 -	Models with Hendrickson Airtek Suspension	471700006269 58913-012	010	85932	89453	
			010	85932	89453	
	With Hendrickson HAS-40LH Rear Suspension	57241-1		01-	83111	...
	With Hendrickson Rear Suspension	47902-13 47902-24 47902-8 60675-002		010	83122	89406
				010	83137	...
				010	83122	89406
				010	85979	...
	With Neway Rear Suspension	90044025 90044907 90045099		010	83209	89414
				01-	83635	...
				010	85906	89407
	Models with O.E.M. Number	02-7005976 02-7005977 04-9041375 28R010 35066-4413 35901-0001	1-	83400
			1-	83400
				010	85315	...
			010	83216
				010	83122	89406
				010	83209	89414

APPLICATION GUIDE - TRUCKS, TRAILERS, AND BUSES

Year Año Année	Model Modelo Modèle	OEM #	Front		Rear	
						
						
			Fleetline	GasSLX	Fleetline	GasSLX

WESTERN STAR(Cont'd.)

5900 & 6900 Series - Heritage Class(Cont'd.)

	Models with O.E.M. Number	35901-4403		OIO	85060	...
		37301-3405	OIO	85053	89442	
		57252	OIO	85308	89422	
		57905-1		OIO	85976	...
		665682	OIO	85053	89442	
		CP-5222		OIO	85315	...
	With Hendrickson Rear Suspension	57905-2		OIO	85006	...
	Additional O.E.M. Interchanges	1011839	OIO	83216
		35901-3406	OIO			85305		
		35901-3409	OIO			85304		
		35901-3410	OIO			85307		
		35901-3413	OIO			85006		
		35901-3420	OIO			85303 or 89422		
		615016	OIO			83401		
		676081	OIO			83401		
		676082	OIO			83401		









WESTERN STAR CAB SHOCKS

	6900 Models	725470	OIO			83010	
01 - 15	6900 SX Models	66010-3407	OIO			83065	
	Constellation Day Cab Models	18-60772-000	OIO			83026	
		66010-3405	OIO			83026	
		81-4903003500	OIO			83026	
	Constellation Sleeper Cab Models	18-60773-000	OIO			83027	
		66010-3406	OIO			83027	
		814903003501	OIO			83027	
86 -	Conventional Tractors with Link Cabmate Model WSC4000	1201-0012	OIO			83023	
		1202-0012	OIO			83023	
	For 4800, 4900, 6900 Heritage & Constellation Day Cab	66010-3402	OIO			83022	
		66010-3403	OIO			83022	
	Heritage Constellation models	66010-3404	OIO			83022	
	Models with Link Cab Suspension	1201-0022	OIO			83046	
		1202-0022	OIO			83046	
		1202-0032	OIO			83016	
	Models with O.E.M. Number	617547	OIO			83022	
		654846	OIO			83027	
		GBL 654916	OIO			83026	

WESTERN UNIT "STABILAIRE" SUSPENSION

	Model 893T Trailer Suspension	OIO	85307	...
	Model TDA202, 203, 206, 240, 241, 243 Truck Drive Axle Suspension	OIO	85735	...
	Model TDA204, 205, 242 - Truck Drive Axle Suspension	OIO	85307	...
	Models with O.E.M. Number	101030		OIO	85307	...
		101364		OIO	85305	...
		4939967		OIO	85308	89422
		80370		OIO	85304	...
		80600		OIO	85300	89419

APPLICATION GUIDE - TRUCKS, TRAILERS, AND BUSES

Year Año Année	Model Modelo Modèle	OEM #	Front		Rear	
						
						
			Fleetline	GasSLX	Fleetline	GasSLX

WINNEBAGO

Class A MotorHomes

03 - 06	Journey Series MotorHomes with Freightliner XC Chassis ADL200 Suspension w/ 20K Rear AS120 Front Suspension Rear Shock with O.E.M. Number ZF - IFS Front Suspension with 23,000 lb GVW or Greater	16-16873-000 141700131810 16-16737-000 16-16874-000 141700131809 16-16736-000 16-18103-000 481700000493						
					OIO	85029		
			OIO	83160				
			OIO	83160				
			OIO	83160				
					OIO	85029		
					OIO	85029		
			-I-	85900				
			-I-	85900				
			06	Tour Series MotorHomes with Freightliner XC Chassis ADL200 Suspension w/ 20K Rear AS120 Front Suspension Rear Shock with O.E.M. Number ZF - IFS Front Suspension with 23,000 lb GVW or Greater	16-16873-000 141700131810 16-16737-000 16-16874-000 141700131809 16-16736-000 16-18103-000 481700000493			
		OIO				85029		
OIO	83160							
OIO	83160							
OIO	83160							
		OIO				85029		
		OIO				85029		
-I-	85900							
-I-	85900							
04 - 06	Vetra Series MotorHomes with Freightliner XC Chassis ADL200 Suspension w/ 20K Rear AS120 Front Suspension Rear Shock with O.E.M. Number ZF - IFS Front Suspension with 23,000 lb GVW or Greater	16-16873-000 141700131810 16-16737-000 16-16874-000 141700131809 16-16736-000 16-18103-000 481700000493						
					OIO	85029		
			OIO	83160				
			OIO	83160				
			OIO	83160				
					OIO	85029		
					OIO	85029		
			-I-	85900				
			-I-	85900				

WORKHORSE

	Models with O.E.M. Number	659223 680672				
					OIO	G63866
	Models with RSAS Rear Suspension	7805-X-1012				
	Step Van Models with O.E.M. Number	659222	OIO	83171		
		W0007363	OIO	83171		
		W0007365			OIO	G63866
		W8007000	OIO	83171		
06 - 09	W16 & W18 MotorHome Chassis with O.E.M. Number	F4-BE5-F324-HO	OIO	85125		
		W0005662	OIO	85125		
05 - 14	W20 , W22, & W24 MotorHome Chassis with O.E.M. Number	24-153256			-I-	85124
		F4-BE5-F325-HO			-I-	85124
		W0005663			-I-	85124
98 - 04	W20 , W22, & W24 MotorHome Chassis with O.E.M. Number	24-186537			OIO	85126
		F4-BE5-A011-HO			OIO	85126
98 - 14	W20 , W22, & W24 MotorHome Chassis with O.E.M. Number	24-153249	OIO	85125		
		24-186629	OIO	85125		
		F4-BE5-A832-MO	OIO	85125		
		F4-BE5-B492-HO	OIO	85125		
		F4-BE5-F324-HO	OIO	85125		
		W0005662	OIO	85125		
		W0006254	OIO	85125		

NUMERICAL LISTING LISTA NUMÉRICA LISTE NUMÉRIQUE

GABRIEL#	APPLICATION	MTG ACC PKG NO	GABRIEL#	APPLICATION	MTG ACC PKG NO	GABRIEL#	APPLICATION	MTG ACC PKG NO
Shocks for Special Applications			G63403	W FREIGHTLINER VOLVO	Not Req'd.	G63775	W FORD	Not Req'd.
83176	N VARIOUS	Not Req'd.	G63405	W MITSUBISHI-FUSO	140884	G63778	W FORD	142700
632147	W CHALLENGE LINK/HIGH-STEER MC NEILUS TRUCK & MAN. WATSON & CHALIN MFG. INC.	Not Req'd.	G63406	W FORD	Not Req'd.	G63808	W FORD	Not Req'd.
646155	A ADVANCE MIXER GRANNING SUSPENSION HENDRICKSON TRAILER SUSPENSION SYSTEMS KIMBLE MIXER CO LINK/HIGH-STEER LONDON MIXER MC NEILUS TRUCK & MAN. REX MIXER RIDEWELL CORPORATION SAF HOLLAND SUSPENSIONS INC. TEREX CORPORATION TUTHILL TECHNOLOGIES WATSON & CHALIN MFG. INC.	Not Req'd.	G63409	W FORD	Not Req'd.	G63809	W FORD STERLING TRUCK	Not Req'd.
646177	C CHALLENGE LINK/HIGH-STEER OSHKOSH MOTORS PIERCE MANUFACTURING INC. SAF HOLLAND SPRING VALLEY WESTPORT AXLE CORP	Not Req'd.	G63414	W FORD	140780	G63810	W FORD	Not Req'd.
665472	W INGERSALL MACHINE	Not Req'd.	G63419	W HINO	Not Req'd.	G63811	W FORD	Not Req'd.
665937	W LINK/HIGH-STEER REYCO SUSPENSION RIDEWELL CORPORATION	Not Req'd.	G63432	W INTERNATIONAL (NAVISTAR) NISSAN	141349 & 140169	G63837	W FORD	Not Req'd.
Gas Light Truck Applications			G63440	W HINO	Not Req'd.	G63866	W MOR-RYDE SUSPENSION WORKHORSE	Not Req'd.
G63183	W CHRYSLER DODGE TRUCK FREIGHTLINER HOLIDAY RAMBLER JOHN DEERE MOR-RYDE SUSPENSION OSHKOSH MOTORS VOLVO	Not Req'd.	G63455	W FORD	Not Req'd.	G63929	W FORD	140780
G63299	W FORD INTERNATIONAL (NAVISTAR) MITSUBISHI-FUSO	140885(1)	G63461	W FORD	Not Req'd.	G63969	W FORD	143146
G63306	W FORD INTERNATIONAL (NAVISTAR)	Not Req'd.	G63484	W VOLVO	140524	Fleetline Applications		
G63347	W CHEVROLET TRUCK (Also See GMC Truck) GMC TRUCK	Not Req'd.	G63500	W FORD	140780	83001	B FREIGHTLINER CAB SHOCKS	404702(1)
G63350	W FORD	140126	G63511	W FORD	141353	83002	C KENWORTH CAB SHOCKS LINK MANUFACTURING CAB SHOCKS	Not Req'd.
G63355	W CHALMERS SUSPENSION	140702	G63524	W FORD	Not Req'd.	83003	W MACK CAB SHOCKS	140455(1)
G63357	W WATSON & CHALIN MFG. INC.	Not Req'd.	G63525	W FORD	Not Req'd.	83004	W VOLVO CAB SHOCKS	Not Req'd.
G63386	W FORD STERLING TRUCK	140780	G63605	W DODGE TRUCK FREIGHTLINER JOHN DEERE OSHKOSH MOTORS VOLVO	140169	83005	W INTERNATIONAL (NAVISTAR) CAB SHOCKS LINK MANUFACTURING CAB SHOCKS	140455(1)
G63387	W FORD STERLING TRUCK	140126	G63607	W FORD	140719	83006	W FREIGHTLINER CAB SHOCKS	404702(1)
G63396	W FORD	140780	G63608	W FORD	140780	83007	W MACK CAB SHOCKS	404702(2) & 140702(1)
G63398	W FORD MITSUBISHI-FUSO	141138	G63610	W HINO INTERNATIONAL (NAVISTAR) ISUZU MITSUBISHI-FUSO NISSAN	142389	83008	A KENWORTH PETERBILT CAB SHOCKS	Not Req'd.
			G63614	W FORD	140780	83009	A FREIGHTLINER CAB SHOCKS MC NEILUS TRUCK & MAN. OSHKOSH MOTORS CAB SHOCKS VOLVO CAB SHOCKS	Not Req'd.
			G63622	W FORD	142617	83010	W WESTERN STAR CAB SHOCKS	Not Req'd.
			G63623	W FORD	142617	83011	W KENWORTH CAB SHOCKS PETERBILT CAB SHOCKS	404702(2)
			G63624	W FORD	140780	83012	W KENWORTH CAB SHOCKS PETERBILT CAB SHOCKS	404702(2)
			G63625	W VOLVO	140702	83013	W INTERNATIONAL (NAVISTAR) CAB SHOCKS LINK MANUFACTURING CAB SHOCKS	Not Req'd.
			G63676	W FORD	Not Req'd.	83014	X INTERNATIONAL (NAVISTAR) CAB SHOCKS MACK CAB SHOCKS	140455(2)
			G63678	W FORD	Not Req'd.	83015	W INTERNATIONAL (NAVISTAR) CAB SHOCKS	140455(1)
			G63679	W FORD	140719	83016	W CHEVROLET TRUCK CAB SHOCKS FORD CAB SHOCKS FREIGHTLINER CAB SHOCKS GMC TRUCK CAB SHOCKS INTERNATIONAL (NAVISTAR) CAB SHOCKS KENWORTH CAB SHOCKS LINK MANUFACTURING CAB SHOCKS MACK CAB SHOCKS PETERBILT CAB SHOCKS VOLVO CAB SHOCKS WESTERN STAR CAB SHOCKS	Not Req'd.
			G63714	W FORD	142731			
			G63716	W FORD	142731			
			G63772	W FORD	141665			
			G63773	W FORD	Not Req'd.			

N = New, X = Discontinued once inventory is gone

NUMERICAL LISTING LISTA NUMÉRICA LISTE NUMÉRIQUE

GABRIEL#	APPLICATION	MTG ACC PKG NO	GABRIEL#	APPLICATION	MTG ACC PKG NO	GABRIEL#	APPLICATION	MTG ACC PKG NO
83017	W FREIGHTLINER CAB SHOCKS	Not Req'd.	83039	W FREIGHTLINER CAB SHOCKS	Not Req'd.	83065	N WESTERN STAR CAB SHOCKS	Not Req'd.
83018	W MACK CAB SHOCKS	140780(1)	83040	W FREIGHTLINER CAB SHOCKS	Not Req'd.	83066	N MACK CAB SHOCKS	Not Req'd.
83019	W MACK CAB SHOCKS VOLVO	140780(1)	83041	D MACK CAB SHOCKS VOLVO	140780(1)	83067	N KENWORTH CAB SHOCKS PETERBILT CAB SHOCKS	Not Req'd.
83020	W FREIGHTLINER CAB SHOCKS	Not Req'd.	83042	W KENWORTH CAB SHOCKS PETERBILT CAB SHOCKS	Not Req'd.	83100	W INTERNATIONAL (NAVISTAR) MERCEDES BENZ VOLVO	Not Req'd.
83021	C CHEVROLET TRUCK CAB SHOCKS CNH GLOBAL N V FREIGHTLINER CAB SHOCKS GMC TRUCK CAB SHOCKS INTERNATIONAL (NAVISTAR) CAB SHOCKS KENWORTH CAB SHOCKS LINK MANUFACTURING CAB SHOCKS MARMON CAB SHOCKS OSHKOSH MOTORS CAB SHOCKS PETERBILT CAB SHOCKS	Not Req'd.	83044	W FREIGHTLINER CAB SHOCKS	Not Req'd.	83101	W INTERNATIONAL (NAVISTAR) MACK VOLVO	Not Req'd.
83022	W CNH GLOBAL N V WESTERN STAR CAB SHOCKS	Not Req'd.	83045	W MACK CAB SHOCKS VOLVO	140780(1)	83102	W THOMAS SCHOOL BUS	145089-000(2)
83023	W CHEVROLET TRUCK CAB SHOCKS FORD CAB SHOCKS FREIGHTLINER CAB SHOCKS GMC TRUCK CAB SHOCKS INTERNATIONAL (NAVISTAR) CAB SHOCKS KENWORTH CAB SHOCKS LINK MANUFACTURING CAB SHOCKS MACK CAB SHOCKS PETERBILT CAB SHOCKS VOLVO CAB SHOCKS WESTERN STAR CAB SHOCKS	Not Req'd.	83046	X CHEVROLET TRUCK CAB SHOCKS FORD CAB SHOCKS FREIGHTLINER CAB SHOCKS GMC TRUCK CAB SHOCKS INTERNATIONAL (NAVISTAR) CAB SHOCKS KENWORTH CAB SHOCKS LINK MANUFACTURING CAB SHOCKS MACK CAB SHOCKS MARMON CAB SHOCKS PETERBILT CAB SHOCKS VOLVO CAB SHOCKS WESTERN STAR CAB SHOCKS	Not Req'd.	83103	W INTERNATIONAL (NAVISTAR) MITSUBISHI-FUSO MOR-RYDE SUSPENSION VOLVO	145054(2)
83024	D KENWORTH CAB SHOCKS LINK MANUFACTURING CAB SHOCKS PETERBILT CAB SHOCKS	Not Req'd.	83047	D FREIGHTLINER CAB SHOCKS	404702(1)	83104	W GMC TRUCK HINO VOLVO	Not Req'd.
83025	C FORD CAB SHOCKS FREIGHTLINER CAB SHOCKS GMC TRUCK CAB SHOCKS INTERNATIONAL (NAVISTAR) CAB SHOCKS KENWORTH CAB SHOCKS LINK MANUFACTURING CAB SHOCKS PETERBILT CAB SHOCKS STERLING TRUCK CAB SHOCKS	Not Req'd.	83048	C VOLVO VOLVO CAB SHOCKS	Not Req'd.	83105	W MACK VOLVO	140780(1)
83026	W FREIGHTLINER CAB SHOCKS WESTERN STAR CAB SHOCKS	Not Req'd.	83049	D KENWORTH CAB SHOCKS LINK MANUFACTURING CAB SHOCKS PETERBILT CAB SHOCKS	Not Req'd.	83107	W FORD MAECO STERLING TRUCK	145080(2)
83027	D FREIGHTLINER CAB SHOCKS WESTERN STAR CAB SHOCKS	140126(1)	83050	W MACK CAB SHOCKS VOLVO CAB SHOCKS	140780(1)	83109	W FORD HENDRICKSON TRUCK SUSPENSION SYSTEMS MC NEILUS TRUCK & MAN. STERLING TRUCK	145128(1)
83028	D VOLVO CAB SHOCKS	Not Req'd.	83051	C INTERNATIONAL (NAVISTAR) CAB SHOCKS LINK MANUFACTURING CAB SHOCKS	Not Req'd.	83110	D HENDRICKSON TRUCK SUSPENSION SYSTEMS MACK VOLVO	145128(1)
83029	W VOLVO CAB SHOCKS	Not Req'd.	83052	W INTERNATIONAL (NAVISTAR) CAB SHOCKS LINK MANUFACTURING CAB SHOCKS	Not Req'd.	83111	D HENDRICKSON TRUCK SUSPENSION SYSTEMS MACK VOLVO WESTERN STAR	145128(1)
83030	W VOLVO CAB SHOCKS	Not Req'd.	83053	W INTERNATIONAL (NAVISTAR) CAB SHOCKS LINK MANUFACTURING CAB SHOCKS	Not Req'd.	83112	C ADVANCE MIXER AUTOCAR HENDRICKSON TRUCK SUSPENSION SYSTEMS INTERNATIONAL (NAVISTAR) MACK MC NEILUS TRUCK & MAN. VOLVO	Not Req'd.
83031	D KENWORTH CAB SHOCKS LINK MANUFACTURING CAB SHOCKS	Not Req'd.	83054	W INTERNATIONAL (NAVISTAR) CAB SHOCKS LINK MANUFACTURING CAB SHOCKS	Not Req'd.	83113	W SAF HOLLAND STOUGHTON TRAILERS INC. TRAILMOBILE CANADA CORP. WABASH NATIONAL	Not Req'd.
83032	S FREIGHTLINER CAB SHOCKS INTERNATIONAL (NAVISTAR) CAB SHOCKS KENWORTH CAB SHOCKS LINK MANUFACTURING CAB SHOCKS	Not Req'd.	83055	W KENWORTH CAB SHOCKS LINK MANUFACTURING CAB SHOCKS	Not Req'd.	83114	W CHEVROLET TRUCK (Also See GMC Truck) GMC TRUCK INTERNATIONAL (NAVISTAR) ISUZU NISSAN	140780(1)
83033	W FORD CAB SHOCKS FREIGHTLINER CAB SHOCKS STERLING TRUCK CAB SHOCKS	Not Req'd.	83056	W KENWORTH CAB SHOCKS LINK MANUFACTURING CAB SHOCKS	Not Req'd.	83115	X SAF HOLLAND TRAILMOBILE CANADA CORP.	Not Req'd.
83034	W FORD CAB SHOCKS FREIGHTLINER CAB SHOCKS STERLING TRUCK CAB SHOCKS	Not Req'd.	83057	W FREIGHTLINER CAB SHOCKS STERLING TRUCK CAB SHOCKS	Not Req'd.	83116	W FREIGHTLINER CUSTOM CHASSIS	Not Req'd.
83035	C KENWORTH PETERBILT CAB SHOCKS	Not Req'd.	83058	W MACK CAB SHOCKS	140780(1)	83117	W FREIGHTLINER FREIGHTLINER CUSTOM CHASSIS OSHKOSH MOTORS	404702(1)
83038	A FREIGHTLINER CAB SHOCKS	404702(1)	83059	W KENWORTH CAB SHOCKS PETERBILT CAB SHOCKS POWERPACKER CAB SHOCKS	Not Req'd.	83118	W FREIGHTLINER FREIGHTLINER CUSTOM CHASSIS MAECO OSHKOSH MOTORS UPS TRUCK	Not Req'd.

N = New, S = Superseded, X = Discontinued once inventory is gone

NUMERICAL LISTING LISTA NUMÉRICA LISTE NUMÉRIQUE

GABRIEL#	APPLICATION	MTG ACC PKG NO	GABRIEL#	APPLICATION	MTG ACC PKG NO	GABRIEL#	APPLICATION	MTG ACC PKG NO
83119	W FREIGHTLINER CUSTOM CHASSIS OSHKOSH MOTORS	Not Req'd.	83126	D TUTHILL TECHNOLOGIES VOLVO WABASH NATIONAL	Not Req'd.	83143	W PETERBILT	145128(1)
83120	W FREIGHTLINER FREIGHTLINER CUSTOM CHASSIS MAECO OSHKOSH MOTORS STERLING TRUCK THOMAS SCHOOL BUS UPS TRUCK VOLVO	145089-000(1) & 145143(1)	83127	B BLUEBIRD SCHOOL BUS FREIGHTLINER FREIGHTLINER CUSTOM CHASSIS HOLIDAY RAMBLER MC NEILUS TRUCK & MAN. OSHKOSH MOTORS SAF HOLLAND TRAILMOBILE CANADA CORP. VOLVO WABASH NATIONAL	Not Req'd.	83144	W HENDRICKSON TRUCK SUSPENSION SYSTEMS INTERNATIONAL (NAVISTAR)	Not Req'd.
83122	D ALLCO TRAILER AUTOCAR CHEVROLET TRUCK (Also See GMC Truck) FORD FREIGHTLINER FRUEHAUF GILLIG BROS. GMC TRUCK GREAT DANE TRAILER HENDRICKSON TRUCK SUSPENSION SYSTEMS HOLIDAY RAMBLER ISUZU KENWORTH LODAL, INC. MACK MAECO MARMON MC NEILUS TRUCK & MAN. MONACO OSHKOSH MOTORS PETERBILT REYCO SUSPENSION SAF HOLLAND TUTHILL TECHNOLOGIES VOLVO WESTERN STAR	Not Req'd.	83128	A EAST MANUFACTURING CORP. FREIGHTLINER GREAT DANE TRAILER HENDRICKSON TRAILER SUSPENSION SYSTEMS MC NEILUS TRUCK & MAN. REYCO SUSPENSION SAF HOLLAND STOUGHTON TRAILERS INC. TWIN COACH UTILITY TRAILER MANUFACTURING COMPANY VOLVO WABASH NATIONAL	Not Req'd.	83145	W FORD INTERNATIONAL (NAVISTAR)	Not Req'd.
83123	C FORD GILLIG BROS. HENDRICKSON TRUCK SUSPENSION SYSTEMS INTERNATIONAL (NAVISTAR) KENWORTH MACK MAECO MARMON MC NEILUS TRUCK & MAN. PETERBILT REYCO SUSPENSION SAF HOLLAND TUTHILL TECHNOLOGIES VOLVO WATSON & CHALIN MFG. INC.	Not Req'd.	83130	C W RIDEWELL CORPORATION SAF HOLLAND VOLVO WABASH NATIONAL	Not Req'd.	83146	W FORD INTERNATIONAL (NAVISTAR) STERLING TRUCK	Not Req'd.
83124	C BENSON TRUCK BODIES INC. BLUEBIRD SCHOOL BUS EAST MANUFACTURING CORP. KENWORTH PETERBILT SAF HOLLAND TRAILMOBILE CANADA CORP. TWIN COACH VOLVO WABASH NATIONAL	Not Req'd.	83131	W FORD	Not Req'd.	83147	B HENDRICKSON TRUCK SUSPENSION SYSTEMS MACK MC NEILUS TRUCK & MAN. THOMAS SCHOOL BUS	Not Req'd.
83125	A CASCADE TRAILER EAST MANUFACTURING CORP. FORD GENERAL TRAILER CO HENDRICKSON TRUCK SUSPENSION SYSTEMS HOLLAND - BINKLEY MACK MAECO PEERLESS TRAILER SAF HOLLAND STERLING TRUCK THE BINKLEY COMPANY TRAILMOBILE CANADA CORP. VOLVO WABASH NATIONAL WATSON & CHALIN MFG. INC.	Not Req'd.	83134	W FREIGHTLINER	145054(1)	83148	D HENDRICKSON TRUCK SUSPENSION SYSTEMS HINO MC NEILUS TRUCK & MAN.	Not Req'd.
83126	D CHEVROLET TRUCK (Also See GMC Truck) GMC TRUCK HINO INTERNATIONAL (NAVISTAR) KENWORTH MAECO PETERBILT REYCO SUSPENSION SAF HOLLAND	Not Req'd.	83135	C FORD IC CORPORATION INTERNATIONAL (NAVISTAR)	Not Req'd.	83149	W HENDRICKSON TRUCK SUSPENSION SYSTEMS	Not Req'd.
			83136	C CHAMPION TRANSIT CHEVROLET TRUCK (Also See GMC Truck) GMC TRUCK ISUZU KENWORTH PETERBILT VOLVO	145054(2)	83150	W HENDRICKSON TRAILER SUSPENSION SYSTEMS SAF HOLLAND	Not Req'd.
			83137	C BERING TRUCK CORP. BLUEBIRD SCHOOL BUS CHEVROLET TRUCK (Also See GMC Truck) GMC TRUCK HENDRICKSON TRUCK SUSPENSION SYSTEMS INTERNATIONAL (NAVISTAR) ISUZU KENWORTH MACK MC NEILUS TRUCK & MAN. PETERBILT SAF HOLLAND VOLVO WESTERN STAR	Not Req'd.	83153	W CHEVROLET TRUCK (Also See GMC Truck) GMC TRUCK	Not Req'd.
			83138	W MACK	145128(1)	83154	W FREIGHTLINER CUSTOM CHASSIS	145089-000(1)
			83140	W FORD HINO	415010-802(2) & 145148(2)	83155	W CHEVROLET TRUCK (Also See GMC Truck) GMC TRUCK	Not Req'd.
			83141	W HINO	415010-802(2) & 145148(2)	83156	W IC CORPORATION INTERNATIONAL (NAVISTAR)	Not Req'd.
			83142	W AUTOCAR FREIGHTLINER HENDRICKSON TRUCK SUSPENSION SYSTEMS KENWORTH MC NEILUS TRUCK & MAN. PETERBILT	145128(1)	83157	W FREIGHTLINER CUSTOM CHASSIS	Not Req'd.
			83143	W AUTOCAR FREIGHTLINER HENDRICKSON TRUCK SUSPENSION SYSTEMS INTERNATIONAL (NAVISTAR) KENWORTH MC NEILUS TRUCK & MAN.	145128(1)	83158	W MOTOR COACH INDUSTRIES	Not Req'd.
						83159	W GMC TRUCK ISUZU	TR0027(4)
						83160	W COACHMEN RV FLEETWOOD RV FOREST RIVER INC FREIGHTLINER CUSTOM CHASSIS GULF STREAM COACH HOLIDAY RAMBLER ITASCA KING OF THE ROAD MANDALAY COACH MONACO NEWMAR CORP THOR MOTOR COACH WINNEBAGO	Not Req'd.
						83161	W FORD GMC TRUCK NISSAN	140524(1) & 404702(1)
						83162	W NISSAN	140780(1) & 145116 & 406422 & 415010-802(1)
						83163	W IC CORPORATION INTERNATIONAL (NAVISTAR)	Not Req'd.
						83164	W FREIGHTLINER CUSTOM CHASSIS	Not Req'd.
						83166	W HENDRICKSON TRUCK SUSPENSION SYSTEMS HINO	Not Req'd.
						83167	W INTERNATIONAL (NAVISTAR)	Not Req'd.
						83168	W HENDRICKSON TRUCK SUSPENSION SYSTEMS HINO MC NEILUS TRUCK & MAN.	Not Req'd.

NUMERICAL LISTING LISTA NUMÉRICA LISTE NUMÉRIQUE

GABRIEL#	APPLICATION	MTG ACC PKG NO	GABRIEL#	APPLICATION	MTG ACC PKG NO	GABRIEL#	APPLICATION	MTG ACC PKG NO
83169	W IC CORPORATION INTERNATIONAL (NAVISTAR)	Not Req'd.	83209	D CHEVROLET TRUCK (Also See GMC Truck) FORD GMC TRUCK HENDRICKSON TRAILER SUSPENSION SYSTEMS HOLIDAY RAMBLER INTERNATIONAL (NAVISTAR) KENWORTH MACK MAECO MC NEILUS TRUCK & MAN. MONACO PETERBILT REYCO SUSPENSION SAF HOLLAND TRAILMOBILE CANADA CORP. TUTHILL TECHNOLOGIES VOLVO WESTERN STAR	Not Req'd.	83221	W PAI CORP PETERBILT REYCO SUSPENSION TUTHILL TECHNOLOGIES VOLVO	Not Req'd.
83171	W ARVIN MERITOR WORKHORSE	Not Req'd.	83214	W CHEVROLET TRUCK (Also See GMC Truck) DIAMOND-REO EAST MANUFACTURING CORP. GMC TRUCK GRANNING SUSPENSION MAECO OSTERLUND TRUCK OTTAWA TRUCK SPARTAN MOTORS TUTHILL TECHNOLOGIES VOLVO	401754(4)	83225	W ACF BRILL BUS FORD FREIGHTLINER HENDRICKSON TRUCK SUSPENSION SYSTEMS INTERNATIONAL (NAVISTAR) MACK MOHAWK TRAILMOBILE CANADA CORP. VOLVO	401754(4)
83174	N FREIGHTLINER CUSTOM CHASSIS	Not Req'd.	83215	W ACF BRILL BUS BROCKWAY SCHOOL BUS CHEVROLET TRUCK (Also See GMC Truck) FORD GMC TRUCK HINO INTERNATIONAL (NAVISTAR) MACK MAECO PAI CORP REYCO SUSPENSION STERLING TRUCK TUTHILL TECHNOLOGIES VOLVO	401754(4)	83242	W MACK VOLVO	Not Req'd.
83175	N FORD INTERNATIONAL (NAVISTAR)	Not Req'd.	83216	W AUTOCAR BROCKWAY SCHOOL BUS CHEVROLET TRUCK (Also See GMC Truck) FORD GILLIG BROS. GMC TRUCK HINO INTERNATIONAL (NAVISTAR) MACK MAECO MARMON MOHAWK NEOPLAN BUS ONEIDA PRODUCTS STERLING TRUCK VOLVO WESTERN STAR	140149(1)	83301	W INTERNATIONAL (NAVISTAR) VOLVO	141083(1)
83176	N MAECO	Not Req'd.	83217	W CHEVROLET TRUCK (Also See GMC Truck) DIAMOND-REO EAST MANUFACTURING CORP. FLXIBLE BUS FORD GMC TRUCK HINO HYSTER MACK MAECO OLE GRANNING OTTAWA TRUCK REYCO SUSPENSION SOUTHERN COACH TUTHILL TECHNOLOGIES VOLVO	401754(4)	83303	W CHEVROLET TRUCK (Also See GMC Truck) GMC TRUCK VOLVO	140702(1)
83177	N 140780(1) & 404702(1) BLUEBIRD SCHOOL BUS HOLIDAY RAMBLER THOMAS SCHOOL BUS		83219	W CHEVROLET TRUCK (Also See GMC Truck) FORD GILLIG BROS. GMC TRUCK PETERBILT VOLVO	140149(1)	83304	W CHEVROLET TRUCK (Also See GMC Truck) GMC TRUCK VOLVO	140702(1)
83178	N 142095(1) BLUEBIRD SCHOOL BUS HOLIDAY RAMBLER THOMAS SCHOOL BUS		83221	W CHEVROLET TRUCK (Also See GMC Truck) GMC TRUCK KENWORTH MACK MAECO OSHKOSH MOTORS	Not Req'd.	83308	W CHEVROLET TRUCK (Also See GMC Truck) FORD GMC TRUCK INTERNATIONAL (NAVISTAR) STERLING TRUCK VOLVO	140149(1)
83180	N INTERNATIONAL (NAVISTAR)	Not Req'd.	83221	W CHEVROLET TRUCK (Also See GMC Truck) GMC TRUCK KENWORTH MACK MAECO OSHKOSH MOTORS	Not Req'd.	83309	W FORD INTERNATIONAL (NAVISTAR) STERLING TRUCK VOLVO	140149(1)
83200	S FORD STERLING TRUCK	140149(1)	83221	W CHEVROLET TRUCK (Also See GMC Truck) GMC TRUCK KENWORTH MACK MAECO OSHKOSH MOTORS	Not Req'd.	83312	D FORD KENWORTH OSHKOSH MOTORS PETERBILT PIERCE MANUFACTURING INC. VOLVO	140149(1)
83203	A Not Req'd. CHANCE BUS CHEVROLET TRUCK (Also See GMC Truck) DURA SUSPENSION FRUEHAUF GMC TRUCK HIGHWAY PRODUCT HUTCHENS SUSPENSION MACK MAECO MOHAWK ORION BUS INDUSTRIES PAGE SUSPENSION PETERBILT REYCO SUSPENSION RIDEWELL CORPORATION SAF HOLLAND TUTHILL TECHNOLOGIES VOLVO WABASH NATIONAL WATSON & CHALIN MFG. INC.		83221	W CHEVROLET TRUCK (Also See GMC Truck) GMC TRUCK KENWORTH MACK MAECO OSHKOSH MOTORS	Not Req'd.	83314	W FORD GMC TRUCK INTERNATIONAL (NAVISTAR) MAECO STERLING TRUCK VOLVO	140149(1)
83204	W Not Req'd. DUPLIX TRUCK DURA SUSPENSION MAECO PAGE SUSPENSION REYCO SUSPENSION SAF HOLLAND TRAILMOBILE CANADA CORP. TUTHILL TECHNOLOGIES VOLVO WATSON & CHALIN MFG. INC.		83221	W CHEVROLET TRUCK (Also See GMC Truck) GMC TRUCK KENWORTH MACK MAECO OSHKOSH MOTORS	Not Req'd.	83317	D 141083(1) DINA BUS FORD IC CORPORATION INTERNATIONAL (NAVISTAR) VOLVO	
83207	C Not Req'd. ADVANCE MIXER BLUEBIRD SCHOOL BUS BROCKWAY SCHOOL BUS CHANCE BUS CHEVROLET TRUCK (Also See GMC Truck) DURA SUSPENSION FORD GILLIG BROS. GMC TRUCK GREAT DANE TRAILER HARDEE MFG HENDRICKSON TRUCK SUSPENSION SYSTEMS HIGHWAY PRODUCT INTERNATIONAL (NAVISTAR) MACK MAECO MC NEILUS TRUCK & MAN. MOHAWK NATIONAL COACH CORP OSHKOSH MOTORS REYCO SUSPENSION RIDEWELL CORPORATION SAF HOLLAND TRAILMOBILE CANADA CORP. TUTHILL TECHNOLOGIES TWIN COACH VOLVO WABASH NATIONAL		83221	W CHEVROLET TRUCK (Also See GMC Truck) GMC TRUCK KENWORTH MACK MAECO OSHKOSH MOTORS	Not Req'd.	83318	W 141083(2) INTERNATIONAL (NAVISTAR) VOLVO	
83209	D Not Req'd. ADVANCE MIXER		83221	W CHEVROLET TRUCK (Also See GMC Truck) GMC TRUCK KENWORTH MACK MAECO OSHKOSH MOTORS	Not Req'd.	83353	X 145099(1) KENWORTH PETERBILT VOLVO	

N = New, S = Superseded, X = Discontinued once inventory is gone

NUMERICAL LISTING LISTA NUMÉRICA LISTE NUMÉRIQUE

GABRIEL#	APPLICATION	MTG ACC PKG NO	GABRIEL#	APPLICATION	MTG ACC PKG NO	GABRIEL#	APPLICATION	MTG ACC PKG NO
83401	W WESTERN STAR	404702(2)	85005	B MAECO MERCEDES BENZ REYCO SUSPENSION RIDEWELL CORPORATION SAF HOLLAND TUTHILL TECHNOLOGIES VOLVO WATSON & CHALIN MFG. INC.	Not Req'd.	85014	C REYCO SUSPENSION RIDEWELL CORPORATION SAF HOLLAND TUTHILL TECHNOLOGIES WATSON & CHALIN MFG. INC.	Not Req'd.
83404	W GMC TRUCK HINO INTERNATIONAL (NAVISTAR) ISUZU	401011(4)	85006	A BLUEBIRD SCHOOL BUS BUILT RITE DEXTER AXLE FORD FREIGHTLINER FREIGHTLINER CUSTOM CHASSIS GREAT DANE TRAILER HENDRICKSON TRAILER SUSPENSION SYSTEMS HENDRICKSON TRUCK SUSPENSION SYSTEMS MAECO MERCEDES BENZ RAMERIZ TRAILER REYCO SUSPENSION RIDEWELL CORPORATION SAF HOLLAND STERLING TRUCK STOUGHTON TRAILERS INC. THE BINKLEY COMPANY THOMAS SCHOOL BUS TRAILMOBILE CANADA CORP. TUTHILL TECHNOLOGIES VOLVO WESTERN STAR	Not Req'd.	85023	D INTERNATIONAL (NAVISTAR) KENWORTH MACK PETERBILT VOLVO	140149(1)
83456	C IC CORPORATION INTERNATIONAL (NAVISTAR) MITSUBISHI-FUSO VOLVO	142998(2)	85007	D FREIGHTLINER KENWORTH MACK MAECO PETERBILT REYCO SUSPENSION SPARTAN MOTORS TUTHILL TECHNOLOGIES VOLVO	401754(4)	85024	W AUTOCAR INTERNATIONAL (NAVISTAR) MACK VOLVO	140149(1)
83515	N CHEVROLET TRUCK (Also See GMC Truck) GMC TRUCK ISUZU VOLVO	141041(1) & TR0027(2)	85009	W ARVIN MERITOR FREIGHTLINER MITSUBISHI-FUSO NEOPLAN BUS WATSON & CHALIN MFG. INC.	145054(1)	85025	W VOLVO	140169(1) & 145054(1)
83518	N HINO	141041(1) & TR0027(2)	85010	W BLUEBIRD SCHOOL BUS HENDRICKSON TRAILER SUSPENSION SYSTEMS MACK	Not Req'd.	85026	W AUTOCAR GMC TRUCK VOLVO	145054(1)
83519	N HINO	TR0027(4)	85011	W FREIGHTLINER	Not Req'd.	85027	W AUTOCAR INTERNATIONAL (NAVISTAR) VOLVO	145054(2)
83613	D INTERNATIONAL (NAVISTAR) THOMAS SCHOOL BUS VOLVO	141083(2)	85012	A ARVIN MERITOR BLUEBIRD SCHOOL BUS BROCKWAY SCHOOL BUS CHANGE COACH CHEVROLET TRUCK (Also See GMC Truck) FORD GMC TRUCK INTERNATIONAL (NAVISTAR) ISUZU KENWORTH PETERBILT VOLVO	145080(2)	85029	B BLUEBIRD SCHOOL BUS COACHMEN RV DURA SUSPENSION EAST MANUFACTURING CORP. FLEETWOOD RV FOREST RIVER INC FREIGHTLINER CUSTOM CHASSIS GULF STREAM COACH HENDRICKSON TRAILER SUSPENSION SYSTEMS HOLIDAY RAMBLER INTERNATIONAL (NAVISTAR) ITASCA KENWORTH KING OF THE ROAD MANDALAY COACH MONACO NEWMAR CORP PAGE SUSPENSION PETERBILT RIDEWELL CORPORATION SAF HOLLAND SPARTAN MOTORS THOR MOTOR COACH TRAILMOBILE CANADA CORP. WATSON & CHALIN MFG. INC. WINNEBAGO	Not Req'd.
83634	X FREIGHTLINER	Not Req'd.	85013	C BLUEBIRD SCHOOL BUS FORD HENDRICKSON TRAILER SUSPENSION SYSTEMS HENDRICKSON TRUCK SUSPENSION SYSTEMS INTERNATIONAL (NAVISTAR) KENWORTH MAECO MC NEILUS TRUCK & MAN. PETERBILT REYCO SUSPENSION SAF HOLLAND SPARTAN MOTORS STERLING TRUCK TRAILMOBILE CANADA CORP. TUTHILL TECHNOLOGIES VOLVO	Not Req'd.	85030	C BLUEBIRD SCHOOL BUS CHEVROLET TRUCK (Also See GMC Truck) EAST MANUFACTURING CORP. FORD FRUEHAUF GMC TRUCK HENDRICKSON TRAILER SUSPENSION SYSTEMS HENDRICKSON TRUCK SUSPENSION SYSTEMS INTERNATIONAL (NAVISTAR) MAECO OSHKOSH MOTORS PACIFIC TRUCK & TRAILER PIERCE MANUFACTURING INC. REYCO SUSPENSION SAF HOLLAND STERLING TRUCK THOMAS SCHOOL BUS TUTHILL TECHNOLOGIES VOLVO WABASH NATIONAL	Not Req'd.
83635	W SAF HOLLAND VOLVO WESTERN STAR	145054(1)	85014	C ARVIN MERITOR CHANGE BUS DINA BUS HARDEE MFG HENDRICKSON TRAILER SUSPENSION SYSTEMS INTERNATIONAL (NAVISTAR) MACK	Not Req'd.	85031	C KENWORTH PETERBILT	140169(1) & TR0027(2)
83636	X INTERNATIONAL (NAVISTAR) VOLVO	Not Req'd.	85015	C INTERNATIONAL (NAVISTAR) KENWORTH MACK PACCAR PETERBILT VOLVO	Not Req'd.	85033	A INTERNATIONAL (NAVISTAR) KENWORTH MACK PETERBILT VOLVO	145099(1)
85000	A ARVIN MERITOR BENSON TRUCK BODIES INC. EAST MANUFACTURING CORP. FREIGHTLINER GREAT DANE TRAILER HENDRICKSON TRAILER SUSPENSION SYSTEMS KENWORTH MC NEILUS TRUCK & MAN. ORION BUS INDUSTRIES PETERBILT RIDEWELL CORPORATION SAF HOLLAND STOUGHTON TRAILERS INC. THOMAS SCHOOL BUS TRAILMOBILE CANADA CORP. TWIN COACH UTILITY TRAILER MANUFACTURING COMPANY VOLVO WABASH NATIONAL WATSON & CHALIN MFG. INC.	Not Req'd.	85016	C INTERNATIONAL (NAVISTAR) KENWORTH MACK MAECO PETERBILT REYCO SUSPENSION STERLING TRUCK TUTHILL TECHNOLOGIES VOLVO	Not Req'd.	85036	D BLUEBIRD SCHOOL BUS HENDRICKSON TRUCK SUSPENSION SYSTEMS MACK PETERBILT SPARTAN MOTORS	Not Req'd.
85001	A FORD INTERNATIONAL (NAVISTAR) KENWORTH MACK MAECO PETERBILT REYCO SUSPENSION STERLING TRUCK TUTHILL TECHNOLOGIES VOLVO	401754(4)	85017	C INTERNATIONAL (NAVISTAR) KENWORTH MACK PETERBILT VOLVO	Not Req'd.			
85003	A INTERNATIONAL (NAVISTAR) KENWORTH MARMON PETERBILT VOLVO	Not Req'd.						
85004	W PETERBILT SAF HOLLAND	401754(4)						
85005	B AUTOCAR BLUEBIRD SCHOOL BUS BOYDSTUN EQUIPMENT MANUFACTURING CHEVROLET TRUCK (Also See GMC Truck) EAST MANUFACTURING CORP. FREIGHTLINER FREIGHTLINER CUSTOM CHASSIS GMC TRUCK HENDRICKSON TRAILER SUSPENSION SYSTEMS HENDRICKSON TRUCK SUSPENSION SYSTEMS INTERNATIONAL (NAVISTAR) MACK	Not Req'd.						

N = New, X = Discontinued once inventory is gone

NUMERICAL LISTING LISTA NUMÉRICA LISTE NUMÉRIQUE

GABRIEL#	APPLICATION	MTG ACC PKG NO	GABRIEL#	APPLICATION	MTG ACC PKG NO	GABRIEL#	APPLICATION	MTG ACC PKG NO
85036	D VOLVO	Not Req'd.	85060	D CHALMERS SUSPENSION FREIGHTLINER INTERNATIONAL (NAVISTAR) KENWORTH PETERBILT SAF HOLLAND VOLVO WATSON & CHALIN MFG. INC. WESTERN STAR	Not Req'd.	85087	W MC NEILUS TRUCK & MAN.	Not Req'd.
85040	W FORD STERLING TRUCK VOLVO	401754(4)	85061	A MACK VOLVO	Not Req'd.	85088	B MACK VOLVO	Not Req'd.
85042	W FREIGHTLINER VOLVO	401754(4)	85062	A KENWORTH PETERBILT VOLVO	145080(2)	85090	W BLUEBIRD SCHOOL BUS	Not Req'd.
85043	C FREIGHTLINER FREIGHTLINER CUSTOM CHASSIS HENDRICKSON TRAILER SUSPENSION SYSTEMS STERLING TRUCK	Not Req'd.	85063	W FORD MAECO STERLING TRUCK	145080(2)	85091	W THOMAS SCHOOL BUS	Not Req'd.
85045	A ARVIN MERITOR HENDRICKSON TRAILER SUSPENSION SYSTEMS INGERSOLL AXLES MUNCIE RECLAMATION REYCO SUSPENSION RIDEWELL CORPORATION SAF HOLLAND TUTHILL TECHNOLOGIES UTILITY TRAILER MANUFACTURING COMPANY VOLVO WABASH NATIONAL WATSON & CHALIN MFG. INC.	Not Req'd.	85064	C GREAT DANE TRAILER HENDRICKSON TRAILER SUSPENSION SYSTEMS WATSON & CHALIN MFG. INC.	Not Req'd.	85092	W FREIGHTLINER CUSTOM CHASSIS	145054(1)
85046	W AUTOCAR VOLVO	140149(1)	85065	W VOLVO	145128(1) & 145144(1)	85097	W FREIGHTLINER CUSTOM CHASSIS HOLIDAY RAMBLER MONACO SAF HOLLAND	Not Req'd.
85047	C FORD KENWORTH PETERBILT STERLING TRUCK VOLVO	140149(1)	85066	A MACK VOLVO	Not Req'd.	85098	B MACK VOLVO	Not Req'd.
85050	S CHEVROLET TRUCK (Also See GMC Truck) GMC TRUCK	Not Req'd.	85067	A KENWORTH PETERBILT VOLVO	Not Req'd.	85099	W SAF HOLLAND	Not Req'd.
85051	D BLUEBIRD SCHOOL BUS GILLIG BROS. MUNCIE RECLAMATION OSHKOSH MOTORS REYCO SUSPENSION SAF HOLLAND STOUGHTON TRAILERS INC. TRAILMOBILE CANADA CORP. TUTHILL TECHNOLOGIES WABASH NATIONAL	Not Req'd.	85069	A ARVIN MERITOR KENWORTH PETERBILT VOLVO	145089-000(2)	85102	W HENDRICKSON TRUCK SUSPENSION SYSTEMS INTERNATIONAL (NAVISTAR)	Not Req'd.
85052	A ARVIN MERITOR BLUEBIRD SCHOOL BUS GREAT DANE TRAILER HENDRICKSON TRAILER SUSPENSION SYSTEMS INGERSOLL AXLES REYCO SUSPENSION SAF HOLLAND TUTHILL TECHNOLOGIES VOLVO WABASH NATIONAL WATSON & CHALIN MFG. INC.	Not Req'd.	85070	A KENWORTH PETERBILT VOLVO	401754(2)	85106	W BLUEBIRD SCHOOL BUS	Not Req'd.
85053	C WESTERN STAR	145126(2)	85071	W CHEVROLET TRUCK (Also See GMC Truck) GMC TRUCK ISUZU	145054(2)	85109	N KENWORTH PETERBILT SAF HOLLAND VOLVO WESTERN STAR	Not Req'd.
85054	W FORD STERLING TRUCK	145080(2)	85072	C AUTOCAR HENDRICKSON TRUCK SUSPENSION SYSTEMS INTERNATIONAL (NAVISTAR) KENWORTH MACK MC NEILUS TRUCK & MAN. VOLVO	Not Req'd.	85119	N KENWORTH PETERBILT	Not Req'd.
85055	W FORD STERLING TRUCK	145080(2)	85078	W DANA WABASH NATIONAL	Not Req'd.	85120	N MACK	Not Req'd.
85058	B BLUEBIRD SCHOOL BUS FREIGHTLINER FREIGHTLINER CUSTOM CHASSIS INTERNATIONAL (NAVISTAR) OSHKOSH MOTORS PIERCE MANUFACTURING INC. THOMAS SCHOOL BUS VOLVO	Not Req'd.	85079	W HENDRICKSON TRAILER SUSPENSION SYSTEMS MC NEILUS TRUCK & MAN.	Not Req'd.	85122	N FREIGHTLINER CUSTOM CHASSIS THOMAS SCHOOL BUS	145089-000(1)
85059	W RED LION TRAILER SAF HOLLAND STOUGHTON TRAILERS INC. TRAILMOBILE CANADA CORP. WABASH NATIONAL	Not Req'd.	85080	W MACK VOLVO	145054(1)	85123	N FREIGHTLINER	145090(1)
85060	D AUTOCAR	Not Req'd.	85081	W VOLVO	145090(1)	85124	N ITASCA WORKHORSE	145054(2)
			85082	W IC CORPORATION INTERNATIONAL (NAVISTAR)	Not Req'd.	85125	N ITASCA MONACO WORKHORSE	Not Req'd.
			85083	W HENDRICKSON TRUCK SUSPENSION SYSTEMS	145128(1)	85126	N MONACO WORKHORSE	145054(1)
			85084	D KENWORTH PETERBILT	Not Req'd.	85180	N FORD	Not Req'd.
			85085	W NISSAN	145054(2)	85181	N FORD	Not Req'd.
			85086	W BLUEBIRD SCHOOL BUS REYCO SUSPENSION	Not Req'd.	85300	C CHEVROLET TRUCK (Also See GMC Truck) FREIGHTLINER FRUEHAUF GMC TRUCK GRANNING SUSPENSION HOBBS TRAILERS INTERNATIONAL (NAVISTAR) MAECO MUNCIE RECLAMATION OSHKOSH MOTORS OSTERLUND TRUCK OTTAWA TRUCK PIERCE MANUFACTURING INC. REYCO SUSPENSION SAF HOLLAND SEAGRAVE FIRE APPARATUS LLC TUTHILL TECHNOLOGIES VOLVO WABASH NATIONAL WATSON & CHALIN MFG. INC. WESTERN UNIT "STABILAIRE" SUSPENSION	401754(4)
			85087	W HENDRICKSON TRUCK SUSPENSION SYSTEMS	Not Req'd.	85301	W BECK BUS CHEVROLET TRUCK (Also See GMC Truck)	401754(4)

N = New, S = Superseded

NUMERICAL LISTING LISTA NUMÉRICA LISTE NUMÉRIQUE

GABRIEL#	APPLICATION	MTG ACC PKG NO	GABRIEL#	APPLICATION	MTG ACC PKG NO	GABRIEL#	APPLICATION	MTG ACC PKG NO
85301	W CLARK EQUIPMENT FLXIBLE BUS FORD FREIGHTLINER GMC TRUCK HENDRICKSON TRAILER SUSPENSION SYSTEMS SAF HOLLAND STERLING TRUCK VOLVO	401754(4)	85305	W FORD FRUEHAUF GMC TRUCK HENDRICKSON TRUCK SUSPENSION SYSTEMS MACK MAECO MC NEILUS TRUCK & MAN. MOHAWK PAI CORP RIDEWELL CORPORATION VOLVO WESTERN STAR WESTERN UNIT "STABILAIRE" SUSPENSION	401754(4)	85314	W AUTOCAR CHALMERS SUSPENSION EAGLE MOTOR COACH FORD KENWORTH MAECO PETERBILT STERLING TRUCK VOLVO	401754(4)
85302	D AM GENERAL CHEVROLET TRUCK (Also See GMC Truck) CRANE CARRIER FORD FREIGHTLINER FWD TRUCK GILLIG BROS. GMC TRUCK KENWORTH MACK MAECO MOTOR COACH INDUSTRIES PETERBILT RIDEWELL CORPORATION VOLVO	401754(4)	85307	W ACF BRILL BUS BECK BUS BLUEBIRD SCHOOL BUS BROCKWAY SCHOOL BUS BUS & TRUCK CO. CHEVROLET TRUCK (Also See GMC Truck) CLARK EQUIPMENT CONTINENTAL TRAILWAYS-EAGLE INT'L CRANE CARRIER DIAMOND-REO DINA BUS EAGLE MOTOR COACH FLXIBLE BUS FORD GMC TRUCK HENDRICKSON TRUCK SUSPENSION SYSTEMS INTERNATIONAL (NAVISTAR) MACK MAECO ONEIDA PRODUCTS ORION BUS INDUSTRIES PIERCE MANUFACTURING INC. REYCO SUSPENSION RIDEWELL CORPORATION SPARTAN MOTORS THOMAS SCHOOL BUS VOLVO WESTERN STAR WESTERN UNIT "STABILAIRE" SUSPENSION	401754(4)	85315	W CLARK EQUIPMENT CUNHA PRODUCTS OHV FORD JIFFLOX KWK-LOC (JIFFLOX) VOLVO WESTERN STAR	401754(4)
85303	D ACF BRILL BUS Beck BROCKWAY SCHOOL BUS BUS & TRUCK CO. CHEVROLET TRUCK (Also See GMC Truck) CONTINENTAL TRAILWAYS-EAGLE INT'L CRANE CARRIER CROWN COACH Dina EAGLE MOTOR COACH GMC TRUCK GREYHOUND BUS HENDRICKSON TRUCK SUSPENSION SYSTEMS INTERNATIONAL (NAVISTAR) KENWORTH MACK MAECO MATSON SCHOOL BUS MCI MC NEILUS TRUCK & MAN. MOHAWK MOTOR COACH INDUSTRIES OISA ORION BUS INDUSTRIES OSHKOSH MOTORS OTTAWA TRUCK Peña PETERBILT PREVOST Ramírez Sultana TRANSPORTATION MFG. CORP VOLVO Volvo WESTERN STAR	401754(4)	85308	W ACF BRILL BUS CHEVROLET TRUCK (Also See GMC Truck) EAGLE MOTOR COACH FREIGHTLINER GMC TRUCK HAULMARK HINO INTERNATIONAL (NAVISTAR) KENWORTH MACK MAECO MITSUBISHI-FUSO MOHAWK NISSAN ORION BUS INDUSTRIES PETERBILT PREVOST THOMAS SCHOOL BUS VOLVO WESTERN STAR WESTERN UNIT "STABILAIRE" SUSPENSION	401754(4)	85316	C INTERNATIONAL (NAVISTAR) MACK MAECO OSHKOSH MOTORS PIERCE MANUFACTURING INC. VOLVO	145090(1)
85304	W BECK BUS BLUEBIRD SCHOOL BUS BROCKWAY SCHOOL BUS CHEVROLET TRUCK (Also See GMC Truck) CONTINENTAL TRAILWAYS-EAGLE INT'L CRANE CARRIER CROWN COACH DIAMOND-REO DIAMOND T EAGLE MOTOR COACH FLXIBLE BUS FORD FRUEHAUF GILLIG BROS. GMC TRUCK MACK OSHKOSH MOTORS PIERCE MANUFACTURING INC. RIDEWELL CORPORATION SAF HOLLAND SOUTHERN COACH SPARTAN MOTORS THOMAS SCHOOL BUS UNITED MANUFACTURING VOLVO WESTERN STAR WESTERN UNIT "STABILAIRE" SUSPENSION	401754(4)	85310	A INTERNATIONAL (NAVISTAR) KENWORTH MACK OTTAWA TRUCK PETERBILT VOLVO	141108(1)	85318	W GILLIG BROS. HAUSMAN VOLVO	145054(2)
85305	W BROCKWAY SCHOOL BUS BUS & TRUCK CO. CHEVROLET TRUCK (Also See GMC Truck) CONTINENTAL TRAILWAYS-EAGLE INT'L EAGLE MOTOR COACH FLXIBLE BUS	401754(4)	85311	A FLXIBLE BUS INTERNATIONAL (NAVISTAR) KENWORTH LEYLAND TRUCK MACK PETERBILT VOLVO	141247(1)	85319	C FREIGHTLINER INTERNATIONAL (NAVISTAR) KENWORTH MACK PETERBILT VOLVO	145089-000(1)
			85312	S MOTOR COACH INDUSTRIES TRANSPORTATION MFG. CORP	141247(1)	85320	A FREIGHTLINER KENWORTH MAECO PETERBILT VOLVO	401754(4)
			85313	W FLXIBLE BUS GMC TRUCK GREYHOUND BUS MAECO MOTOR COACH INDUSTRIES NOVA BUS REYCO SUSPENSION TRANSPORTATION MFG. CORP TUTHILL TECHNOLOGIES	401754(4)	85321	D ARVIN MERITOR FRUEHAUF HOLLAND - BINKLEY MACK SAF HOLLAND VOLVO WABASH NATIONAL WATSON & CHALIN MFG. INC.	Not Req'd.
						85322	W FRUEHAUF VOLVO WABASH NATIONAL	401754(2)
						85323	A EAST MANUFACTURING CORP. GREAT DANE TRAILER HENDRICKSON TRAILER SUSPENSION SYSTEMS INGERSOLL AXLES KENWORTH MC NEILUS TRUCK & MAN. SAF HOLLAND UTILITY TRAILER MANUFACTURING COMPANY VOLVO WABASH NATIONAL WATSON & CHALIN MFG. INC.	Not Req'd.
						85324	S CHAMPION TRANSIT CHEVROLET TRUCK (Also See GMC Truck) GMC TRUCK ISUZU MERCEDES BENZ	145054(2)
						85327	W FRUEHAUF	401754(2)
						85329	W ARVIN MERITOR BLUEBIRD SCHOOL BUS PREVOST	401754(4)
						85330	S PREVOST	145054(1)
						85331	C FREIGHTLINER FREIGHTLINER CUSTOM CHASSIS WESTERN STAR	Not Req'd.
						85332	W IC CORPORATION INTERNATIONAL (NAVISTAR)	145128(1)

S = Superseded

NUMERICAL LISTING LISTA NUMÉRICA LISTE NUMÉRIQUE

GABRIEL#	APPLICATION	MTG ACC PKG NO	GABRIEL#	APPLICATION	MTG ACC PKG NO	GABRIEL#	APPLICATION	MTG ACC PKG NO
85333	W INTERNATIONAL (NAVISTAR)	145128(1)	85700	W MUNCIE RECLAMATION NOVA BUS ORION BUS INDUSTRIES PREVOST SICARD TRANSPORTATION MFG. CORP VOLVO	401754(4)	85710	X 141247(1) & 401754(2) CHEVROLET TRUCK (Also See GMC Truck) FLXIBLE BUS GMC TRUCK MOTOR COACH INDUSTRIES MUNCIE RECLAMATION NEW FLYER NOVA BUS PREVOST TRANSPORTATION MFG. CORP	
85334	D ADVANCE MIXER MAECO MC NEILUS TRUCK & MAN. REYCO SUSPENSION	401754(4)	85701	X 145054(2) CHEVROLET TRUCK (Also See GMC Truck) FLXIBLE BUS GMC TRUCK MAECO MOHAWK MOTOR COACH INDUSTRIES MUNCIE RECLAMATION NOVA BUS TRANSPORTATION MFG. CORP VOLVO		85711	W 141247(1) & 401754(2) CHEVROLET TRUCK (Also See GMC Truck) FLXIBLE BUS FLYER INDUSTRIES GMC TRUCK MAECO MOTOR COACH INDUSTRIES NEW FLYER ORION BUS INDUSTRIES TRANSPORTATION MFG. CORP VOLVO	
85335	W FREIGHTLINER	Not Req'd.	85702	W 401754(4) CHEVROLET TRUCK (Also See GMC Truck) FLXIBLE BUS GMC TRUCK HAUSMAN MACK MOHAWK MOTOR COACH INDUSTRIES MUNCIE RECLAMATION NOVA BUS PREVOST REYCO SUSPENSION RIDEWELL CORPORATION TRANSPORTATION MFG. CORP TUTHILL TECHNOLOGIES VOLVO		85712	D 401754(4) ARVIN MERITOR BLUEBIRD SCHOOL BUS CARPENTER BUS DIAMOND-REO FLUIDRIVE FLXIBLE BUS FORD GILLIG BROS. GRANNING SUSPENSION HENDRICKSON TRAILER SUSPENSION SYSTEMS MERITOR ORION BUS INDUSTRIES OSTERLUND TRUCK RAYDAN MANUFACTURING RIDEWELL CORPORATION SPARTAN MOTORS THOMAS SCHOOL BUS TUTHILL TECHNOLOGIES VOLVO	
85336	W CHEVROLET TRUCK (Also See GMC Truck) GMC TRUCK ISUZU PETERBILT	145054(2)	85703	X 141247(1) & 401754(2) FLXIBLE BUS GRUMMAN BUS MOHAWK MUNCIE RECLAMATION VOLVO		85713	W 401754(4) CARPENTER BUS CRANE CARRIER EAGLE MOTOR COACH MOTOR COACH INDUSTRIES MUNCIE RECLAMATION NOVA BUS PREVOST THOMAS SCHOOL BUS TRANSPORTATION MFG. CORP	
85337	W HENDRICKSON TRAILER SUSPENSION SYSTEMS	Not Req'd.	85704	W 401754(4) ARVIN MERITOR CHEVROLET TRUCK (Also See GMC Truck) FLXIBLE BUS GMC TRUCK GRUMMAN BUS MOHAWK MOTOR COACH INDUSTRIES MUNCIE RECLAMATION REYCO SUSPENSION RIDEWELL CORPORATION TUTHILL TECHNOLOGIES VOLVO		85714	S 145093(1) MOHAWK ORION BUS INDUSTRIES	
85338	W HENDRICKSON TRAILER SUSPENSION SYSTEMS UTILITY TRAILER MANUFACTURING COMPANY	Not Req'd.	85705	W 145090(2) FLXIBLE BUS INTERNATIONAL (NAVISTAR) MUNCIE RECLAMATION NEOPLAN BUS VOLVO		85715	W 145093(1) MOHAWK ORION BUS INDUSTRIES	
85339	W 401754(4) MAECO MOTOR COACH INDUSTRIES PREVOST TRANSPORTATION MFG. CORP VOLVO		85706	W 145090(2) HAUSMAN NEOPLAN BUS VOLVO		85716	W 145093(1) DINA BUS FLXIBLE BUS FORD GILLIG BROS. MAECO NEW FLYER ORION BUS INDUSTRIES	
85340	W 145089-000(1) MOTOR COACH INDUSTRIES		85707	X 145090(2) ARVIN MERITOR FLXIBLE BUS MOHAWK MOTOR COACH INDUSTRIES MUNCIE RECLAMATION NEOPLAN BUS		85717	S 145093(1) MOHAWK ORION BUS INDUSTRIES REYCO SUSPENSION TUTHILL TECHNOLOGIES	
85341	W 145089-000(1) MOTOR COACH INDUSTRIES		85708	C 145090(2) ABC BUS ARVIN MERITOR CHEVROLET TRUCK (Also See GMC Truck) FLXIBLE BUS FLYER INDUSTRIES GILLIG BROS. GMC TRUCK M.A.N. BUS MOTOR COACH INDUSTRIES MUNCIE RECLAMATION NEW FLYER PREVOST VAN HOOL VOLVO		85718	S 145093(1) FLXIBLE BUS MOHAWK NEW FLYER ORION BUS INDUSTRIES	
85342	W 145054(2) CHEVROLET TRUCK (Also See GMC Truck) GMC TRUCK		85709	W 145090(2) ABC BUS M.A.N. BUS MOTOR COACH INDUSTRIES MUNCIE RECLAMATION VOLVO		85719	X 145093(1) ORION BUS INDUSTRIES	
85343	W 145089-000(1) & 401754(2) KENWORTH PETERBILT					85720	D 401754(4) NEW FLYER ORION BUS INDUSTRIES OTTAWA TRUCK	
85344	W HENDRICKSON TRAILER SUSPENSION SYSTEMS WATSON & CHALIN MFG. INC.	Not Req'd.				85722	D 145090(2) ARVIN MERITOR FLYER INDUSTRIES GILLIG BROS. GMC TRUCK M.A.N. BUS MUNCIE RECLAMATION NEW FLYER VOLVO	
85345	W HENDRICKSON TRAILER SUSPENSION SYSTEMS MC NEILUS TRUCK & MAN. WATSON & CHALIN MFG. INC.	Not Req'd.						
85346	W 145090(2) NEW FLYER							
85347	W 145090(2) NEW FLYER SCANIA							
85351	N 145090(1) IC CORPORATION INTERNATIONAL (NAVISTAR)							
85376	W 401754(4) FORD STERLING TRUCK							
85377	W NOVA BUS	Not Req'd.						
85378	W NOVA BUS PREVOST	Not Req'd.						
85379	W 145054(1) PREVOST							
85380	W 145090(1) & 401754(2) PREVOST							
85382	W HENDRICKSON TRAILER SUSPENSION SYSTEMS WATSON & CHALIN MFG. INC.	Not Req'd.						
85700	W 401754(4) ABC BUS AM GENERAL ARVIN MERITOR CHEVROLET TRUCK (Also See GMC Truck) FLXIBLE BUS FLYER INDUSTRIES GMC TRUCK GREYHOUND BUS GRUMMAN BUS JAY MADSEN KENWORTH MOHAWK MOTOR COACH INDUSTRIES							

N = New, S = Superseded, X = Discontinued once inventory is gone

NUMERICAL LISTING LISTA NUMÉRICA LISTE NUMÉRIQUE

GABRIEL#	APPLICATION	MTG ACC PKG NO	GABRIEL#	APPLICATION	MTG ACC PKG NO	GABRIEL#	APPLICATION	MTG ACC PKG NO
85723	W	145075(1)	85739	W	Not Req'd.	85914	W	Not Req'd.
GILLIG BROS. MOTOR COACH INDUSTRIES MUNCIE RECLAMATION VOLVO			INTERNATIONAL (NAVISTAR) MACK MERITOR RAYDAN MANUFACTURING			BLUEBIRD SCHOOL BUS SAF HOLLAND		
85724	A	Not Req'd.	85740	W	145090(1) & 401754(2)	85916	W	Not Req'd.
FREIGHTLINER FREIGHTLINER CUSTOM CHASSIS STERLING TRUCK THOMAS SCHOOL BUS VOLVO WESTERN STAR			MAECO MOTOR COACH INDUSTRIES PREVOST			HENDRICKSON TRAILER SUSPENSION SYSTEMS HENDRICKSON TRUCK SUSPENSION SYSTEMS MC NEILUS TRUCK & MAN. SAF HOLLAND VOLVO		
85727	D	145176(2)	85745	N	145090(2)	85918	A	Not Req'd.
ABC BUS MOTOR COACH INDUSTRIES			ELDORADO NATIONAL			FREIGHTLINER FREIGHTLINER CUSTOM CHASSIS THOMAS SCHOOL BUS VOLVO		
85728	D	145176(2)	85746	N	145090(2)	85919	A	Not Req'd.
MOTOR COACH INDUSTRIES PREVOST			ELDORADO NATIONAL			BLUEBIRD SCHOOL BUS FREIGHTLINER FREIGHTLINER CUSTOM CHASSIS GREAT DANE TRAILER HENDRICKSON TRUCK SUSPENSION SYSTEMS MC NEILUS TRUCK & MAN. MERITOR WABASH NATIONAL WORKHORSE		
85729	D	145176(1) & 401754(2)	85900	B	145054(2)	85920	B	Not Req'd.
ABC BUS MOTOR COACH INDUSTRIES ORION BUS INDUSTRIES PREVOST UNIVERSAL COACH			COACHMEN RV FLEETWOOD RV FOREST RIVER INC FREIGHTLINER CUSTOM CHASSIS GULF STREAM COACH ITASCA KENWORTH KING OF THE ROAD MANDALAY COACH NEWMAR CORP PETERBILT THOR MOTOR COACH VOLVO WINNEBAGO			FREIGHTLINER STERLING TRUCK		
85730	X	401754(4)	85901	C	401754(4)	85921	W	145054(1)
FLXIBLE BUS VOLVO			FREIGHTLINER KENWORTH PETERBILT RIDEWELL CORPORATION			FREIGHTLINER		
85731	X	145054(1) & 401754(2)	85902	D	145054(2)	85923	C	Not Req'd.
FLXIBLE BUS			KENWORTH PETERBILT			INTERNATIONAL (NAVISTAR)		
85732	W	145116(2)	85903	W	Not Req'd.	85924	B	Not Req'd.
ABC BUS NEW FLYER ORION BUS INDUSTRIES			HENDRICKSON TRUCK SUSPENSION SYSTEMS			INTERNATIONAL (NAVISTAR)		
85733	W	145089-000(1)	85904	W	Not Req'd.	85925	W	Not Req'd.
ABC BUS CHEVROLET TRUCK (Also See GMC Truck) EAGLE MOTOR COACH FLXIBLE BUS GMC TRUCK MOHAWK MOTOR COACH INDUSTRIES NOVA BUS TRANSPORTATION MFG. CORP VOLVO			FREIGHTLINER CUSTOM CHASSIS HENDRICKSON TRUCK SUSPENSION SYSTEMS LINK MANUFACTURING LTD. STERLING TRUCK			INTERNATIONAL (NAVISTAR)		
85734	W	401754(4)	85905	X	401754(2)	85926	C	Not Req'd.
BLUEBIRD SCHOOL BUS CHEVROLET TRUCK (Also See GMC Truck) CROWN COACH FLXIBLE BUS GILLIG BROS. GMC TRUCK INTERNATIONAL (NAVISTAR) LINK MANUFACTURING LTD. OSHKOSH MOTORS RIDEWELL CORPORATION SAF HOLLAND VOLVO			SAF HOLLAND			FORD IC CORPORATION INTERNATIONAL (NAVISTAR) STERLING TRUCK		
85735	W	401754(4)	85906	W	Not Req'd.	85927	W	Not Req'd.
ABC BUS CHEVROLET TRUCK (Also See GMC Truck) EAGLE MOTOR COACH GMC TRUCK GREYHOUND BUS MOTOR COACH INDUSTRIES PACIFIC TRUCK & TRAILER PREVOST TRANSPORTATION MFG. CORP VOLVO WESTERN UNIT "STABILAIRE" SUSPENSION			FORD KENWORTH MACK MC NEILUS TRUCK & MAN. PETERBILT SAF HOLLAND STERLING TRUCK VOLVO WESTERN STAR			FORD INTERNATIONAL (NAVISTAR)		
85736	W	401754(4)	85907	X	Not Req'd.	85928	D	Not Req'd.
BLUEBIRD SCHOOL BUS FLXIBLE BUS MOHAWK PREVOST RIDEWELL CORPORATION THOMAS SCHOOL BUS VOLVO			SAF HOLLAND			FORD INTERNATIONAL (NAVISTAR)		
85737	W	Not Req'd.	85908	W	Not Req'd.	85929	W	Not Req'd.
MERITOR SUSPENSYS			SAF HOLLAND			INTERNATIONAL (NAVISTAR)		
85738	B	Not Req'd.	85909	D	Not Req'd.	85930	W	Not Req'd.
EAST MANUFACTURING CORP. HENDRICKSON TRAILER SUSPENSION SYSTEMS MC NEILUS TRUCK & MAN. REYCO SUSPENSION TUTHILL TECHNOLOGIES UTILITY TRAILER MANUFACTURING COMPANY			FORD HENDRICKSON TRUCK SUSPENSION SYSTEMS KENWORTH MACK MC NEILUS TRUCK & MAN. ROADMASTER (MONACO) SAF HOLLAND			INTERNATIONAL (NAVISTAR)		
			85910	W	Not Req'd.	85931	A	Not Req'd.
			BLUEBIRD SCHOOL BUS FREIGHTLINER KENWORTH PETERBILT ROADMASTER (MONACO) SAF HOLLAND			INTERNATIONAL (NAVISTAR)		
			85911	W	Not Req'd.	85932	C	Not Req'd.
			HENDRICKSON TRAILER SUSPENSION SYSTEMS SAF HOLLAND UTILITY TRAILER MANUFACTURING COMPANY			FREIGHTLINER HENDRICKSON TRUCK SUSPENSION SYSTEMS MC NEILUS TRUCK & MAN. STERLING TRUCK WESTERN STAR		
			85912	X	401754(2)	85933	B	Not Req'd.
			SAF HOLLAND			HENDRICKSON TRUCK SUSPENSION SYSTEMS MACK MC NEILUS TRUCK & MAN. VOLVO		
			85913	X	401754(2)	85934	A	Not Req'd.
			RED LION TRAILER SAF HOLLAND			MAECO RIDEWELL CORPORATION WATSON & CHALIN MFG. INC.		

N = New, X = Discontinued once inventory is gone

**NUMERICAL LISTING
LISTA NUMÉRICA
LISTE NUMÉRIQUE**

GABRIEL#	APPLICATION	MTG ACC PKG NO	GABRIEL#	APPLICATION	MTG ACC PKG NO	GABRIEL#	APPLICATION	MTG ACC PKG NO
85938	B TUTHILL TECHNOLOGIES WATSON & CHALIN MFG. INC.	Not Req'd.	85976	W MC NEILUS TRUCK & MAN. VOLVO WESTERN STAR	Not Req'd.	695406	W ARVIN MERITOR VAN HOOL	145090(2)
85939	D ARVIN MERITOR HENDRICKSON TRAILER SUSPENSION SYSTEMS TIMBREN INDUSTRIES UTILITY TRAILER MANUFACTURING COMPANY WATSON & CHALIN MFG. INC.	Not Req'd.	85977	W HENDRICKSON TRUCK SUSPENSION SYSTEMS MC NEILUS TRUCK & MAN.	145128(1)	GasSLX Applications		
85953	W INTERNATIONAL (NAVISTAR)	Not Req'd.	85978	D HENDRICKSON TRUCK SUSPENSION SYSTEMS MACK VOLVO	Not Req'd.	89401	W FORD MAECO STERLING TRUCK VOLVO	140149(1)
85954	A INTERNATIONAL (NAVISTAR)	Not Req'd.	85979	W HENDRICKSON TRUCK SUSPENSION SYSTEMS MC NEILUS TRUCK & MAN. WESTERN STAR	Not Req'd.	89402	W BLUEBIRD SCHOOL BUS FORD STERLING TRUCK VOLVO	140149(1)
85955	W HENDRICKSON TRUCK SUSPENSION SYSTEMS INTERNATIONAL (NAVISTAR)	Not Req'd.	85980	W HENDRICKSON TRUCK SUSPENSION SYSTEMS MC NEILUS TRUCK & MAN.	Not Req'd.	89403	S FORD	140149(1)
85956	D FREIGHTLINER STERLING TRUCK VOLVO WESTERN STAR	Not Req'd.	85984	W FREIGHTLINER	Not Req'd.	89405	W BLUEBIRD SCHOOL BUS FORD GILLIG BROS. HENDRICKSON TRUCK SUSPENSION SYSTEMS INTERNATIONAL (NAVISTAR) KENWORTH MACK MAECO MARMON MC NEILUS TRUCK & MAN. PETERBILT REYCO SUSPENSION SAF HOLLAND TUTHILL TECHNOLOGIES VOLVO WATSON & CHALIN MFG. INC.	Not Req'd.
85957	C INTERNATIONAL (NAVISTAR) STERLING TRUCK	Not Req'd.	85985	W KENWORTH PETERBILT	145089-200(1)	89406	W ALLCO TRAILER AUTOCAR CHEVROLET TRUCK (Also See GMC Truck) COUNTRY COACH FORD FREIGHTLINER FRUEHAUF GILLIG BROS. GMC TRUCK GREAT DANE TRAILER HENDRICKSON TRUCK SUSPENSION SYSTEMS ISUZU KENWORTH LODAL, INC. MACK MAECO MARMON MC NEILUS TRUCK & MAN. OSHKOSH MOTORS PETERBILT REYCO SUSPENSION SAF HOLLAND TUTHILL TECHNOLOGIES VOLVO WESTERN STAR	Not Req'd.
85958	A FREIGHTLINER WESTERN STAR	Not Req'd.	85986	N HENDRICKSON TRUCK SUSPENSION SYSTEMS IC CORPORATION	Not Req'd.	89407	W ADVANCE MIXER BENSON TRUCK BODIES INC. BLUEBIRD SCHOOL BUS BROCKWAY SCHOOL BUS CHANCE BUS CHEVROLET TRUCK (Also See GMC Truck) DURA SUSPENSION EAST MANUFACTURING CORP. FORD GILLIG BROS. GMC TRUCK GREAT DANE TRAILER HARDEE MFG HENDRICKSON TRUCK SUSPENSION SYSTEMS HIGHWAY PRODUCT INTERNATIONAL (NAVISTAR) KENWORTH MACK MAECO MC NEILUS TRUCK & MAN. MOHAWK NATIONAL COACH CORP OSHKOSH MOTORS PETERBILT REYCO SUSPENSION RIDEWELL CORPORATION SAF HOLLAND STERLING TRUCK TRAILMOBILE CANADA CORP. TUTHILL TECHNOLOGIES TWIN COACH VOLVO	Not Req'd.
85959	B BLUEBIRD SCHOOL BUS FREIGHTLINER FREIGHTLINER CUSTOM CHASSIS HENDRICKSON TRUCK SUSPENSION SYSTEMS KENWORTH MC NEILUS TRUCK & MAN. PETERBILT SPARTAN MOTORS STERLING TRUCK	Not Req'd.	85988	N KENWORTH PETERBILT	145099(1)			
85961	W HENDRICKSON TRUCK SUSPENSION SYSTEMS	Not Req'd.	85989	N KENWORTH PETERBILT	Not Req'd.			
85962	W HENDRICKSON TRUCK SUSPENSION SYSTEMS MC NEILUS TRUCK & MAN.	Not Req'd.	85994	N INTERNATIONAL (NAVISTAR)	Not Req'd.			
85963	W INTERNATIONAL (NAVISTAR)	Not Req'd.	85995	N INTERNATIONAL (NAVISTAR)	Not Req'd.			
85964	W INTERNATIONAL (NAVISTAR)	Not Req'd.	85998	N INTERNATIONAL (NAVISTAR)	Not Req'd.			
85965	W HENDRICKSON TRUCK SUSPENSION SYSTEMS KENWORTH MC NEILUS TRUCK & MAN.	Not Req'd.	85999	N INTERNATIONAL (NAVISTAR)	Not Req'd.			
85966	W HENDRICKSON TRUCK SUSPENSION SYSTEMS KENWORTH MC NEILUS TRUCK & MAN.	Not Req'd.	86200	W MERITOR	Not Req'd.			
85967	W AUTOCAR HENDRICKSON TRUCK SUSPENSION SYSTEMS KENWORTH MC NEILUS TRUCK & MAN.	Not Req'd.	86201	W MERITOR	Not Req'd.			
85968	W GILLIG BROS. SAF HOLLAND	401754(4)	86202	W MERITOR	Not Req'd.			
85969	W INTERNATIONAL (NAVISTAR)	Not Req'd.	86203	W MERITOR	Not Req'd.			
85970	W MOTOR COACH INDUSTRIES	145089-000(1)	87015	W ARVIN MERITOR EAST MANUFACTURING CORP. MERITOR	Not Req'd.			
85971	W BLUEBIRD SCHOOL BUS	Not Req'd.	87016	W NEW FLYER ORION BUS INDUSTRIES	145116(1) & 145090(1)			
85972	W MACK	Not Req'd.	87017	W BLUEBIRD SCHOOL BUS OPTIMA BUS CORP RIDEWELL CORPORATION	Not Req'd.			
85974	W SAF HOLLAND	Not Req'd.	87018	W HENDRICKSON TRAILER SUSPENSION SYSTEMS	Not Req'd.			
85975	W BLUEBIRD SCHOOL BUS REYCO SUSPENSION SAF HOLLAND	Not Req'd.	87019	W NOVA BUS	Not Req'd.			
85976	W BLUEBIRD SCHOOL BUS HENDRICKSON TRUCK SUSPENSION SYSTEMS INTERNATIONAL (NAVISTAR)	Not Req'd.	89402	W VOLVO	140149(1)			
			89414	W MAECO	Not Req'd.			
			89440	W MAECO	Not Req'd.			
			89447	W MUNCIE RECLAMATION	141108(1)			
			646155	A VOLVO	Not Req'd.			
			695406	W ABC BUS	145090(2)			

N = New, S = Superseded

NUMERICAL LISTING LISTA NUMÉRICA LISTE NUMÉRIQUE

GABRIEL#	APPLICATION	MTG ACC PKG NO	GABRIEL#	APPLICATION	MTG ACC PKG NO	GABRIEL#	APPLICATION	MTG ACC PKG NO
89407	W WABASH NATIONAL WESTERN STAR	Not Req'd.	89418	W AUTOCAR INTERNATIONAL (NAVISTAR) VOLVO	145054(2)	89424	C MACK PETERBILT VOLVO	141247(1)
89408	A KENWORTH PETERBILT VOLVO	145080(2)	89419	W CHEVROLET TRUCK (Also See GMC Truck) FREIGHTLINER FRUEHAUF GMC TRUCK GRANNING SUSPENSION HOBBS TRAILERS INTERNATIONAL (NAVISTAR) MUNCIE RECLAMATION OSHKOSH MOTORS OSTERLUND TRUCK OTTAWA TRUCK PIERCE MANUFACTURING INC. REYCO SUSPENSION SAF HOLLAND SEAGRAVE FIRE APPARATUS LLC TUTHILL TECHNOLOGIES VOLVO WABASH NATIONAL WATSON & CHALIN MFG. INC. WESTERN UNIT "STABILAIRE" SUSPENSION	401754(4)	89425	W AUTOCAR CHALMERS SUSPENSION EAGLE MOTOR COACH FORD KENWORTH MAECO PETERBILT STERLING TRUCK VOLVO	401754(4)
89409	W FORD KENWORTH OSHKOSH MOTORS PETERBILT PIERCE MANUFACTURING INC. VOLVO	140149(1)	89420	W AM GENERAL CHEVROLET TRUCK (Also See GMC Truck) CRANE CARRIER FORD FREIGHTLINER FWD TRUCK GILLIG BROS. GMC TRUCK KENWORTH MACK MAECO MOTOR COACH INDUSTRIES PETERBILT RIDEWELL CORPORATION VOLVO	401754(4)	89426	D INTERNATIONAL (NAVISTAR) MACK MAECO OSHKOSH MOTORS PIERCE MANUFACTURING INC. VOLVO	145090(1)
89410	C FORD INTERNATIONAL (NAVISTAR) KENWORTH MACK MAECO PETERBILT REYCO SUSPENSION STERLING TRUCK TUTHILL TECHNOLOGIES VOLVO	401754(4)	89421	W ACF BRILL BUS Beck BROCKWAY SCHOOL BUS BUS & TRUCK CO. CHEVROLET TRUCK (Also See GMC Truck) CONTINENTAL TRAILWAYS-EAGLE INT'L CRANE CARRIER CROWN COACH Dina EAGLE MOTOR COACH FREIGHTLINER GMC TRUCK GREYHOUND BUS HAULMARK HENDRICKSON TRUCK SUSPENSION SYSTEMS HINO INTERNATIONAL (NAVISTAR) KENWORTH MACK MAECO MATSON SCHOOL BUS MCI MC NEILUS TRUCK & MAN. MITSUBISHI-FUSO MOHAWK MOTOR COACH INDUSTRIES NISSAN OISA ORION BUS INDUSTRIES OSHKOSH MOTORS OTTAWA TRUCK Peña PETERBILT PREVOST Ramirez Sultana THOMAS SCHOOL BUS TRANSPORTATION MFG. CORP VOLVO Volvo WESTERN STAR WESTERN UNIT "STABILAIRE" SUSPENSION	401754(4)	89427	C INTERNATIONAL (NAVISTAR) KENWORTH MACK PACCAR PETERBILT VOLVO	145099(1)
89411	D INTERNATIONAL (NAVISTAR) KENWORTH MARMON PETERBILT VOLVO	Not Req'd.	89422	W ACF BRILL BUS Beck BROCKWAY SCHOOL BUS BUS & TRUCK CO. CHEVROLET TRUCK (Also See GMC Truck) CONTINENTAL TRAILWAYS-EAGLE INT'L CRANE CARRIER CROWN COACH Dina EAGLE MOTOR COACH FREIGHTLINER GMC TRUCK GREYHOUND BUS HAULMARK HENDRICKSON TRUCK SUSPENSION SYSTEMS HINO INTERNATIONAL (NAVISTAR) KENWORTH MACK MAECO MATSON SCHOOL BUS MCI MC NEILUS TRUCK & MAN. MITSUBISHI-FUSO MOHAWK MOTOR COACH INDUSTRIES NISSAN OISA ORION BUS INDUSTRIES OSHKOSH MOTORS OTTAWA TRUCK Peña PETERBILT PREVOST Ramirez Sultana THOMAS SCHOOL BUS TRANSPORTATION MFG. CORP VOLVO Volvo WESTERN STAR WESTERN UNIT "STABILAIRE" SUSPENSION	401754(4)	89428	W FREIGHTLINER INTERNATIONAL (NAVISTAR) KENWORTH MACK PETERBILT VOLVO	145089-000(1)
89412	X FREIGHTLINER KENWORTH MACK PETERBILT REYCO SUSPENSION SPARTAN MOTORS TUTHILL TECHNOLOGIES VOLVO	401754(4)	89423	D INTERNATIONAL (NAVISTAR) KENWORTH MACK OTTAWA TRUCK PETERBILT VOLVO	141108(1)	89429	C FREIGHTLINER KENWORTH MAECO PETERBILT VOLVO	401754(4)
89413	D ARVIN MERITOR BLUEBIRD SCHOOL BUS BROCKWAY SCHOOL BUS CHANCE COACH CHEVROLET TRUCK (Also See GMC Truck) FORD GMC TRUCK INTERNATIONAL (NAVISTAR) ISUZU KENWORTH PETERBILT VOLVO	145080(2)	89424	C FLXIBLE BUS INTERNATIONAL (NAVISTAR) KENWORTH LEYLAND TRUCK	141247(1)	89430	C AUTOCAR BLUEBIRD SCHOOL BUS BOYDSTUN EQUIPMENT MANUFACTURING CHEVROLET TRUCK (Also See GMC Truck) EAST MANUFACTURING CORP. FREIGHTLINER FREIGHTLINER CUSTOM CHASSIS GMC TRUCK HENDRICKSON TRAILER SUSPENSION SYSTEMS HENDRICKSON TRUCK SUSPENSION SYSTEMS HINO INTERNATIONAL (NAVISTAR) MACK MAECO MERCEDES BENZ OSHKOSH MOTORS REYCO SUSPENSION RIDEWELL CORPORATION SAF HOLLAND TUTHILL TECHNOLOGIES VOLVO WABASH NATIONAL WATSON & CHALIN MFG. INC.	Not Req'd.
89414	W BLUEBIRD SCHOOL BUS CHEVROLET TRUCK (Also See GMC Truck) COUNTRY COACH FORD GMC TRUCK HENDRICKSON TRAILER SUSPENSION SYSTEMS HENDRICKSON TRUCK SUSPENSION SYSTEMS INTERNATIONAL (NAVISTAR) KENWORTH MACK MAECO MC NEILUS TRUCK & MAN. PETERBILT REYCO SUSPENSION SAF HOLLAND SPARTAN MOTORS STERLING TRUCK TRAILMOBILE CANADA CORP. TUTHILL TECHNOLOGIES VOLVO WESTERN STAR	Not Req'd.	89431	W BLUEBIRD SCHOOL BUS FREIGHTLINER FREIGHTLINER CUSTOM CHASSIS INTERNATIONAL (NAVISTAR) OSHKOSH MOTORS PIERCE MANUFACTURING INC. THOMAS SCHOOL BUS VOLVO	Not Req'd.	89432	W KENWORTH MAECO VOLVO	Not Req'd.
89415	W INTERNATIONAL (NAVISTAR) KENWORTH MACK PETERBILT VOLVO	140149(1)	89432	W AUTOCAR VOLVO	140149(1)	89433	W FORD KENWORTH PETERBILT STERLING TRUCK VOLVO	140149(1)
89416	X AUTOCAR INTERNATIONAL (NAVISTAR) MACK VOLVO	140149(1)	89434	A ARVIN MERITOR BENSON TRUCK BODIES INC.	Not Req'd.	89435	W FORD KENWORTH PETERBILT STERLING TRUCK VOLVO	140149(1)
89417	W AUTOCAR GMC TRUCK VOLVO	145054(1)	89435	W FORD KENWORTH PETERBILT STERLING TRUCK VOLVO	140149(1)	89436	A ARVIN MERITOR BENSON TRUCK BODIES INC.	Not Req'd.

**NUMERICAL LISTING
LISTA NUMÉRICA
LISTE NUMÉRIQUE**

GABRIEL#	APPLICATION	MTG ACC PKG NO	GABRIEL#	APPLICATION	MTG ACC PKG NO	GABRIEL#	APPLICATION	MTG ACC PKG NO
89436	A	Not Req'd.	89448	D	Not Req'd.			
CHANCE BUS CHEVROLET TRUCK (Also See GMC Truck) DURA SUSPENSION EAST MANUFACTURING CORP. FREIGHTLINER FRUEHAUF GMC TRUCK GREAT DANE TRAILER HENDRICKSON TRAILER SUSPENSION SYSTEMS HIGHWAY PRODUCT HUTCHENS SUSPENSION INGERSOLL AXLES KENWORTH MACK MC NEILUS TRUCK & MAN. MOHAWK ORION BUS INDUSTRIES PAGE SUSPENSION PETERBILT REYCO SUSPENSION RIDEWELL CORPORATION SAF HOLLAND STOUGHTON TRAILERS INC. THOMAS SCHOOL BUS TRAILMOBILE CANADA CORP. TUTHILL TECHNOLOGIES TWIN COACH UTILITY TRAILER MANUFACTURING COMPANY VOLVO WABASH NATIONAL WATSON & CHALIN MFG. INC.			MACK VOLVO					
89437	W	Not Req'd.	89449	B	Not Req'd.			
EAST MANUFACTURING CORP. HENDRICKSON TRAILER SUSPENSION SYSTEMS THOMAS SCHOOL BUS			FREIGHTLINER FREIGHTLINER CUSTOM CHASSIS THOMAS SCHOOL BUS VOLVO					
89438	W	145080(2)	89450	W	Not Req'd.			
FORD STERLING TRUCK			MACK VOLVO					
89439	W	145080(2)	89451	B	Not Req'd.			
FORD STERLING TRUCK			KENWORTH PETERBILT					
89440	W	Not Req'd.	89453	W	Not Req'd.			
BLUEBIRD SCHOOL BUS CHEVROLET TRUCK (Also See GMC Truck) EAST MANUFACTURING CORP. FORD FRUEHAUF GMC TRUCK HENDRICKSON TRAILER SUSPENSION SYSTEMS HENDRICKSON TRUCK SUSPENSION SYSTEMS INTERNATIONAL (NAVISTAR) KENWORTH MAECO OSHKOSH MOTORS PACIFIC TRUCK & TRAILER PETERBILT PIERCE MANUFACTURING INC. REYCO SUSPENSION SAF HOLLAND STERLING TRUCK TUTHILL TECHNOLOGIES VOLVO WABASH NATIONAL			FREIGHTLINER HENDRICKSON TRUCK SUSPENSION SYSTEMS MC NEILUS TRUCK & MAN. STERLING TRUCK WESTERN STAR					
89441	W	145054(1)	89454	W	Not Req'd.			
FORD KENWORTH SAF HOLLAND			HENDRICKSON TRUCK SUSPENSION SYSTEMS MACK MC NEILUS TRUCK & MAN. VOLVO					
89442	W	145126(2)	89455	B	141108(1)			
WESTERN STAR			ARVIN MERITOR KENWORTH PETERBILT					
89443	B	Not Req'd.	89456	D	145089-200(1)			
FREIGHTLINER FREIGHTLINER CUSTOM CHASSIS STERLING TRUCK THOMAS SCHOOL BUS VOLVO WESTERN STAR			KENWORTH PETERBILT					
89446	W	TR0027(4)	89457	W	Not Req'd.			
FORD INTERNATIONAL (NAVISTAR) STERLING TRUCK VOLVO			INTERNATIONAL (NAVISTAR)					
89447	W	141108(1)	89458	C	Not Req'd.			
BLUEBIRD SCHOOL BUS FLXIBLE BUS IC CORPORATION INTERNATIONAL (NAVISTAR) MITSUBISHI-FUSO MUNCIE RECLAMATION NEOPLAN BUS VOLVO			INTERNATIONAL (NAVISTAR)					
			89459	C	401754(2)			
			KENWORTH PETERBILT					
			89460	W	Not Req'd.			
			KENWORTH PETERBILT					
			89461	W	Not Req'd.			
			GILLIG BROS.					

COMPETITIVE & O.E.M. INTERCHANGE LIST
Lista de Intercambios contra Competidores y Equipo Original.
Liste d'interchange de produits compétitifs & d'équipement original (OEM)

ABC BUS

O.E.M #	Gabriel	Upgrade	O.E.M #	Gabriel	Upgrade	O.E.M #	Gabriel	Upgrade	O.E.M #	Gabriel	Upgrade
050134513	85732		12L-5-114	85727		6243-13790	85708		90-2291	695406	
10685703	695406		12L-5-72	85709		6243-14040	85708				
12B-5-1	85735		12L-5-88	85729		624314570	695406				
12J-5-10	85733		3166657	85700		680323	85700				

ACF BRILL BUS

O.E.M #	Gabriel	Upgrade	O.E.M #	Gabriel	Upgrade	O.E.M #	Gabriel	Upgrade	O.E.M #	Gabriel	Upgrade
610513	85307		641521	85308	89422	659129	85303	89422	661733	83225	
631237	85308	89422	649648	85308	89422	661732	83215		995891	85307	

ADVANCE MIXER

O.E.M #	Gabriel	Upgrade	O.E.M #	Gabriel	Upgrade	O.E.M #	Gabriel	Upgrade	O.E.M #	Gabriel	Upgrade
12111 ADV	646155		13883	85334		14626 ADV	83209		680087	85334	
13424 ADV	83207	89407	13883 ADV	85334		23458 ADV	83112				

ALLCO TRAILER

O.E.M #	Gabriel	Upgrade	O.E.M #	Gabriel	Upgrade	O.E.M #	Gabriel	Upgrade	O.E.M #	Gabriel	Upgrade
727602	83122	89406									

AM GENERAL

O.E.M #	Gabriel	Upgrade	O.E.M #	Gabriel	Upgrade	O.E.M #	Gabriel	Upgrade	O.E.M #	Gabriel	Upgrade
3166657	85700		5957136	85700		5979484	85302	89420			
4975501	85700		5969438	85700		5979574	85700				
5565748	85700		5978712	85700		5982537	85700				

ARALMEX

Aralmex	Gabriel	Upgrade	Aralmex	Gabriel	Upgrade	Aralmex	Gabriel	Upgrade	Aralmex	Gabriel	Upgrade
2AMG037	G63375		3AMG007	G63357		3AMG023	G63421		3AMG031	G63360	
3AMG001	G63355		3AMG008	G63500		3AMG026	G63455		3AMG032	G63502	
3AMG004	G63306		3AMG009	G63406		3AMG027	G63426		3AMG033	G63614	
3AMG005	G63359		3AMG021	G63409		3AMG029	G63488		3AMG034	G63608	
3AMG006	G63377		3AMG022	G63454		3AMG030	G63818		3AMG035	G63607	

ARVIN MERITOR

O.E.M #	Gabriel	Upgrade	O.E.M #	Gabriel	Upgrade	O.E.M #	Gabriel	Upgrade	O.E.M #	Gabriel	Upgrade
085009	85009		665760	85045		671707	85052		695172	85707	
085014	85014		665769	85052		680102	85712		695214	85722	
085321	85321		665804	85939		680322	85704		695406	695406	
654907	85000	89436	671091	85069	89455	680518	85700		7805-N-1002	85329	
659222	83171		671092	85012	89413	680584	85938		7805-S-1007	85329	
665724	85000	89436	671507	87015		680671	85708				

AUTOCAR

O.E.M #	Gabriel	Upgrade	O.E.M #	Gabriel	Upgrade	O.E.M #	Gabriel	Upgrade	O.E.M #	Gabriel	Upgrade
03-1106460	85005	89430	37301-3201	85027	89418	60680-004	83143		8026658	85046	89434
1011839	83216		37301-3202	85026	89417	60680-005	83142		8071524	85024	89416
28CFG-910	83216		60657-003	85072		660186	83216		849246	83216	
28R010	83216		60665-011	85967		800670	85060				
35901-3201	85024	89416	60680-003	83112		800781	85314	89425			

BATCO

Batco	Gabriel	Upgrade	Batco	Gabriel	Upgrade	Batco	Gabriel	Upgrade	Batco	Gabriel	Upgrade
1083203	83203	89436	1083225	83225		1085005	85005	89430	1085311	85311	89424
1083204	83204		1083310	83221		1085007	85007	89412	1087001	85734	
1083207	83207	89407	1083317	83317		1085300	85300	89419	1087004	85735	
1083209	83209	89414	1085003	85003	89411	1085305	85305		1087006	85736	

BECK BUS

O.E.M #	Gabriel	Upgrade	O.E.M #	Gabriel	Upgrade	O.E.M #	Gabriel	Upgrade	O.E.M #	Gabriel	Upgrade
14QK-140	85304		14QK-2102	85304							

BENSON TRUCK BODIES INC.

O.E.M #	Gabriel	Upgrade	O.E.M #	Gabriel	Upgrade	O.E.M #	Gabriel	Upgrade	O.E.M #	Gabriel	Upgrade
90044089	83124	89407	A-20002	85000	89436						

Important Note: Competitive Interchanges are to be used for stocking purposes only. Where multiple crosses are identified, please reference the applications section of this catalog. / **Remarque importante:** Les interchanges concurrentiels ne s'utilisent qu'aux fins de stocks. Dans le cas de références multiples, consulter la section des applications du catalogue. / **Nota importante:** Dans le cas de références multiples, consulter la section des applications du catalogue. / **Nota importante:** Se pueden usar intercambios competitivos para propósitos de almacenamiento solamente. Cuando se identifican intercambios múltiples, consulte la sección de aplicaciones de este catálogo.

COMPETITIVE & O.E.M. INTERCHANGE LIST
Lista de Intercambios contra Competidores y Equipo Original.
Liste d'interchange de produits compétitifs & d'équipement original (OEM)

BERING TRUCK CORP.

O.E.M #	Gabriel	Upgrade	O.E.M #	Gabriel	Upgrade	O.E.M #	Gabriel	Upgrade	O.E.M #	Gabriel	Upgrade
47902-24	83137										

BILSTEIN

Bilstein	Gabriel	Upgrade	Bilstein	Gabriel	Upgrade	Bilstein	Gabriel	Upgrade	Bilstein	Gabriel	Upgrade
B46-1594	85013	89414	B46-1725	85029		B46-2151	85007	89412			

BLUEBIRD SCHOOL BUS

O.E.M #	Gabriel	Upgrade	O.E.M #	Gabriel	Upgrade	O.E.M #	Gabriel	Upgrade	O.E.M #	Gabriel	Upgrade
00085991	85006		1668730	85013	89414	58913-007	85959		7805-N-1002	85329	
00119797	85959		1707405	85005		58913-007L	85959		7805-S-1007	85329	
00119798	85106		1722214	85030	89440	58913-008	85959		87001-01A	85734	
0014605	85036	89405	1722222	85013	89414	58913-009	85959		8C24-18045-DA	83177	
0014985	83137		1746163	85006		58913-010	85106		8C24-18080-DB	83178	
0015222	85919		1750793	85712		58913-011	85959		8C2Z-18124-D	83177	
0020326	85976		1962422	85304		59057-001	83137		8C2Z-18125-D	83178	
0040015	85919		1962430	83207	89407	59057-002	85036	89405	90-1813	85712	
0055008	85959		2021459	85012	89413	59483-000	85919		90-1951-SP1	85734	
0055017	85959		23106-01	85975		60665-005	85919		90-1968	85712	
0075916	85086		300-0614966	85307		609180	85304		90-1968-SP1	85712	
0085990	85959		300-0614974	85304		60998-001	85006		90-2610 SP1	87017	
0088035	85090		300-0823047	85736		60998-002	85919		90044448	85051	
0106303	85106		300-0823054	85304		60998-003	85006		90044915	83127	
0110808	83124	89407	300-09612284	85734		614958	85307		90045050	85914	
0523047	85736		300-1316546	85006		614966	85307		90045083	85910	
0823054	85304		300-1317767	85029		614974	85304		A-4890	85712	
1004167	85712		303-1350628	85712		65992-003	85959		AMS65109	85058	89431
1217934	85304		305-0961284	85734		65992-004	85106		AMS65110	85005	89430
1260008	87017		471700000428	85006		671933	85919		AMS65119	85029	
1316546	85006		471700000456	85959		680102	85712		ASH-1136	83178	
1317767	85029		471700000464	85090		680155	85712		ASH-1154	83177	
1526417	85052		471700002919	85106		680667		89447	AT-163G	83177	
1658525	85971		471700131545	85006		680783	85304		AT-164G	83178	
1658533	85010		4759272		89447	70317		89402			
1667831	85029		4760958	85086		70397	85006				
1668722	85030	89440	481700131438	85919		7805-M-1001	85919				

BOGE

Boge	Gabriel	Upgrade	Boge	Gabriel	Upgrade	Boge	Gabriel	Upgrade	Boge	Gabriel	Upgrade
40-A85-0	85708										

BOYDSTUN EQUIPMENT MANUFACTURING

O.E.M #	Gabriel	Upgrade	O.E.M #	Gabriel	Upgrade	O.E.M #	Gabriel	Upgrade	O.E.M #	Gabriel	Upgrade
1253069B000	85005	89430									

BROCKWAY SCHOOL BUS

O.E.M #	Gabriel	Upgrade	O.E.M #	Gabriel	Upgrade	O.E.M #	Gabriel	Upgrade	O.E.M #	Gabriel	Upgrade
14QK-281P10	85305		152398	85304		515231	85303	89422			
14QK-282P1	83216		152412	83215		530873	83207	89407			
14QK-282P3	83216		508657	85307		532397	85307				

BUILT RITE

O.E.M #	Gabriel	Upgrade	O.E.M #	Gabriel	Upgrade	O.E.M #	Gabriel	Upgrade	O.E.M #	Gabriel	Upgrade
318-06-100	85006										

BUS & TRUCK CO.

O.E.M #	Gabriel	Upgrade	O.E.M #	Gabriel	Upgrade	O.E.M #	Gabriel	Upgrade	O.E.M #	Gabriel	Upgrade
0100-905	85307		680091	85303	89422	70039	85303	89422	70041	85305	

CARPENTER BUS

O.E.M #	Gabriel	Upgrade	O.E.M #	Gabriel	Upgrade	O.E.M #	Gabriel	Upgrade	O.E.M #	Gabriel	Upgrade
0272-SS5	85712		63-0001	85713							

CASCADE TRAILER

O.E.M #	Gabriel	Upgrade	O.E.M #	Gabriel	Upgrade	O.E.M #	Gabriel	Upgrade	O.E.M #	Gabriel	Upgrade
120-1	83125										

Important Note: Competitive Interchanges are to be used for stocking purposes only. Where multiple crosses are identified, please reference the applications section of this catalog. / **Remarque importante:** Les interchanges concurrentiels ne s'utilisent qu'aux fins de stocks. Dans le cas de références multiples, consulter la section des applications du catalogue. / **Nota importante:** Dans le cas de références multiples, consulter la section des applications du catalogue. / **Nota importante:** Se pueden usar intercambios competitivos para propósitos de almacenamiento solamente. Cuando se identifican intercambios múltiples, consulte la sección de aplicaciones de este catálogo.

COMPETITIVE & O.E.M. INTERCHANGE LIST

Lista de Intercambios contra Competidores y Equipo Original.

Liste d'interchange de produits compétitifs & d'équipement original (OEM)

CHEVROLET TRUCK (Also See GMC Truck)... cont'd

O.E.M #	Gabriel	Upgrade	O.E.M #	Gabriel	Upgrade	O.E.M #	Gabriel	Upgrade	O.E.M #	Gabriel	Upgrade
5527606	85305		5549899	83207	89407	5552453	85301		88982684	83136	
5531027	85301		5549924	85700		5552456	85307		88982685	85342	
5531435	85307		5549925	85304		5552527	85735		88982686	85071	
5531436	85307		5552111	85304		5552552	85303	89422	88982687	85342	
5531437	85307		5552112	85307		5554184	85302	89420	88982688	85336	
5532026	85304		5552114	83216		5554589	85307		9-51630-647-1	83515	
5532425	83207	89407	5552205	83217		5554596	85303	89422	9-51630-666-0	85012	89413
5532433	83207	89407	5552206	83214		5554814	85302	89420	9-51630-666-2	85012	89413
5532675	85307		5552207	83217		5554959	83401		94033786	83114	
5534430	85303	89422	5552208	83217		5554995	85305		94051090	83114	
5534439	85304		5552209	83215		5559363	83203	89436	94057593	83114	
5534447	85303	89422	5552210	85308	89422	5585939	85307		94454987	83515	
5544060	85302	89420	5552244	85308	89422	684280	83209	89414	97-2210-00153	85701	
5544112	83216		5552285	83214		8-94057-593-0	83114		97-2210-00164	85708	
5544581	85302	89420	5552286	83217		8-94454-986-0	83515		97-2210-00170	85733	
5544716	85304		5552287	83217		8-94454-987-0	83515		97083027	83515	
5544717	85304		5552288	83217		8-97201-960-0	83515		97083029	83515	
5544812	83308		5552451	85308	89422	88963409	85336		97201960	83515	
5544818	85735		5552452	85303	89422	88982682	83136		L-12706	83155	

CHEVROLET TRUCK CAB SHOCKS

O.E.M #	Gabriel	Upgrade	O.E.M #	Gabriel	Upgrade	O.E.M #	Gabriel	Upgrade	O.E.M #	Gabriel	Upgrade
1202-0012	83023		1202-0022	83046		1202-0032	83016		1202-0054	83021	

CHRYSLER

O.E.M #	Gabriel	Upgrade	O.E.M #	Gabriel	Upgrade	O.E.M #	Gabriel	Upgrade	O.E.M #	Gabriel	Upgrade
2961043	G63183		3633744	G63183		3638112	G63183				

CLARK EQUIPMENT

O.E.M #	Gabriel	Upgrade	O.E.M #	Gabriel	Upgrade	O.E.M #	Gabriel	Upgrade	O.E.M #	Gabriel	Upgrade
355778	85315		5532675	85307		680042	85301				

CNH GLOBAL N V

O.E.M #	Gabriel	Upgrade	O.E.M #	Gabriel	Upgrade	O.E.M #	Gabriel	Upgrade	O.E.M #	Gabriel	Upgrade
87019546	83022		87268250	83021							

COACHMEN RV

O.E.M #	Gabriel	Upgrade	O.E.M #	Gabriel	Upgrade	O.E.M #	Gabriel	Upgrade	O.E.M #	Gabriel	Upgrade
141700131809	85029		16-16736-000	85029		16-16873-000	85029		16-18103-000	85900	
141700131810	83160		16-16737-000	83160		16-16874-000	83160		481700000493	85900	

COFAP

Cofap	Gabriel	Upgrade	Cofap	Gabriel	Upgrade	Cofap	Gabriel	Upgrade	Cofap	Gabriel	Upgrade
45011	85702		45094	85949		45238	85949		L-12476	85074	
45054	85301		45095	85948		45240	85981		L-12477	85073	
45056	85315		45096	85951		8482	85026	89417	L-12488	85073	
45058	85301		45117	85918	89449	ATG-046	G63457		L-12590	85074	
45058	85941		45137	85948		ATG-051	G63426		L-12601	85077	
45086	85949		45139C-Y	85901		ATG-081	G63502		L-12602	85076	
45087	85943		45160	85946		ATG-084	G63608		L-12687	83030	
45089	85940		45174	85947		ATG-085	G63607		L-12703	85071	
45089	85949		45189	85950		L-12039	85065		L-12706	83155	
45090	85942		45200	85941		L-12040	85073		L-12713	83136	
45091	85944		45235	85946		L-12151	85075		L-13092	85073	

CONDUMEX

Condumex	Gabriel	Upgrade	Condumex	Gabriel	Upgrade	Condumex	Gabriel	Upgrade	Condumex	Gabriel	Upgrade
43066	83309	89446	53010	83136		53041	85310	89423	53065	83136	
43136	83017		53018	83317		53042	83309		53066	83124	89407
43137	83009		53019	83456		53043	83215		53078	85940	
43138	83004		53038	85103		53059	85051		53079	85074	
43139	83021		53039	85006		53062	83009		53080	83015	
43145	83021		53040	85006		53063	83025		58012	85314	89425

Important Note: Competitive Interchanges are to be used for stocking purposes only. Where multiple crosses are identified, please reference the applications section of this catalog. / **Remarque importante:** Les interchanges concurrentiels ne s'utilisent qu'aux fins de stocks. Dans le cas de références multiples, consulter la section des applications du catalogue. / **Nota importante:** Dans le cas de références multiples, consulter la section des applications du catalogue. / **Nota importante:** Se pueden usar intercambios competitivos para propósitos de almacenamiento solamente. Cuando se identifican intercambios múltiples, consulte la sección de aplicaciones de este catálogo.

COMPETITIVE & O.E.M. INTERCHANGE LIST
Lista de Intercambios contra Competidores y Equipo Original.
Liste d'interchange de produits compétitifs & d'équipement original (OEM)

CONDUMEX... cont'd

Condumex	Gabriel	Upgrade	Condumex	Gabriel	Upgrade	Condumex	Gabriel	Upgrade	Condumex	Gabriel	Upgrade
58034	85013	89414	69515	83124	89407	69725	85918	89449	78009	85303	89422
58038	85001	89410	69669	83123	89405	69726	85319		78013	85323	89436
58040	85026	89417	69670	85051		69728	85055	89439	78015	85724	89443
58041	83456		69671	85006		69729	85314	89425	78016	85001	89410
58047	85381		69672	85043		69732	85300	89419	78020	85712	
58048	83137		69673	83209	89414	69741	85906		78023	85705	
58049	85323	89436	69680	83200		69743	85061	89450	78025	85009	
58050	85061	89450	69685	83136		69745	85058	89431	78026	85706	
58055	85003	89411	69687	83100		69746	83137		78027	85314	89425
58056	83137		69688	85302	89420	69747	85003		78030	85316	89426
58057	83456	89447	69705	83122	89406	69748	85001	89410	78034	85920	
58058	85031		69711	83207	89407	69750	85314	89425	78039	85311	
58059	85005		69712	85013	89414	69752	85316	89426	USA53085	83512	
58061	83122		69713	85046	89434	69753	85031		USA53086	83511	
58061	85916		69714	83215		78001	85314	89425	USA53087	83506	
58062	85096		69715	85000	89436	78002	85702		USA53088	83513	
58065	85949		69716	85024	89416	78003	85308	89422	USA53091	83508	
58067	85942		69717	85310	89423	78005	85310	89423	USA53092	83509	
69500	83122	89406	69720	85736		78007	85307				

CONTINENTAL TRAILWAYS-EAGLE INT'L

O.E.M #	Gabriel	Upgrade	O.E.M #	Gabriel	Upgrade	O.E.M #	Gabriel	Upgrade	O.E.M #	Gabriel	Upgrade
01-0100-020	85307		5394467	85305		6-05-5	85307		70039	85303	89422
01-0100-905	85303	89422	5532026	85304		680091	85303	89422	70041	85305	

COUNTRY COACH

O.E.M #	Gabriel	Upgrade	O.E.M #	Gabriel	Upgrade	O.E.M #	Gabriel	Upgrade	O.E.M #	Gabriel	Upgrade
89406		89406	89414		89414						

CRANE CARRIER

O.E.M #	Gabriel	Upgrade	O.E.M #	Gabriel	Upgrade	O.E.M #	Gabriel	Upgrade	O.E.M #	Gabriel	Upgrade
277A-1	85307		277A-13	85302	89420	277A-8	85303	89422	680088	85713	
277A-12	85304		277A-14	85304		277A-9	85307		680091	85303	89422

CROWN COACH

O.E.M #	Gabriel	Upgrade	O.E.M #	Gabriel	Upgrade	O.E.M #	Gabriel	Upgrade	O.E.M #	Gabriel	Upgrade
3188729	85303	89422	5532026	85304		5532036	85734				

CUNHA PRODUCTS OHD

O.E.M #	Gabriel	Upgrade	O.E.M #	Gabriel	Upgrade	O.E.M #	Gabriel	Upgrade	O.E.M #	Gabriel	Upgrade
CP-5222	85315										

DANA

O.E.M #	Gabriel	Upgrade	O.E.M #	Gabriel	Upgrade	O.E.M #	Gabriel	Upgrade	O.E.M #	Gabriel	Upgrade
SR1VJ100	85078										

DELCO

Delco	Gabriel	Upgrade	Delco	Gabriel	Upgrade	Delco	Gabriel	Upgrade	Delco	Gabriel	Upgrade
501-13	83318		507-24	85336		508-20	83207	89407	508-42	G63389	
501-74	83304		507-3	85307		508-21	83214		508-47	G63350	
501-75	83303		507-4	85303	89422	508-22	83217		508-47	G63377	
507-1	85304		507-5	85308	89422	508-23	83217		508-48	G63409	
507-10	85711		507-6	85314	89425	508-23	83225		508-48	G63427	
507-11	85308	89422	507-7	85301		508-24	83215		508-5	G63359	
507-12	85701		507-8	85301		508-26	83203	89436	508-5	G63360	
507-13	85704		507-9	85700		508-26	85030	89440	508-50	G63299	
507-15	85703		508-13	85012	89413	508-28	83207	89407	508-50	G63907	
507-16	85702		508-14	83216		508-29	85030	89440	508-52	G63405	
507-17	85304		508-14	85012	89413	508-3	83400		508-52	G63419	
507-18	85305		508-15	83216		508-30	85005	89430	508-52	G63492	
507-19	85700		508-16	83308	89435	508-35	G63306				
507-2	85302	89420	508-17	83312	89409	508-35	G63371				
507-22	85342		508-18	83309	89446	508-39	G63347				
507-23	85342		508-19	83314		508-42	G63353				

Important Note: Competitive Interchanges are to be used for stocking purposes only. Where multiple crosses are identified, please reference the applications section of this catalog. / **Remarque importante:** Les interchanges concurrentiels ne s'utilisent qu'aux fins de stocks. Dans le cas de références multiples, consulter la section des applications du catalogue. / **Nota importante:** Dans le cas de références multiples, consulter la section des applications du catalogue. / **Nota importante:** Se pueden usar intercambios competitivos para propósitos de almacenamiento solamente. Cuando se identifican intercambios múltiples, consulte la sección de aplicaciones de este catálogo.

COMPETITIVE & O.E.M. INTERCHANGE LIST

Lista de Intercambios contra Competidores y Equipo Original.

Liste d'interchange de produits compétitifs & d'équipement original (OEM)

DELCO... cont'd

Delco	Gabriel	Upgrade	Delco	Gabriel	Upgrade	Delco	Gabriel	Upgrade	Delco	Gabriel	Upgrade
508-56	G63605		508-71	83314		508-82	G63410		550-13	85005	89430
508-57	83123	89405	508-71	G63398		508-86	83136		550-73	83303	
508-59	G63183		508-72	G63386		508-87	85071		550-73	85005	89430
508-68	83209	89414	508-74	G63511		508-88	83153		550-74	83304	
508-68	85006		508-78	83400		508-89	83155		550-75	83303	
508-70	G63396		508-79	G63424		508-9	85000	89436	550-77	83221	
508-70	G63416		508-80	G63425		508-90	83136				

DEXTER AXLE

O.E.M #	Gabriel	Upgrade	O.E.M #	Gabriel	Upgrade	O.E.M #	Gabriel	Upgrade	O.E.M #	Gabriel	Upgrade
18165-01	85006										

DIAMOND T

O.E.M #	Gabriel	Upgrade	O.E.M #	Gabriel	Upgrade	O.E.M #	Gabriel	Upgrade	O.E.M #	Gabriel	Upgrade
5549925	85304										

DIAMOND-REO

O.E.M #	Gabriel	Upgrade	O.E.M #	Gabriel	Upgrade	O.E.M #	Gabriel	Upgrade	O.E.M #	Gabriel	Upgrade
220-55-1	83214		220-55-6	83214		220-55-8	83217				
220-55-2	85304		220-55-7	85304		220-S5-10	85712				

DINA BUS

O.E.M #	Gabriel	Upgrade	O.E.M #	Gabriel	Upgrade	O.E.M #	Gabriel	Upgrade	O.E.M #	Gabriel	Upgrade
1520030010	83317		39380353-6	85716		39390340-4	85716				
152E030030	85014		39390339-6	85307							

DODGE TRUCK

O.E.M #	Gabriel	Upgrade	O.E.M #	Gabriel	Upgrade	O.E.M #	Gabriel	Upgrade	O.E.M #	Gabriel	Upgrade
2516009	G63183		2961043	G63183		3633744	G63183		3638631	G63605	
2960707	G63183		3633643	G63183		3638112	G63183		4036892	G63605	

DUPLEX TRUCK

O.E.M #	Gabriel	Upgrade	O.E.M #	Gabriel	Upgrade	O.E.M #	Gabriel	Upgrade	O.E.M #	Gabriel	Upgrade
59024	83204		7604-3371	83204							

DURA SUSPENSION

O.E.M #	Gabriel	Upgrade	O.E.M #	Gabriel	Upgrade	O.E.M #	Gabriel	Upgrade	O.E.M #	Gabriel	Upgrade
1080099	83203	89436	59024	83204		665133	83203	89436	7604-3371	83204	
12866	83207	89407	59030	83203	89436	665267	85029		A-2212	85029	

EAGLE MOTOR COACH

O.E.M #	Gabriel	Upgrade	O.E.M #	Gabriel	Upgrade	O.E.M #	Gabriel	Upgrade	O.E.M #	Gabriel	Upgrade
01-0100-020	85307		101364	85305		5394467	85305		690060	85713	
01-0100-905	85303	89422	12B-5-1	85735		5532026	85304		70039	85303	89422
014-0100-905	85308	89422	12J-5-10	85733		6-05-5	85307		70041	85305	
0140100-905	85308	89422	154-0100-514	85314	89425	680091	85303	89422			

EAST MANUFACTURING CORP.

O.E.M #	Gabriel	Upgrade	O.E.M #	Gabriel	Upgrade	O.E.M #	Gabriel	Upgrade	O.E.M #	Gabriel	Upgrade
517-05001-18	87015		517-05010-07	83214		517-05805-20	85000	89436	517-05916-14	83124	89407
517-05001-23	85005	89430	517-05022-07	83217		517-05806-20	85029		A-20002	85000	89436
517-05006-20	85030	89440	517-05110-20	85000	89436	517-05808-20	85738		A-20126	85323	89436
517-05009-14	83125		517-05511-14	83128		517-05809-20		89437			

ELDORADO NATIONAL

O.E.M #	Gabriel	Upgrade	O.E.M #	Gabriel	Upgrade	O.E.M #	Gabriel	Upgrade	O.E.M #	Gabriel	Upgrade
13208701	85746		13208801	85745							

EUCLID

Euclid	Gabriel	Upgrade	Euclid	Gabriel	Upgrade	Euclid	Gabriel	Upgrade	Euclid	Gabriel	Upgrade
E14009	85933	89454	E83200	83200		E83209	83209	89414	E83221	83221	
E14021	85955		E83201	83201		E83213	83213		E83223	83223	
E14022	85955		E83202	83202		E83214	83214		E83225	83225	
E14037	85967		E83203	83203	89436	E83215	83215		E83242	83242	
E14042	85965		E83204	83204		E83216	83216				
E14043	85966		E83205	83209	89414	E83217	83217				
E14045	83143		E83206	83206		E83218	83122	89406			
E14046	83142		E83207	83207	89407	E83219	83219				

Important Note: Competitive Interchanges are to be used for stocking purposes only. Where multiple crosses are identified, please reference the applications section of this catalog. / **Remarque importante:** Les interchanges concurrentiels ne s'utilisent qu'aux fins de stocks. Dans le cas de références multiples, consulter la section des applications du catalogue. / **Nota importante:** Dans le cas de références multiples, consulter la section des applications du catalogue. / **Nota importante:** Se pueden usar intercambios competitivos para propósitos de almacenamiento solamente. Cuando se identifican intercambios múltiples, consulte la sección de aplicaciones de este catálogo.

COMPETITIVE & O.E.M. INTERCHANGE LIST
Lista de Intercambios contra Competidores y Equipo Original.
Liste d'interchange de produits compétitifs & d'équipement original (OEM)

EUCLID... cont'd

Euclid	Gabriel	Upgrade	Euclid	Gabriel	Upgrade	Euclid	Gabriel	Upgrade	Euclid	Gabriel	Upgrade
E83300	83300		E85001	85001	89410	E85302	85302	89420	E85705	85705	
E83301	83301		E85003	85003	89411	E85303	85303	89422	E85706	85706	
E83302	83302		E85005	85005	89430	E85304	85304		E85709	85709	
E83303	83303		E85006	85006		E85305	85305		E85711	85711	
E83304	83304		E85007	85007	89412	E85307	85307		E85712	85712	
E83308	83308	89435	E85008	85008		E85308	85308	89422	E85713	85713	
E83309	83309	89446	E85010	85010		E85310	85310	89423	E87000	85711	
E83310	83221		E85011	85011		E85311	85311	89424	E87001	85734	
E83311	83311		E85012	85012	89413	E85312	85312		E87003	85700	
E83312	83312	89409	E85013	85013	89414	E85313	85313		E87004	85735	
E83314	83314		E85014	85014		E85314	85314	89425	E87006	85736	
E83318	83318		E85024	85024	89416	E85318	85318		E87011	85707	
E83353	83353		E85026	85026	89417	E85700	85700		E87012	85705	
E83400	83400		E85029	85029		E85702	85702		E87013	85706	
E83401	83401		E85030	85030	89440	E85703	85703				
E85000	85000	89436	E85300	85300	89419	E85704	85704				

FLEETRITE

Fleetrite	Gabriel	Upgrade	Fleetrite	Gabriel	Upgrade	Fleetrite	Gabriel	Upgrade	Fleetrite	Gabriel	Upgrade
AMS600101	85003	89411	AMS600150	85009		AMS650120	85010		AMS650431	85909	
AMS600102	85005	89430	AMS600151	85024	89416	AMS650121	89432		AMS650432	85910	
AMS600103	85014		AMS600152	83242		AMS650122	85063		AMS650433	85910	
AMS600104	85000	89436	AMS600153	85003	89411	AMS650123	85054	89438	AMS650434	85012	89413
AMS600105	83304		AMS600154	83104		AMS650124	85053	89442	AMS650435	85901	
AMS600106	83312	89409	AMS600155	83103		AMS650128	85031		AMS650436	85900	
AMS600107	83309	89446	AMS600156	83103		AMS650129	85701		AMS650439	85718	
AMS600108	83209	89414	AMS600157	83221		AMS650130	85061	89450	AMS650440	85711	
AMS600109	83217		AMS600162	83103		AMS650139	85918	89449	AMS650441	85704	
AMS600110	83303		AMS600163	83101		AMS650400	85033	89427	AMS650442	85700	
AMS600111	83301		AMS600164	83613		AMS650401	85013	89414	AMS650443	85706	
AMS600112	83456	89447	AMS600165	83636		AMS650402	85311	89424	AMS650444	85311	89424
AMS600113	83215		AMS600166	85052		AMS650404	85310	89423	AMS650445	85731	
AMS600114	83125		AMS600167	83128		AMS650405	85023	89415	AMS650446	85730	
AMS600116	83216		AMS600168	83635		AMS650406	85024	89416	AMS650447	85703	
AMS600117	83308	89435	AMS600169	85051		AMS650407	85736		AMS650448	85700	
AMS600118	83219		AMS600172	85005	89430	AMS650408	85319	89428	AMS650449	85702	
AMS600119	83314		AMS600173	85043		AMS650409	85003	89411	AMS650451	85029	
AMS600120	G63605		AMS600174	83125		AMS650410	85300	89419	AMS650452	85733	
AMS600123	G63183		AMS600175	83120		AMS650411	85036	89405	AMS650453	85904	
AMS600125	83123	89405	AMS600202	83009		AMS650412	83122	89406	AMS650454	85713	
AMS600126	83400		AMS650101	85062	89408	AMS650413	65413		AMS650455	85716	
AMS600127	83161		AMS650102	85001	89410	AMS650414	65414		AMS650456	85376	
AMS600128	83401		AMS650103	85320	89429	AMS650415	85046	89434	AMS650458	85908	
AMS600129	83317		AMS650104	65104		AMS650416	85323	89436	AMS650459	85043	
AMS600130	83204		AMS650105	85026	89417	AMS650417	85322		AMS650462	85913	
AMS600131	83318		AMS650106	65106		AMS650418	85906	89407	AMS650463	85040	
AMS600132	83215		AMS650107	85316	89426	AMS650419	85000	89436	AMS650464	85716	
AMS600133	83362		AMS650108	85030	89432	AMS650420	85013	89414	AMS650465	85914	
AMS600134	83221		AMS650109	85058	89431	AMS650421	85916		AMS650466	85047	89435
AMS600136	83353		AMS650110	85005	89430	AMS650422	85912		AMS650468	85069	89455
AMS600138	83100		AMS650111	85006		AMS650423	85907		AMS650471	85302	89420
AMS600139	83353		AMS650112	89402		AMS650424	85905		AMS650472	85330	
AMS600142	83209	89414	AMS650113	85012	89413	AMS650425	89441		AMS650473	85329	
AMS600145	85040		AMS650114	85006		AMS650426	85054	89438	AMS650474	85712	
AMS600146	83105		AMS650115	85027	89418	AMS650427	85903				
AMS600147	83216		AMS650116	85303	89422	AMS650428	85321				
AMS600148	85026	89417	AMS650118	83215		AMS650429	85030	89440			
AMS600149	83217		AMS650119	85029		AMS650430	85712				

Important Note: Competitive Interchanges are to be used for stocking purposes only. Where multiple crosses are identified, please reference the applications section of this catalog. / **Remarque importante:** Les interchanges concurrentiels ne s'utilisent qu'aux fins de stocks. Dans le cas de références multiples, consulter la section des applications du catalogue. / **Nota importante:** Dans le cas de références multiples, consulter la section des applications du catalogue. / **Nota importante:** Se pueden usar intercambios competitivos para propósitos de almacenamiento solamente. Cuando se identifican intercambios múltiples, consulte la sección de aplicaciones de este catálogo.

COMPETITIVE & O.E.M. INTERCHANGE LIST
Lista de Intercambios contra Competidores y Equipo Original.
Liste d'interchange de produits compétitifs & d'équipement original (OEM)

FLEETRITE... cont'd

Fleetrite	Gabriel	Upgrade	Fleetrite	Gabriel	Upgrade	Fleetrite	Gabriel	Upgrade	Fleetrite	Gabriel	Upgrade
AMS650475	85065		AMS660142	83209	89414	AMS660201	83308	89435	AMS700116	83136	
AMS650478	85030	89440	AMS660145	85040		AMS660202	83009		AMS700117	85324	
AMS650479	83122	89406	AMS660146	83105		AMS660203	83112		AMS700119	85336	
AMS650480	83109		AMS660147	83216		AMS660204	83010		AMS700120	85332	
AMS650480	83111		AMS660148	85026	89417	AMS660205	83003		AMS700121	83136	
AMS650481	83123	89405	AMS660149	85042		AMS660208	G63616		AMS700401	85700	
AMS650482	85006		AMS660150	G63616		AMS660209	83014		AMS700402	85310	89423
AMS650486	85066	89448	AMS660153	85003	89411	AMS660211	83110		AMS700403	85702	
AMS65107	85316	89426	AMS660154	83104		AMS660212	83015		AMS700404	85311	89424
AMS65109	85058	89431	AMS660155	83103		AMS660213	85009		AMS700405	85300	89419
AMS65144	85957		AMS660157	85030	89440	AMS660214	83002		AMS700406	85711	
AMS65146	85925		AMS660160	83114		AMS660215	85059		AMS700407	85712	
AMS65158	85954		AMS660161	G63610		AMS660216	83123	89405	AMS700408	85704	
AMS660102	85005	89430	AMS660162	83103		AMS660218	83137		AMS700409	85701	
AMS660103	85014		AMS660164	83613		AMS660219	83215		AMS700410	85314	89425
AMS660104	85000	89436	AMS660165	83636		AMS660220	83109		AMS700411	85703	
AMS660105	83304		AMS660166	85052		AMS660223	85055	89439	AMS700413	85705	89447
AMS660106	83312	89409	AMS660167	83128		AMS660224	83111		AMS700414	85723	
AMS660107	83309	89446	AMS660168	83635		AMS660225	83200		AMS700415	85318	
AMS660108	83209	89414	AMS660169	85051		AMS660232	83114		AMS700416	85709	
AMS660109	83217		AMS660170	83016		AMS660233	83023		AMS700418	85003	89411
AMS660110	83303		AMS660171	83017		AMS660234	83013		AMS700419	85708	
AMS660111	83301		AMS660172	83126	89430	AMS660236	83025		AMS700420	85733	
AMS660112	83456	89447	AMS660173	85043		AMS660237	83005		AMS700421	85712	
AMS660113	83215		AMS660174	83125		AMS660238	83101		AMS700422	85308	89422
AMS660114	85006		AMS660175	83120		AMS660244	83125		AMS700423	85724	89443
AMS660116	83216		AMS660176	83018		AMS660247	83116		AMS700424	85333	
AMS660117	83308	89435	AMS660177	83019		AMS660247	83118		AMS74421	85708	
AMS660118	85012	89413	AMS660179	83162		AMS660248	83117		AMS85722	83400	
AMS660119	83314		AMS660182	83004		AMS660502	646155		AMS85736	G63394	
AMS660120	G63605		AMS660183	85012	89413	AMS660504	632147		AMS85768	83209	89414
AMS660123	G63183		AMS660187	85071		AMS700101	85308	89422	AMS85802	83216	
AMS660125	83123	89405	AMS660188	85045		AMS700102	85303	89422	AMS85803	G63306	
AMS660126	83400		AMS660189	83136		AMS700103	85302	89420	AMS85821	G63406	
AMS660127	83161		AMS660190	83107		AMS700104	85304		AMS85853	G63183	
AMS660128	83401		AMS660191	83216		AMS700105	85314	89425	AMS85895	83207	89407
AMS660129	83317		AMS660192	85001	89410	AMS700106	85301		AMS85900	G63386	
AMS660130	83204		AMS660193	83001		AMS700107	85307		AMS85901	G63387	
AMS660131	83318		AMS660194	83207	89407	AMS700108	85315		AMS85904	G63299	
AMS660132	83215		AMS660195	83130		AMS700111	85320	89429	AMS85905	G63405	
AMS660133	83362		AMS660196	G63610		AMS700112	85722		AMS85909	G63398	
AMS660134	83221		AMS660197	G63866		AMS700113	85736		AMS85932	G63398	
AMS660136	83353		AMS660198	83007		AMS700114	85701		AMS85960	G63366	
AMS660138	83100		AMS660200	83008		AMS700115	85712				

FLEETWOOD RV

O.E.M #	Gabriel	Upgrade	O.E.M #	Gabriel	Upgrade	O.E.M #	Gabriel	Upgrade	O.E.M #	Gabriel	Upgrade
141700131809	85029		16-16736-000	85029		16-16873-000	85029		16-18103-000	85900	
141700131810	83160		16-16737-000	83160		16-16874-000	83160		481700000493	85900	

FLUIDRIVE

O.E.M #	Gabriel	Upgrade	O.E.M #	Gabriel	Upgrade	O.E.M #	Gabriel	Upgrade	O.E.M #	Gabriel	Upgrade
2697	85712										

FLXIBLE BUS

O.E.M #	Gabriel	Upgrade	O.E.M #	Gabriel	Upgrade	O.E.M #	Gabriel	Upgrade	O.E.M #	Gabriel	Upgrade
015813	85708		06-0367-00157	85701		22024061	85704		22025066	85703	
06-0367-00151	85700		22012067	85700		22024062	85701		22025067	85704	
06-0367-00156	85702		22012114	85700		22024506	85703		22025305	85704	

Important Note: Competitive Interchanges are to be used for stocking purposes only. Where multiple crosses are identified, please reference the applications section of this catalog. / **Remarque importante:** Les interchanges concurrentiels ne s'utilisent qu'aux fins de stocks. Dans le cas de références multiples, consulter la section des applications du catalogue. / **Nota importante:** Dans le cas de références multiples, consulter la section des applications du catalogue. / **Nota importante:** Se pueden usar intercambios competitivos para propósitos de almacenamiento solamente. Cuando se identifican intercambios múltiples, consulte la sección de aplicaciones de este catálogo.

COMPETITIVE & O.E.M. INTERCHANGE LIST

Lista de Intercambios contra Competidores y Equipo Original.

Liste d'interchange de produits compétitifs & d'équipement original (OEM)

FLXIBLE BUS... cont'd

O.E.M #	Gabriel	Upgrade	O.E.M #	Gabriel	Upgrade	O.E.M #	Gabriel	Upgrade	O.E.M #	Gabriel	Upgrade
3166657	85700		6-367-17	85700		97-2201-00001	85703		97-2210-00157	85708	
3192333	85700		6-367-2	85736		97-2201-00002	85703		97-2210-00160	85705	89447
48-1-239	85736		6-367-3	85304		97-2201-00003	85703		97-2210-00162	85701	
48-1-241	85712		6-367-4	83217		97-2201-00004	85703		97-2210-00164	85708	
4975518	85704		6-367-6	85711		97-2201-00005	85703		97-2210-00170	85733	
6-05-1	85736		6-367-7	85305		97-2201-00006	85703		97-9999-00732	85707	
6-05-10	85734		6-367-8	85700		97-2201-00007	85703		97-9999-00807	85307	
6-05-13	85304		6-367-9	85711		97-2201-00008	85731		97-9999-02514	85700	
6-05-2	85736		680029	85301		97-2201-00009	85703		97-9999-02515	85702	
6-05-3	85736		680155	85712		97-2201-00151	85700		97-9999-02516	85701	
6-05-4	85736		680320	85703		97-2210-00001	85704		97-9999-02519	85707	
6-05-5	85307		695125	85704		97-2210-00002	85704		97-9999-02592	85710	
6-05-6	85736		74412	85704		97-2210-00003	85704		97-9999-02595	85313	
6-05-7	85736		87-2519-00001	85703		97-2210-00004	85704		97-9999-02632	85711	
6-05-8	85736		87-2519-00002	85731		97-2210-00005	85704		97-9999-02633	85311	89424
6-05-9	85304		87-2519-00003	85703		97-2210-00006	85704		97-9999-02634	85733	
6-367-1	85711		87-2519-00004	85731		97-2210-00009	85704		97-9999-02635	85718	
6-367-11	85711		87-2520-00001	85704		97-2210-00010	85730		97-9999-02636	85716	
6-367-12	85700		87-2520-00002	85730		97-2210-00011	85704				
6-367-14	85700		87-2520-00003	85704		97-2210-00153	85701				
6-367-16	85700		87-2520-00004	85730		97-2210-00156	85702				

FLYER INDUSTRIES

O.E.M #	Gabriel	Upgrade	O.E.M #	Gabriel	Upgrade	O.E.M #	Gabriel	Upgrade	O.E.M #	Gabriel	Upgrade
009863	85722		22012067	85700		3192333	85700		592-6568	85700	
015915	85711		22012114	85700		4975501	85700		5979574	85700	
15813	85708		3166657	85700		4975552	85711				

FORD

O.E.M #	Gabriel	Upgrade	O.E.M #	Gabriel	Upgrade	O.E.M #	Gabriel	Upgrade	O.E.M #	Gabriel	Upgrade
0017LA-18080-G	83161		471700011530	85181		5U2Z-18V125-BDA	G63623		9U9Z-18124-A	83209	
1C34-18045-AA	83209		471700011531	85180		5U2Z-18V125-BGA	G63778		9U9Z-18125-A	83122	
1C34-18045-JA	83209		47902-13	83122	89406	5U2Z-18V125-BS	G63607		AA-494	83131	
1C44-18080-AA	83123	89405	47902-28	85013	89414	5U2Z-18V125-BT	G63525		AA-615	83135	
2C4Z-18124-BA	83175		47902-8	83122	89406	5U2Z-18V125-BU	G63524		AA-616	83175	
2C7Z-18125-AA	G63837		4C4Z-18124-HB	83135		5U2Z-18V125-F	G63676		AA-617	85928	
2C7Z-18125-CA	G63607		4C4Z-18124-P	83135		5U2Z-18V125-G	G63837		ASH-1022	83209	
3553628C1	85927		4C4Z-18124-QA	83175		5U2Z-18V125-H	G63406		ASH-1023	83122	
3553628C2	85927		4C4Z-18124-RA	85928		60670-008	83123	89405	ASH-1205	83209	
3578858C1	85926		4C4Z-18125-B	83317		680029	85301		ASH-1206	83122	
3578858C2	85926		4C4Z-18125-DA	85926		6C2Z-18124-B	G63929		ASH-1228	83209	
3584116C1	83175		4U2Z-18V124-AA	G63678		6ETZ-18124-AA	83145		ASH-1230	83122	
3584116C2	83175		501906C92	83317		6ETZ-18125-A	83146		ASH-137	83122	
3584117C2	83135		57241-2	83109		6U2Z-18V125-B	G63607		ASH-23486	G63461	
3584118C2	85928		57365-111	85006	89401	6U2Z18V125A	G63837		ASH-24446	83215	
3U2Z-18124-BAA	G63809		5C3Z-18124-JA	G63969		70127	85006	89401	ASH-24659	85181	
3U2Z-18124-BV	G63614		5C3Z-18125-CF	77969		70128	85006	89401	ASH-24660	85180	
3U2Z-18124-BW	G63614		5C3Z-18125-DA	77968		7C34-18045-HB	G63969		ASH-247	G63461	
3U2Z-18124-EA	G63772		5U2Z-18V124-AA	G63714		7C34-18080-DCB	77968		ASH-294	83209	
3U2Z-18124-FA	G63608		5U2Z-18V124-AHA	G63622		7W7Z-18125-B	69574		ASH-397	83131	
3U2Z-18124-FAA	G63809		5U2Z-18V124-AU	G63772		87HU-18045-AA	85301		AT-610	G63461	
3U2Z-18124-JAA	G63614		5U2Z-18V124-BA	G63716		90044769	83207	89407	AT-611	G63461	
3U2Z-18124-YAA	G63809		5U2Z-18V124-CAA	G63809		90044770	83207	89407	AT-620	83209	
3U2Z-18125-AD	69575		5U2Z-18V124-DB	G63455		90045068		89441	AT-621	83122	
3U2Z-18125-CA	G63607		5U2Z-18V124-GA	G63809		90045099	85906	89407	AT-696	83140	
3U2Z-18125-DA	G63525		5U2Z-18V124-LA	G63929		90045132	85909		AT-766	83209	
3U2Z-18125-EA	G63524		5U2Z-18V125-AE	G63808		9U94-18045-AA	83209		AT-811	83135	
3U2Z-18125-RA	G63623		5U2Z-18V125-AF	G63810		9U94-18080-AA	83122		AX-267A	83309	89446

Important Note: Competitive Interchanges are to be used for stocking purposes only. Where multiple crosses are identified, please reference the applications section of this catalog. / **Remarque importante:** Les interchanges concurrentiels ne s'utilisent qu'aux fins de stocks. Dans le cas de références multiples, consulter la section des applications du catalogue. / **Nota importante:** Dans le cas de références multiples, consulter la section des applications du catalogue. / **Nota importante:** Se pueden usar intercambios competitivos para propósitos de almacenamiento solamente. Cuando se identifican intercambios múltiples, consulte la sección de aplicaciones de este catálogo.

COMPETITIVE & O.E.M. INTERCHANGE LIST
Lista de Intercambios contra Competidores y Equipo Original.
Liste d'interchange de produits compétitifs & d'équipement original (OEM)

FORD... cont'd

O.E.M #	Gabriel	Upgrade	O.E.M #	Gabriel	Upgrade	O.E.M #	Gabriel	Upgrade	O.E.M #	Gabriel	Upgrade
AX-310	83215		C5TZ-18124-A	83308		D2HF-18124-AA	83314		D7HT-18124-HA	83219	
B3Q-18124-A	83219		C6PF-18077-A	G63306		D2HT-18045-CA	83314		D7HT-18124-JA	83308	
B3Q-18125-A	83217		C6PF-18077-AC	83161		D2HT-18045-EA	83312	89409	D7HT-18124-KA	85301	
B3TZ-18125-A	83217		C6PF-18077-DD	83216		D2HT-18045-GA	83308		D7HT-18125-BA	83217	
B6TZ-18124-A	83219		C6PF-18077-DE	83219		D2HT-18080-HA	83225		D7HT-18125-CA	83217	
B6TZ-18125-B	83161		C6PF-18077-DL	83312	89409	D2HZ-18080-A	83209	89414	D7HT-18125-DA	83215	
B6TZ-18125-C	83161		C6PF-18077-DN	83314		D2HZ-18125-A	83209	89414	D7HT-18125-FA	83123	89405
B6TZ-18125-E	83161		C6PF-18077-F	83225		D2HZ-18125-B	83209	89414	D7HZ-18125-A	83215	
B7C-18125-A	83217		C6TA-18045-U	85301		D2KF-18045-AA	83312	89409	D7KF-18045-EA	83312	89409
B7T-18124-C	83225		C6TA-18045-V	85301		D2KF-18124-AA	83312	89409	D7TA-18124-GA	83314	
B7TZ-18124-B	83216		C6TA-18045-Y	85301		D2TA-18045-AAA	83219		D7TZ-18125-C	83217	
B7TZ-18124-C	83216		C6TA-18045-Z	85301		D2TA-18045-ZA	83219		D8HZ-18124-A	85301	
B7TZ-18124-D	83219		C6TS-18080-A	83217		D2TF-18045-AA	83312	89409	D8HZ-18125-A	83209	89414
B7TZ-18124-E	83217		C6TZ-18124-D	85301		D2TF-18045-FA	83312	89409	D8HZ-18125-B	83123	89405
B7TZ-18125-C	83217		C6TZ-18124-E	85301		D2TF-18045-GA	83308		EOHT-18045-AA	83309	89446
B8Q-18125-A	85307		C6TZ-18124-H	85301		D2TF-18080-HA	83225		EOHT-18045-AB	83309	89446
B8QZ-18124-A	83312	89409	C6TZ-18124-J	85301		D2TF-18080-NA	83217		EOHT-18080-AA	83215	
B8TZ-18124-A	83219		C7HZ-18124-A	83312	89409	D2TF-18124-F	83309	89446	EOHZ-18124-A	83309	89446
B9TT-18045-C	83219		C7PF-18077-A	83225		D2TZ-18124-A	83308		E1TA-18045-AA	83309	89446
B9TT-18045-D	83219		C7PF-18077-Z	83217		D2TZ-18124-E	83312	89409	E1TD-18045-AA	83309	89446
B9TT-18080-B	83161		C7TA-18045-R	83216		D2TZ-18124-F	83309	89446	E5HT-18045-AA	85301	
B9TZ-18125-B	83161		C7TA-18045-Z	85301		D2TZ-18124-G	83314		E5HT-18045-DA	85301	
C0TT-18045-A	83219		C8HA-18045-A	83312	89409	D2TZ-18124-H	83308		E5HT-18045-EA	85301	
C0TT-18045-D	83216		C8PF-18045-CM	83216		D2TZ-18124-J	83312	89409	E5HT-18080-DA	85315	
C0TZ-18124-A	83216		C8PF-18045-S	83161		D3TA-18045-BA	83219		E5HT-18080-EA	85315	
C1TT-18045-C	83312	89409	C8PF-18045-T	83161		D3TZ-18124-B	83219		E6HT-18080-AA	83215	
C1TT-18045-D	G63406		C8TA-18045-AA	G63386		D3TZ-18125-C	83217		E6HZ-18124-A	85301	
C1TT-18045-E	83314		C8TA-18080-Y	83161		D3TZ-18125-D	83217		E6HZ-18124-D	85301	
C1TT-18045-G	83216		C8TA-18080-Z	83161		D4HA-18080-A	83209	89414	E6HZ-18125-D	83215	
C1TT-18080-B	83217		C8TZ-18125-D	83161		D4HA-18080-AA	83209	89414	E6HZ-18125-E	85315	
C1TZ-18045-C	83312	89409	D0HA-18045-D	83309	89446	D4TF-18045-AA	83312	89409	E6HZ-18125-F	85315	
C1TZ-18124-A	83217		D0HA-18045-E	83312	89409	D4TZ-18124-J	83308		E7HZ-18124-A	85301	
C1TZ-18124-B	83216		D0HZ-18124-A	83309	89446	D5TZ-18124-B	83308		E7XZ-18124-A	G63386	
C1TZ-18124-C	83312	89409	D0HZ-18124-B	83312	89409	D5TZ-18124-C	83312	89409	E7XZ-18124-B	G63500	
C1TZ-18124-D	83309	89446	D0HZ-18124-C	83314		D7HA-18080-AA	83123	89405	E7XZ-18124-C	G63511	
C1TZ-18124-E	83312	89409	D1TF-18045-LA	83312	89409	D7HF-18045-FA	83312	89409	E7XZ-18124-D	G63396	
C1TZ-18124-F	83312	89409	D1TZ-18124-D	83308		D7HF-18080-AA	83215		E7XZ-18124-F	G63398	
C1TZ-18124-N	83314		D1TZ-18124-E	83216		D7HF-18125-AA	83215		E7XZ-18124-G	G63398	
C1TZ-18124-P	83312	89409	D1TZ-18124-F	83312	89409	D7HT-18045-BA	83312	89409	E7XZ-18125-A	G63350	
C1TZ-18125-B	83217		D1TZ-18125-E	83217		D7HT-18045-CA	83314		E7XZ-18125-B	G63387	
C1VT-18080-B	83217		D2EF-18045-AA	83312	89409	D7HT-18045-DA	83309	89446	E7XZ-18125-C	G63409	
C2TA-18045-A	83216		D2EF-18124-AA	83312	89409	D7HT-18045-EA	83312	89409	E7XZ-18125-D	G63406	
C2TA-18045-B	83308		D2HA-18045-E1A	85304		D7HT-18045-GA	83308		E7XZ-18125-E	G63406	
C2TZ-18124-A	83308		D2HA-18045-E1B	85304		D7HT-18045-HA	85012	89413	E7XZ-18125-G	G63811	
C3TA-18045-A	83216		D2HA-18045-E2A	85304		D7HT-18045-JA	83308		E7XZ-18125-J	G63299	
C3TZ-18124-A	83308		D2HA-18045-E2B	85304		D7HT-18045-NA	85301		E9HS-18045-AA	83309	89446
C4HZ-18124-A	83312	89409	D2HA-18045-EB	85301		D7HT-18080-AA	83215		E9HS-18080-AA	85716	
C4HZ-18124-B	83309	89446	D2HA-18045-F1A	85301		D7HT-18080-BA	83225		E9HZ-18124-A	83309	89446
C4HZ-18124-C	83314		D2HA-18045-F1B	85301		D7HT-18080-CA	83225		E9HZ-18125-A	85716	
C4HZ-18124-D	83312	89409	D2HA-18045-F2A	85301		D7HT-18080-DA	83215		E9HZ-18125-AA	85716	
C4HZ-18124-E	83309	89446	D2HA-18045-F2B	85301		D7HT-18124-BA	83312	89409	FOHS-18045-AA	85006	89401
C4HZ-18124-F	83308		D2HF-18045-A	83314		D7HT-18124-CA	83314		FOHT-18045-AA	85006	89401
C4PF-18045-H	83216		D2HF-18045-AA	83314		D7HT-18124-DA	83309	89446	FOHT-18045-CA	85006	89401
C4TZ-18124-AA	83308		D2HF-18045-BA	83309	89446	D7HT-18124-EA	83312	89409	FOHT-18080-AA	83122	89406
C4TZ-18124-AB	83308		D2HF-18045-CA	83308		D7HT-18124-FA	83312	89409	F0HZ-18124-A	85006	89401
C4TZ-18124-B	83308		D2HF-18045-DA	83312	89409	D7HT-18124-GA	83308		F0HZ-18124-B	85006	

Important Note: Competitive Interchanges are to be used for stocking purposes only. Where multiple crosses are identified, please reference the applications section of this catalog. / **Remarque importante:** Les interchanges concurrentiels ne s'utilisent qu'aux fins de stocks. Dans le cas de références multiples, consulter la section des applications du catalogue. / **Nota importante:** Dans le cas de références multiples, consulter la section des applications du catalogue. / **Nota importante:** Se pueden usar intercambios competitivos para propósitos de almacenamiento solamente. Cuando se identifican intercambios múltiples, consulte la sección de aplicaciones de este catálogo.

COMPETITIVE & O.E.M. INTERCHANGE LIST

Lista de Intercambios contra Competidores y Equipo Original.

Liste d'interchange de produits compétitifs & d'équipement original (OEM)

FORD... cont'd

O.E.M #	Gabriel	Upgrade	O.E.M #	Gabriel	Upgrade	O.E.M #	Gabriel	Upgrade	O.E.M #	Gabriel	Upgrade
F0HZ-18125-A	83122	89406	F4HT-18080-AA	85314	89425	F6HT-18045-MA	85006	89401	LA-18080	83161	
F1HT-18045-AA	83309	89446	F4HT-18080-AB	85314	89425	F6HT-18080-B	83109		LA-18080-A	83161	
F1HT-18045-CA	83308		F4HT-18080-BA	85001	89410	F6HT-18080-CA	85314	89425	LA-18080-B	83161	
F1HT-18045-CB	83216		F4TA-18045-TA	G63455		F6HT-18080-DA	83109		LA-18080-C	83161	
F1HT-18045-DA	83312	89409	F4TA-18080-PA	G63461		F6HT-18080-EA	85906	89407	LA-18080-F	83161	
F1HT-18045-DB	83308		F4TZ-18124-D	G63414		F6HT-18080-FC	85013	89414	LA-18080-J	83161	
F1HT-18045-EA		89402	F4TZ-18124-K	G63455		F6HT-18080-JA	85305		TAAH-18080-A	83161	
F1HT-18045-EB		89402	F4TZ-18125-E	G63461		F6HZ-18080-FC	85013	89414	TAAH-18080-A2	83161	
F1HT-18045-GA	85006	89401	F4TZ-18125-L	G63406		F6HZ-18124-A	85054	89438	TAAH-18080-A3	83161	
F1HT-18045-GB		89403	F57Z-18125-BB	G63679		F6HZ-18124-B	83308		TAAK-18080-A	83161	
F1HT-18045-HB	85006	89401	F5HZ-18124-A	83314		F6HZ-18124-C	85055	89439	TAAK-18080-A1	83161	
F1HT-18045-KB	85006	89401	F5HZ-18124-AA	83314		F6HZ-18124-D	85055	89439	TAAK-18080-A2	83161	
F1HT-18045-LB	85006	89401	F5HZ-18124-B	83107		F6HZ-18124-E	85055	89439	TACAA-18045-A	83216	
F1HT-18045-NA	85040		F5HZ-18124-C	85063		F6HZ-18124-F	85055	89439	TANNA-18045-A	83312	89409
F1HT-18045-RA		89402	F5HZ-18124-D	83125		F6HZ-18124-G	85054	89438	TBAK-18080-A	83161	
F1HT-18045-RA	89441		F5HZ-18124-DA	83125		F6HZ-18124-H	85054	89438	TBDA-18080-A	83217	
F1HT-18045-RB		89402	F5HZ-18125-A	85314	89425	F6HZ-18124-J	83200	89402	TBDA-18080-B	83217	
F1HZ-18124-A	83309	89446	F5HZ-18125-AA	85314	89425	F6HZ-18124-KA	83200	89402	TDAA-18080-A	83161	
F1HZ-18124-AA	83309	89446	F5HZ-18125-B	85001	89410	F6HZ-18124-MA	85006	89401	TDAA-18080-B	83217	
F1HZ-18124-B	83308		F5HZ-18125-BA	85001	89410	F6HZ-18125-A	85314	89425	TDBA-18045-A	83219	
F1HZ-18124-C		89402	F5HZ-18125-DA	85314	89425	F6HZ-18125-B	83109		TDBA-18045-B	83219	
F1HZ-18124-D	85006	89401	F5TZ-18124-B	G63608		F6HZ-18125-C		89441	TDBA-18080-A	83217	
F1HZ-18124-E	85006	89401	F5TZ-18125-BC	G63607		F6HZ-18125-D	85013	89414	TDBA-18080-B	83217	
F1HZ-18124-F	85006	89401	F5UZ-18124-A	G63622		F6HZ-18125-JA	85305		TDBA-18080-C	83217	
F1HZ-18124-G	85006	89401	F5UZ-18124-B	G63622		F7C2Z-18124-BR	G63929		TDBE-18045-A	83219	
F1HZ-18124-H	85040		F5UZ-18125-A	G63623		F7TA-18045-AA	G63608		TFAA-18045-B	83219	
F1HZ-18124-J	83308		F5UZ-18125-C	G63624		F7TA-18080-BA	G63607		TFAA-18045-C	83219	
F1HZ-18124-K		89402	F6HT-18045-AA	85054	89438	F81A-18080-DCA	G63461		TFAA-18080-A	85307	
F2HT-18045-BA	85376		F6HT-18045-AC	85054	89438	F81A-18080-ZC	83140		THAB-18045-A	83219	
F2HT-18045-CA	85376		F6HT-18045-BC	85047	89435	F81Z-18124-AL	G63622		THAB-18045-B	83219	
F2HT-18045-DA	85006	89401	F6HT-18045-CC	85055	89439	F81Z-18124-BK	G63809		TQSH-18045-A	83309	89446
F2HT-18080-DA	85712		F6HT-18045-EB	85055	89439	F81Z-18124-PA	85928		XC35-18045-AB	83131	
F2HZ-18124-A	85376		F6HT-18045-EC	85055	89439	F81Z-18125-DC	G63461		XC35-18045-AD	83131	
F2HZ-18124-B	85301		F6HT-18045-GB	85030	89440	F81Z-18125-ZA	83140		XC35-18045-JA	83131	
F2HZ-18124-C	85006	89401	F6HT-18045-GC	85030	89440	F87Z-18125-CA	G63773		XC3Z-18124-JA	83131	
F2HZ-18125-A	85712		F6HT-18045-HB	85054	89438	F87Z-18125-RA	G63775		XC45-18045-AA	83216	
F4HT-18045-AB	83314		F6HT-18045-HC	85054	89438	FC44-18045-BB	85181		XL2Z-18124-EA	G63678	
F4HT-18045-AC	83314		F6HT-18045-JB	83200	89402	FC44-18080-AB	85180		XL2Z-18125-BA	G63679	
F4HT-18045-CB	83107		F6HT-18045-JC	83200	89402	FC4Z-18124-B	85181		XL2Z-18125-CA	G63679	
F4HT-18045-DA	85063		F6HT-18045-KA	83200	89402	FC4Z-18124-HB	83135		XL2Z-18125-EA	G63679	
F4HT-18045-EA	83125		F6HT-18045-LA	85376		FC4Z-18125-A	85180		YL5Z-18124-AA	G63772	

FORD CAB SHOCKS

O.E.M #	Gabriel	Upgrade	O.E.M #	Gabriel	Upgrade	O.E.M #	Gabriel	Upgrade	O.E.M #	Gabriel	Upgrade
1201-0012	83023		1202-0012	83023		1202-0042	83025		F6HZ-5K407-AB	83034	
1201-1043	83025		1202-0022	83046		1202-1043	83025		F6HZ-5K407-BA	83033	
1201-1044	83025		1202-0032	83016		1202-1044	83025		F8HT-5K407-AA	83033	

FOREST RIVER INC

O.E.M #	Gabriel	Upgrade	O.E.M #	Gabriel	Upgrade	O.E.M #	Gabriel	Upgrade	O.E.M #	Gabriel	Upgrade
141700131809	85029		16-16736-000	85029		16-16873-000	85029		16-18103-000	85900	
141700131810	83160		16-16737-000	83160		16-16874-000	83160		481700000493	85900	

FREIGHTLINER

O.E.M #	Gabriel	Upgrade	O.E.M #	Gabriel	Upgrade	O.E.M #	Gabriel	Upgrade	O.E.M #	Gabriel	Upgrade
10-12030-002	85320	89429	10-12032-003	85320	89429	10-12390-000	85920		10-13021-000	85918	89449
10-12032-000	85320	89429	10-12032-004	85320	89429	10-12542-000	85901		10-13051-001	85005	89430
10-12032-001	85320	89429	10-12046-000	85320	89429	10-12594-000	85984		10-13063-000	85918	89449
10-12032-002	85320	89429	10-12388-000	85920		10-12703-000	85918	89449	10-13205-000	85918	89449

Important Note: Competitive Interchanges are to be used for stocking purposes only. Where multiple crosses are identified, please reference the applications section of this catalog. / **Remarque importante:** Les interchanges concurrentiels ne s'utilisent qu'aux fins de stocks. Dans le cas de références multiples, consulter la section des applications du catalogue. / **Nota importante:** Dans le cas de referencias multiples, consultar la seccion de aplicaciones del catalogo. / **Nota importante:** Se pueden usar intercambios competitivos para propósitos de almacenamiento solamente. Cuando se identifican intercambios múltiples, consulte la sección de aplicaciones de este catálogo.

COMPETITIVE & O.E.M. INTERCHANGE LIST
Lista de Intercambios contra Competidores y Equipo Original.
Liste d'interchange de produits compétitifs & d'équipement original (OEM)

FREIGHTLINER... cont'd

O.E.M #	Gabriel	Upgrade	O.E.M #	Gabriel	Upgrade	O.E.M #	Gabriel	Upgrade	O.E.M #	Gabriel	Upgrade
10-13211-000	85918	89449	16-17759-000	85919		471700131155	85918	89449	680009	85302	89420
10-13592-000	85959		16-18094-000	85959		471700131331	85932	89453	680017	85302	89420
10-13634-000	85918	89449	16-18705-000	85007	89412	471700131646	85918	89449	6803230200	85043	
10-13684-000	85918	89449	16-18706-000	85331		47902-13	83122	89406	6803230300	85006	
10-13759-000	85006		16-18707-000	85921		481700125969	85956		6803260000	83120	
10-13760-000	85959		16-18708-000	85724	89443	535228	85302	89420	680339	85724	89443
10-13776-000	85005	89430	16-18709-000	83134		58913-003	85932	89453	680442	85319	89428
10-13809-000	85958		16-18710-000	83134		58913-012	85932	89453	680511	85331	
10-13859-000	85005	89430	16-18711-000	85335		60680-004	83143		680611	85724	89443
10-13934-000	85123		16-19138-000	85058	89431	60680-005	83142		680651	85335	
16-10688-000	85042		3638112	G63183		61300224	85918	89449	680782	85302	89420
16-11133-000	85007	89412	4036892	G63605		61300240	85918	89449	681-323-0900	85009	
16-12117-000	85007	89412	471700000440	85959		650224	83225		681-323-1100	85301	
16-13947-000	85319	89428	471700000449	85918	89449	651352	85042		681-326-0400	85319	89428
16-13957-000	85724	89443	471700000470	85918	89449	654654	85043		6813230900	85009	
16-14259-000	85331		471700002391	85959		654875	83117		6813260000	83634	
16-14577-000	85043		471700002808	85724	89443	654918	83118		6813260200	85011	
16-14667-000	85005	89430	471700002809	85724	89443	659060	85920		70029	85308	89422
16-14668-000	83127		471700002990	85007	89412	659062	83134		70042	85302	89420
16-14669-000	G63403		471700002991	85959		659063	83134		90044162	83128	89436
16-14759-000	85000	89436	471700002992	85331		659300	85005	89430	90045083	85910	
16-15591-000	85043		471700002993	85921		660235	85042		GBL 651356	83634	
16-15765-000	85921		471700002994	83134		665174	85060		GBL654725	83120	
16-15770-000	85956		471700002995	83134		665236	85007	89412	GBL665538	85006	
16-15817-000	85724	89443	471700002996	85335		665409	85009		SDA471400003920	85958	
16-16442-000	83134		471700003009	85006		671908	85918	89449	SDA471700000440	85959	
16-16486-000	83134		471700003920	85958		671945	85920		SDA471700002809	85724	89443
16-16577-000	85335		471700006269	85932	89453	671946	85921		SDA471700002991	85959	
16-16765-000	85006		471700006929	85123		680008	85300	89419	SDA481700125969	85956	

FREIGHTLINER CAB SHOCKS

O.E.M #	Gabriel	Upgrade	O.E.M #	Gabriel	Upgrade	O.E.M #	Gabriel	Upgrade	O.E.M #	Gabriel	Upgrade
1201-0012	83023		18-30378	83006		18-60295-000	83006		654990	83038	
1201-0054	83021		18-30378-000	83001		18-60764-000	83038		659079	83040	
1201-1043	83025		18-31476-000	83020		18-60765-000	83038		659080	83039	
1201-1044	83025		18-32999-000	83001		18-60765-001	83047		659125	83047	
1202-0012	83023		18-32999-001	83006		18-60765-002	83038		659178	83038	
1202-0022	83046		18-37813-000	83044		18-60766-000	83040		659288	83006	
1202-0032	83016		18-41762-000	83038		18-60767-000	83039		681-891-02-05	83017	
1202-0042	83025		18-41762-001	83047		18-60768-000	83057		814903003482	83040	
1202-0043	83032		18-41762-002	83038		18-60769-000	83009		814903003483	83039	
1202-0044	83025		18-42613-000	83033		18-60772-000	83026		814903003484	83057	
1202-0054	83021		18-43504-000	83057		18-60773-000	83027		814903003486	83047	
1202-1043	83025		18-44321-000	83009		654739	83009		814903003496	83009	
1202-1044	83025		18-45067-000	83034		654819	83001		814903003528	83038	
18-29846-000	83009		18-47349-000	83039		654831	83006		GBL 650361	83017	
18-29846-001	83064		18-47350-000	83040		654841	83020				

FREIGHTLINER CUSTOM CHASSIS

O.E.M #	Gabriel	Upgrade	O.E.M #	Gabriel	Upgrade	O.E.M #	Gabriel	Upgrade	O.E.M #	Gabriel	Upgrade
10-13358-000	85097		141700131975	83160		16-15676-000	85058	89431	16-16093-000	83160	
10-13634-000	85918	89449	16-14794-000	83154		16-15705-000	83120		16-16262-000	83120	
10-13759-000	85006		16-15089-000	83164		16-15755-000	85043		16-16542-000	83154	
10-13859-000	85005	89430	16-15394-000	83120		16-15805-000	83120		16-16736-000	85029	
1398980	83127		16-15436-000	83154		16-15817-000	85724	89443	16-16737-000	83160	
141700000377	83174		16-15473-000	83157		16-15934-000	83120				
141700000378	83160		16-15474-000	83157		16-16043-000	85043				
141700131809	85029		16-15475-000	83164		16-16082-000	85043				
141700131810	83160		16-15592-000	83154		16-16083-000	85331				

Important Note: Competitive Interchanges are to be used for stocking purposes only. Where multiple crosses are identified, please reference the applications section of this catalog. / **Remarque importante:** Les interchanges concurrentiels ne s'utilisent qu'aux fins de stocks. Dans le cas de références multiples, consulter la section des applications du catalogue. / **Nota Importante:** Dans le cas de références multiples, consulter la section des applications du catalogue. / **Nota Importante:** Se pueden usar intercambios competitivos para propósitos de almacenamiento solamente. Cuando se identifican intercambios múltiples, consulte la sección de aplicaciones de este catálogo.

COMPETITIVE & O.E.M. INTERCHANGE LIST

Lista de Intercambios contra Competidores y Equipo Original.

Liste d'interchange de produits compétitifs & d'équipement original (OEM)

FREIGHTLINER CUSTOM CHASSIS... cont'd

O.E.M #	Gabriel	Upgrade	O.E.M #	Gabriel	Upgrade	O.E.M #	Gabriel	Upgrade	O.E.M #	Gabriel	Upgrade
16-16765-000	85006		16-18455-000	85918	89449	471700131775	85006		GBL 654870	83116	
16-16836-000	83154		16-18708-000	85724	89443	471700131974	85029		GBL654725	83120	
16-16873-000	85029		16-18713-000	85122		481700000477	85900		GBL654875	83117	
16-16874-000	83160		16-19138-000	85058	89431	481700000493	85900		GBL654918	83118	
16-17144-000	85900		1745500		89430	481700131919	85900		GBL665538	85006	
16-17361-000	85900		471700000447	85919		654918	83118		MAE 16949	83120	
16-17684-000	85058	89431	471700000466	85959		654953	85058	89431	MAE 16950	83118	
16-17759-000	85919		471700000467	85092		659104	85904		MAE16950	83118	
16-18075-000	83174		471700002726	85918	89449	659227	85058	89431	P116168	83117	
16-18076-000	83160		471700003009	85006		665545401		89430	P117099	83120	
16-18094-000	85959		471700003011	85058	89431	6803230300	85006		P117146	83118	
16-18095-000	85092		471700003070	85122		6803260000	83120		P117253	83116	
16-18103-000	85900		471700005079	85005	89430	GBL 651375	83119		RW24285	83119	

FRUEHAUF

O.E.M #	Gabriel	Upgrade	O.E.M #	Gabriel	Upgrade	O.E.M #	Gabriel	Upgrade	O.E.M #	Gabriel	Upgrade
144-5910	85300	89419	UCA-01113	85304		UCE-1295-901	85300	89419	UCF-8339-001	85321	
5116-117	83122	89406	UCA-5431	85305		UCE-2983-000	85322		UCF-8339-002	85321	
5352858	85305		UCD-006216-001	83203	89436	UCE-2983-001	85322		UEY 1124-001	85030	89440
680117	85300	89419	UCD-6216-1	83203	89436	UCE-2983-1	85322				
680298	85321		UCE-1295-1	85300	89419	UCE-9399-1	83122	89406			

FWD TRUCK

O.E.M #	Gabriel	Upgrade	O.E.M #	Gabriel	Upgrade	O.E.M #	Gabriel	Upgrade	O.E.M #	Gabriel	Upgrade
450739	85302	89420									

GENERAL TRAILER CO

O.E.M #	Gabriel	Upgrade	O.E.M #	Gabriel	Upgrade	O.E.M #	Gabriel	Upgrade	O.E.M #	Gabriel	Upgrade
120-1	83125		12608	83125							

GILLIG BROS.

O.E.M #	Gabriel	Upgrade	O.E.M #	Gabriel	Upgrade	O.E.M #	Gabriel	Upgrade	O.E.M #	Gabriel	Upgrade
1583470	85051		57113	83219		82-21542-000	85716		90044683	83122	89406
200-171	85304		57131	83216		82-30159-000	85708		90044769	83207	89407
53-02132	85723		665568	85051		90-1908	85723		90044770	83207	89407
53-02133-000	85318		680009	85302	89420	90-1951-SP1	85734		90045084	85968	
53-13952-000	85722		680333	85708		90-1968	85712		90F-1912	85318	
53-14005-000	85723		695109	85723		90-2164 SP1	85723		H53-02132-14005	85723	
53-14010	85318		695110	85318		90-2423	85723		H53-20415-006	85051	
53-176	85304		70034	85302	89420	90-2627		89461	MR6394	85723	
53-24685	85723		82-01878	83122	89406	90044046	83123	89405			

GMC TRUCK

O.E.M #	Gabriel	Upgrade	O.E.M #	Gabriel	Upgrade	O.E.M #	Gabriel	Upgrade	O.E.M #	Gabriel	Upgrade
1-51630-168-1	83515		1591501	85722		22012079	85701		22024673	85710	
1-51630-217-0	83114		15963161	83122	89406	22012082	85702		22025067	85704	
1-51630-217-1	83114		19152843	83136		22012083	85711		22025305	85704	
1-51630-219-1	83114		21998392	85336		22012083GS	85711		22045526	85702	
12474915	83122	89406	22002293	83126	89430	22012090	85308	89422	22046481	85702	
12474917	83137		22002294	83304		22012091	85303	89422	22046483	85304	
15123676	83136		22002295	83303		22012095	83126	89430	22046485	85710	
15174898	83136		22007701	83126	89430	22012096	83221		22046489	85303	89422
15174901	85342		22007702	83304		22012114	85700		22046499	85710	
15174902	85071		22007703	83303		22012131	85711		22052014	85702	
15174903	85342		22007750	83207	89407	22012166	83126	89430	22052336	85304	
15185643	83153		22007751	83303		22012169	83221		22052424	85710	
15185644	83155		22007752	83304		22012196	83221		22064230	83136	
15588554	83136		22007753	83303		22017530	83303		22064231	85324	
15642943	83136		22007757	83304		22017531	83303		22064232	85071	
15740554	83137		22012065	85304		22024061	85704		22064233	83136	
15887728	83136		22012067	85700		22024062	85701		22064432	85050	

Important Note: Competitive Interchanges are to be used for stocking purposes only. Where multiple crosses are identified, please reference the applications section of this catalog. / **Remarque importante:** Les interchanges concurrentiels ne s'utilisent qu'aux fins de stocks. Dans le cas de références multiples, consulter la section des applications du catalogue. / **Nota importante:** Dans le cas de références multiples, consulter la section des applications du catalogue. / **Nota importante:** Se pueden usar intercambios competitivos para propósitos de almacenamiento solamente. Cuando se identifican intercambios múltiples, consulte la sección de aplicaciones de este catálogo.

COMPETITIVE & O.E.M. INTERCHANGE LIST
Lista de Intercambios contra Competidores y Equipo Original.
Liste d'interchange de produits compétitifs & d'équipement original (OEM)

GMC TRUCK... cont'd

O.E.M #	Gabriel	Upgrade	O.E.M #	Gabriel	Upgrade	O.E.M #	Gabriel	Upgrade	O.E.M #	Gabriel	Upgrade
22064489	85336		4940662	83126	89430	5394467	85305		5554589	85307	
22064804	83136		4963844	85307		5394468	85735		5554596	85303	89422
22064805	83136		4963853	83216		5455798	85307		5554814	85302	89420
22064806	83136		4963854	83216		5513489	83216		5554959	83401	
22064807	83136		4964853	83217		5513716	85304		5554995	85305	
22065218	G63347		4974401	85700		5516459	85305		5559363	83203	89436
22065251	85030	89440	4975429	85300	89419	5522781	85735		5585939	85307	
22099889	85336		4975467	83207	89407	5522794	85308	89422	684280	83209	89414
2212169	83221		4975472	83161		5522818	85305		8-51630-666-0	85012	89413
22165187	83136		4975479	83400		5527001	85300	89419	8-94057-593-0	83114	
22165188	83136		4975480	83400		5527271	85700		8-94454-986-0	83515	
22165189	83136		4975494	83207	89407	5527272	85700		8-94454-987-0	83515	
22166442	83136		4975497	83126	89430	5527606	85305		8-97083-029-0	83515	
3082284	83400		4975501	85700		5531027	85301		8-97201-960-0	83515	
3166657	85700		4975510	83221		5531435	85307		8-97253-620-0	83515	
3171068	83216		4975511	83303		5531436	85307		8-97253664-0	83159	
3171069	85304		4975515	85701		5531437	85307		8-97253665-0	83159	
3171462	83126	89430	4975516	85702		5532026	85304		87-2520-00003	85704	
3171696	85307		4975518	85704		5532425	83207	89407	88963409	85336	
3172948	85303	89422	4975538	85700		5532433	83207	89407	88982682	83136	
3175509	85735		4975549	83216		5532675	85307		88982684	83136	
3178106	85700		4975550	85702		5533699	85302	89420	88982685	85342	
3178157	85700		4975552	85711		5534430	85303	89422	88982686	85071	
3178233	85734		4984526	83216		5534439	85304		88982687	85342	
3178507	85700		507-12	85701		5534447	85303	89422	88982688	85336	
3178995	85700		507-16	85702		5544060	85302	89420	898098-0580	83159	
3182842	85711		507-19	85700		5544112	83216		898098-0581	83159	
3188599	85711		507-22	85342		5544581	85302	89420	898098-0590	83159	
3188626	85300	89419	507-23	85342		5544716	85304		898098-1250	83515	
3188729	85303	89422	507-24	85336		5544717	85304		898098-1270	83515	
3189265	85700		508-88	83153		5544812	83308		9-51630-647-1	83515	
3192333	85700		508-89	83155		5544818	85735		9-51630-666-0	85012	89413
3192416	85711		5171068	83216		5549899	83207	89407	9-51630-666-2	85012	89413
3192657	83216		5304059	85700		5549924	85700		90044769	83207	89407
3192890	83126	89430	5316784	85700		5549925	85304		90044770	83207	89407
3192891	83221		5316791	83219		5552111	85304		94033786	83114	
3192892	83221		5316792	85305		5552112	85307		94051090	83114	
35901-0001	83209	89414	5316793	85305		5552114	83216		94057593	83114	
35901-0003	85301		5316794	85700		5552205	83217		94454987	83515	
35901-0004	83219		5316984	85313		5552206	83214		97-2210-00153	85701	
35901-0005	83219		5321920	85307		5552207	83217		97-2210-00156	85702	
35901-0017	83314		5321929	85307		5552208	83217		97-2210-00164	85708	
37301-0016	85026	89417	5348631	83203	89436	5552209	83215		97-2210-00170	85733	
37301-0021	85026	89417	5352857	85700		5552210	85308	89422	97083027	83515	
37301-3202	85026	89417	5352858	85305		5552244	85308	89422	97083029	83515	
4939852	85308	89422	5353054	85303	89422	5552285	83214		97201960	83515	
4939967	85308	89422	5355798	85307		5552286	83217		97253616	83515	
4940600	83209	89414	5357955	85300	89419	5552287	83217		97253620	83515	
4940601	83216		5357956	85734		5552288	83217		97253621	83515	
4940606	83126	89430	5357959	85300	89419	5552451	85308	89422	97253623	83515	
4940614	83216		5361994	85734		5552452	85303	89422	97253651	83404	
4940627	83203	89436	5374779	85308	89422	5552453	85301		97253664	83159	
4940640	83216		5374999	85307		5552454	85302	89420	97253665	83159	
4940650	83207	89407	5385939	85307		5552456	85307		98098058	83159	
4940654	83216		5392387	85303	89422	5552527	85735		98098059	83159	
4940660	83207	89407	5394448	85305		5554184	85302	89420	98098125	83515	

Important Note: Competitive Interchanges are to be used for stocking purposes only. Where multiple crosses are identified, please reference the applications section of this catalog. / **Remarque importante:** Les interchanges concurrentiels ne s'utilisent qu'aux fins de stocks. Dans le cas de références multiples, consulter la section des applications du catalogue. / **Nota importante:** En el caso de referencias múltiples, consultar la sección de aplicaciones del catálogo. / **Nota importante:** Se pueden usar intercambios competitivos para propósitos de almacenamiento solamente. Cuando se identifican intercambios múltiples, consulte la sección de aplicaciones de este catálogo.

COMPETITIVE & O.E.M. INTERCHANGE LIST

Lista de Intercambios contra Competidores y Equipo Original.

Liste d'interchange de produits compétitifs & d'équipement original (OEM)

GMC TRUCK... cont'd

O.E.M #	Gabriel	Upgrade	O.E.M #	Gabriel	Upgrade	O.E.M #	Gabriel	Upgrade	O.E.M #	Gabriel	Upgrade
98098127	83515		98232671	83515		L-12706	83155		U0109-014	83400	

GMC TRUCK CAB SHOCKS

O.E.M #	Gabriel	Upgrade	O.E.M #	Gabriel	Upgrade	O.E.M #	Gabriel	Upgrade	O.E.M #	Gabriel	Upgrade
1201-1043	83025		1202-0022	83046		1202-0054	83021				
1202-0012	83023		1202-0032	83016		1202-1043	83025				

GRANNING SUSPENSION

O.E.M #	Gabriel	Upgrade	O.E.M #	Gabriel	Upgrade	O.E.M #	Gabriel	Upgrade	O.E.M #	Gabriel	Upgrade
1085	83214		680162	85300	89419	OE12425	83214				
2697	85712		701071-01	646155							

GREAT DANE TRAILER

O.E.M #	Gabriel	Upgrade	O.E.M #	Gabriel	Upgrade	O.E.M #	Gabriel	Upgrade	O.E.M #	Gabriel	Upgrade
18163-01	83207	89407	HENS-20002	85000	89436	HENS-23649	85064		REY18165-01	85006	
18164-01	83122	89406	HENS-20126	85323	89436	HENS-24088	83128	89436			
18165-01	85006		HENS-21292	85052		HENS-24088	85000	89436			
HENS-20001	83128	89436	HENS-23566	85000	89436	MER202447	85919				

GREYHOUND BUS

O.E.M #	Gabriel	Upgrade	O.E.M #	Gabriel	Upgrade	O.E.M #	Gabriel	Upgrade	O.E.M #	Gabriel	Upgrade
12B-5-1	85735		3166657	85700		3178157	85700		690029	85700	
12TA-01-013	85303	89422	3178154	85735		3192333	85700		74413	85313	

GRUMMAN BUS

O.E.M #	Gabriel	Upgrade	O.E.M #	Gabriel	Upgrade	O.E.M #	Gabriel	Upgrade	O.E.M #	Gabriel	Upgrade
22024506	85703		690029	85700		97-2201-00004	85703		97-2210-00003	85704	
22025066	85703		97-2201-00001	85703		97-2201-00005	85703		97-2210-00004	85704	
22025067	85704		97-2201-00002	85703		97-2210-00001	85704		97-2210-00005	85704	
22025305	85704		97-2201-00003	85703		97-2210-00002	85704				

GULF STREAM COACH

O.E.M #	Gabriel	Upgrade	O.E.M #	Gabriel	Upgrade	O.E.M #	Gabriel	Upgrade	O.E.M #	Gabriel	Upgrade
141700131809	85029		16-16736-000	85029		16-16873-000	85029		16-18103-000	85900	
141700131810	83160		16-16737-000	83160		16-16874-000	83160		481700000493	85900	

HARDEE MFG

O.E.M #	Gabriel	Upgrade	O.E.M #	Gabriel	Upgrade	O.E.M #	Gabriel	Upgrade	O.E.M #	Gabriel	Upgrade
8030223	83207	89407	AS789B	85014							

HAUSMAN

O.E.M #	Gabriel	Upgrade	O.E.M #	Gabriel	Upgrade	O.E.M #	Gabriel	Upgrade	O.E.M #	Gabriel	Upgrade
695110	85318		695119	85702		695198	85706				

HENDRICKSON TRAILER SUSPENSION SYSTEMS

O.E.M #	Gabriel	Upgrade	O.E.M #	Gabriel	Upgrade	O.E.M #	Gabriel	Upgrade	O.E.M #	Gabriel	Upgrade
57905-2	85006		665759	85052		680571	85738		A-20001	83128	89436
60675-004	85006		665760	85045		680573	85939		A-20002	85000	89436
654951	85000	89436	665761	85911		680579	85939		A-20126	85323	89436
659024	85052		665763	85079		680614	85338		A-20345	85345	
665190	85006		665764	85029		680616		89430	A-20886	85030	89440
665246	85043		665765	83150		680617	85337		A-20887	85005	89430
665267	85029		665766	85000	89436	680702	85323	89436	A-20889	85323	89436
665405	85030	89440	665767	85045		680756	85323	89436	A-21292	85052	
665406	85010		671779		89414	680769	85911		A-2160	85014	
665531	85000	89436	671948	85000	89436	680776	85338		A-2212	85029	
665532	85013	89414	680102	85712		98583-019	85323	89436	A-2213	85010	
665533	85005	89430	680341	85323	89436	98583-020		89414	A-2218	85030	89440
665536	85000	89436	680463		89440	A-10023	85000	89436	A-2230	85005	89430
665693	85064		680467	85323	89436	A-10348	85043		A-2232	85005	89430
665694	85052		680509	85738		A-11931	85000	89436	A-2240	85013	89414
665698	85911		680565	85738		A-14496	646155		A-2240-1	85043	
665733	85045		680566	85938		A-14583	85000	89436	A-2471	85006	
665756	85000	89436	680568	85323	89436	A-1667	85000	89436	A-4084	85005	89430
665758	85064		680570		89437	A-1668	85000	89436	A-4089	83209	89414

Important Note: Competitive Interchanges are to be used for stocking purposes only. Where multiple crosses are identified, please reference the applications section of this catalog. / **Remarque importante:** Les interchanges concurrentiels ne s'utilisent qu'aux fins de stocks. Dans le cas de références multiples, consulter la section des applications du catalogue. / **Nota importante:** Dans le cas de références multiples, consulter la section des applications du catalogue. / **Nota importante:** Se pueden usar intercambios competitivos para propósitos de almacenamiento solamente. Cuando se identifican intercambios múltiples, consulte la sección de aplicaciones de este catálogo.

COMPETITIVE & O.E.M. INTERCHANGE LIST
Lista de Intercambios contra Competidores y Equipo Original.
Liste d'interchange de produits compétitifs & d'équipement original (OEM)

HENDRICKSON TRAILER SUSPENSION SYSTEMS... cont'd

O.E.M #	Gabriel	Upgrade	O.E.M #	Gabriel	Upgrade	O.E.M #	Gabriel	Upgrade	O.E.M #	Gabriel	Upgrade
A-4890	85712		B-23743	85938		S-20886	85030	89440	S-23548	85079	
A-6156	85301		B-23744	85344		S-20887	85005	89430	S-23566	85000	89436
B-20345	85345		B-24023	85738		S-20889	85323	89436	S-23649	85064	
B-21553	85738		B-24088	83128	89436	S-21292	85052		S-23650	85052	
B-21699	87018		B-24088	85000	89436	S-21553	85738		S-23651	85045	
B-21832	85323	89436	B-24125	85323	89436	S-2160	85014		S-23743	85938	
B-21936	85064		B-24579	85939		S-21699	87018		S-23744	85344	
B-21947	85052		B-25174	85029		S-21832	85323	89436	S-24023	85738	
B-21994	85938		B-25436	85916	89430	S-21936	85064		S-24088	83128	89436
B-21995	85344		B-25437	85337		S-21947	85052		S-24088	85000	89436
B-22311	85045		B-25515	85338		S-2212	85029		S-24125	85323	89436
B-22312	85939		B-26652	85000	89436	S-2213	85010		S-24579	85939	
B-22345	85911		B-27058	83128		S-2218	85030	89440	S-2471	85006	
B-22715	85000	89436	B-27747	85911		S-2230	85005	89430	S-25436	85916	89430
B-22862	85045		B-29432	85323	89436	S-22311	85045		S-25437	85337	
B-23013	85000	89436	B-29678	85911		S-22312	85939		S-25515	85338	
B-23014	85738		B-29826	85338		S-2232	85005	89430	S-26652	85000	89436
B-23290	83150		B-33312	85338		S-22345	85911		S-29432	85323	89436
B-23315	85029		B-33313	85338		S-2240	85013	89414	S-29678	85911	
B-23316	85382		NS500699	85005	89430	S-22715	85000	89436	S-29826	85338	
B-23361	85911		S-10348	85043		S-22862	85045		S-33312	85338	
B-23362		89437	S-14583	85000	89436	S-23013	85000	89436	S-33313	85338	
B-23548	85079		S-1667	85000	89436	S-23014	85738		S-33313L	85338	
B-23566	85000		S-1668	85000	89436	S-23290	83150		S-4084	85005	89430
B-23566	85000	89436	S-20001	83128	89436	S-23315	85029		S-4089	83209	89414
B-23649	85064		S-20002	85000	89436	S-23316	85382		S-4890	85712	
B-23650	85052		S-20126	85323	89436	S-23361	85911				
B-23651	85045		S-20345	85345		S-23362		89437			

HENDRICKSON TRUCK SUSPENSION SYSTEMS

O.E.M #	Gabriel	Upgrade	O.E.M #	Gabriel	Upgrade	O.E.M #	Gabriel	Upgrade	O.E.M #	Gabriel	Upgrade
12738	83225		57241-006	83111		60657-005	85087		60670-008L	83123	89405
471700000456	85959		57324-1	85036	89405	60657-006	85102		60670-009	85013	89414
471700006269	85932	89453	57324-11	85305		60657-007	85072		60670-010	83149	
471700131545	85006		57324-2	85976		60657-010	85102		60670-011	83148	
47902-11	83207	89407	57324-3	85916		60657-011	85102		60670-012	83168	
47902-13	83122	89406	57324-5	85903		60665-003	83137		60670-013	83148	
47902-15	83137		57324-6	85904		60665-004	85036	89405	60670-014	83166	
47902-18	85030	89440	57905-1	85976		60665-005	85919		60670-017	83148	
47902-19	83123	89405	58623-1	85978		60665-008	85978		60670-018	83166	
47902-20	85036	89405	58913-003	85932	89453	60665-009	85904		60670-019	83166	
47902-21	85976		58913-007	85959		60665-011	85967		60670-020	83148	
47902-22	85916		58913-007L	85959		60665-013	85965		60670-12	83168	
47902-24	83137		58913-008	85959		60665-014	85962		60675-001	85978	
47902-25	83125		58913-008L	85959		60665-015	85966		60675-002	85979	
47902-26	83144		58913-009	85959		60665-018	85961		60675-003	85976	
47902-27	83123	89405	58913-009L	85959		60665-020	85919		60675-005	85980	
47902-28	85013	89414	58913-011	85959		60665-024	85903		60675-006	85909	
47902-29	83149		58913-012	85932	89453	60665-025	85036		60675-014	85978	
47902-3	85005	89430	59048-001	83148		60670-001	83123	89405	60675-8Q	85976	
47902-8	83122	89406	59057-001	83137		60670-001	85036	89405	60680-001	83111	
47902-9	83123	89405	59057-002	85036	89405	60670-002	83207	89407	60680-002	83109	
503610C2	83207	89407	59305-1	85979		60670-003	83149		60680-003	83112	
5554596	85303	89422	59483-000	85919		60670-004	83123	89405	60680-004	83143	
57241-001	83111		59851-1	85976		60670-005	83137				
57241-002	83109		59852-1	85977		60670-006	83147				
57241-003	83112		59852-2	85977		60670-007	83144				
57241-004	83110		60657-003	85072		60670-008	83123	89405			

Important Note: Competitive Interchanges are to be used for stocking purposes only. Where multiple crosses are identified, please reference the applications section of this catalog. / **Remarque importante:** Les interchanges concurrentiels ne s'utilisent qu'aux fins de stocks. Dans le cas de références multiples, consulter la section des applications du catalogue. / **Nota importante:** Dans le cas de références multiples, consulter la section des applications du catalogue. / **Nota importante:** Se pueden usar intercambios competitivos para propósitos de almacenamiento solamente. Cuando se identifican intercambios múltiples, consulte la sección de aplicaciones de este catálogo.

COMPETITIVE & O.E.M. INTERCHANGE LIST
Lista de Intercambios contra Competidores y Equipo Original.
Liste d'interchange de produits compétitifs & d'équipement original (OEM)

HENDRICKSON TRUCK SUSPENSION SYSTEMS... cont'd

O.E.M #	Gabriel	Upgrade	O.E.M #	Gabriel	Upgrade	O.E.M #	Gabriel	Upgrade	O.E.M #	Gabriel	Upgrade
60680-005	83142		654896	83147		65992-003	85959		671798	85962	
60680-009	85083		654897	83144		65992-006	85986		672009	85903	
60680-012	85083		654898	83123	89405	665816	85072		680091	85303	89422
60685-001	85977		654899	85013	89414	665892	85072		680600	85305	
60998-001	85006		654900	83149		671006	85036	89405	70018	85303	89422
60998-002	85919		654903	83111		671007	83137		70021	85303	89422
60998-003	85006		654904	83109		671009	85919		70088	85307	
64838-001	85933	89454	654905	83112		671030	85083		98583-005	83168	
64838-001L	85933	89454	659000	83148		671063	85083		98583-006	83148	
64838-002	85933	89454	659004	83123	89405	671105	85072		98583-016	83147	
64838-002L	85933	89454	659048	83143		671603	85919		98583-032	85072	
64838-003	85933	89454	659049	83142		671606	85955		AE76164-3	85307	
64838-003L	85933	89454	659155	83147		671611	85955		AE76164-4	83225	
654890	83207	89407	659202	83148		671704	85904		BE76164-2	85303	89422
654891	83149		659292	83148		671764	85967		BE76164-3	85307	
654894	83123	89405	65992-001	85955		671792	85965		BE76164-4	83225	
654895	83137		65992-002	85955		671793	85966				

HIGHWAY PRODUCT

O.E.M #	Gabriel	Upgrade	O.E.M #	Gabriel	Upgrade	O.E.M #	Gabriel	Upgrade	O.E.M #	Gabriel	Upgrade
A1-6-134	83207	89407	A1-6-135	83203	89436						

HINO

O.E.M #	Gabriel	Upgrade	O.E.M #	Gabriel	Upgrade	O.E.M #	Gabriel	Upgrade	O.E.M #	Gabriel	Upgrade
34802	83216		48511-80162	83518		48530-3280	G63440		S4850-01941	83141	
48500-1800	83216		48530-1120	83104		48530E0100	83166		S4850-01950	G63610	
48500-1801	83216		48530-1460	83215		48531-37361	83519		S4850-02750	G63610	
48500-1940	83141		48530-1620	83104		48531-37362	83519		S4850-03710	83126	89430
48500-1941	83141		48530-1770	83215		60670-012	83168		S4850-03720	83140	
48500-1950	G63610		48530-1880	83362		60670-013	83148		S4853-01900	83104	
48500-2750	G63610		48530-1890	83104		60670-014	83166		S4853-01910	83216	
48500-3710	83126	89430	48530-1900	83104		60670-018	83166		S4853-02510	83216	
48500-3720	83140		48530-1910	83216		60670-019	83166		S4853-03280	G63440	
485003710A	83126	89430	48530-2050	83217		60670-020	83148				
48511-37320	83518		48530-2510	83216		66639	G63610				

HOBBS TRAILERS

O.E.M #	Gabriel	Upgrade	O.E.M #	Gabriel	Upgrade	O.E.M #	Gabriel	Upgrade	O.E.M #	Gabriel	Upgrade
680117	85300	89419									

HOLIDAY RAMBLER

O.E.M #	Gabriel	Upgrade	O.E.M #	Gabriel	Upgrade	O.E.M #	Gabriel	Upgrade	O.E.M #	Gabriel	Upgrade
90044794	83127		U0109-007	G63183							

HOLLAND - BINKLEY

O.E.M #	Gabriel	Upgrade	O.E.M #	Gabriel	Upgrade	O.E.M #	Gabriel	Upgrade	O.E.M #	Gabriel	Upgrade
680298	85321		6898	83125							

HUTCHENS SUSPENSION

O.E.M #	Gabriel	Upgrade	O.E.M #	Gabriel	Upgrade	O.E.M #	Gabriel	Upgrade	O.E.M #	Gabriel	Upgrade
9423-00	83203	89436									

HYSTER

O.E.M #	Gabriel	Upgrade	O.E.M #	Gabriel	Upgrade	O.E.M #	Gabriel	Upgrade	O.E.M #	Gabriel	Upgrade
650150	83217		73516	83217							

IC CORPORATION

O.E.M #	Gabriel	Upgrade	O.E.M #	Gabriel	Upgrade	O.E.M #	Gabriel	Upgrade	O.E.M #	Gabriel	Upgrade
2200327C1	85332		3601600C3	85082		3902993C3	83135		65992-006	85986	
3533356C3	83169		3604282C1	85351		472412C91	83456	89447	OE13402S	83163	
3578105C1	83163		3605735C1	83156		501906C91	83317		OE13424S	83317	
3578105C2	83163		3605735C2	83156		501906C92	83317				
3578858C2	85926		3902993C2	83135		6127088C1	83163				

Important Note: Competitive Interchanges are to be used for stocking purposes only. Where multiple crosses are identified, please reference the applications section of this catalog. / **Remarque importante:** Les interchanges concurrentiels ne s'utilisent qu'aux fins de stocks. Dans le cas de références multiples, consulter la section des applications du catalogue. / **Nota importante:** Dans le cas de références multiples, consulter la section des applications du catalogue. / **Nota importante:** Se pueden usar intercambios competitivos para propósitos de almacenamiento solamente. Cuando se identifican intercambios múltiples, consulte la sección de aplicaciones de este catálogo.

COMPETITIVE & O.E.M. INTERCHANGE LIST

Lista de Intercambios contra Competidores y Equipo Original.

Liste d'interchange de produits compétitifs & d'équipement original (OEM)

INGERSALL MACHINE

O.E.M #	Gabriel	Upgrade	O.E.M #	Gabriel	Upgrade	O.E.M #	Gabriel	Upgrade	O.E.M #	Gabriel	Upgrade
665472			665904								

INGERSOLL AXLES

O.E.M #	Gabriel	Upgrade	O.E.M #	Gabriel	Upgrade	O.E.M #	Gabriel	Upgrade	O.E.M #	Gabriel	Upgrade
653511-01	85323	89436	653511-02	85938		653511-03	85045		653511-04	85052	

INTERNATIONAL (NAVISTAR)

O.E.M #	Gabriel	Upgrade	O.E.M #	Gabriel	Upgrade	O.E.M #	Gabriel	Upgrade	O.E.M #	Gabriel	Upgrade
1660846C91	83101		308650C92	83216		3584116C2	83175		3737576C1	85931	89458
1660846C92	83101		308664C91	85307		3584117C1	83135		3806341C3	85995	
1663471C1	83103		308668C91	85012	89413	3584117C2	83135		3810581C3	85995	
1663606C91	85027	89418	308668C92	85012	89413	3584118C1	85928		3810581C4	85995	
1664149C1	85029		308669C91	85012	89413	3584118C2	85928		3812837C1	85954	
1664524C1	85935		320444C91	85012	89413	3584535C1	85924	89457	3813340C1	85964	
1664788C2	85316	89426	329316C92	85012	89413	3584535C2	85924	89457	3813340C2	85964	
1667520C1	85058	89431	350425C1	85300	89419	3584535C3	85924	89457	3813340C3	85964	
1675455C1	85003	89411	350426C1	85734		3586883C1	85931	89458	3813341C1	85963	
1675496C91	83636		350426C91	85734		3586902C2	83146		3813341C2	85963	
1675496C92	83636		3514952C1	85976		3588209C1	85957		3813341C3	85963	
1677707C1	85030	89440	3533356C1	83135		3588209C2	85957		3816234C1	85999	
1690035C1	85003	89411	3533356C2	83135		3588591C1	85953		3819277C1	85969	
2015556C1	85316	89426	3533356C3	83169		3588591C2	85953		3819279C1	85969	
2015557C1	85030	89440	3533357C1	85957		3588592C1	85953		3821760C1	85931	89458
2018987C1	85003	89411	3533357C2	85957		3588592C2	85953		383379C91	83308	
2018987C2	85003	89411	3533357C3	85957		3596107C1	85927		384435C91	83216	
2029200C91	83126	89430	3541456C1	85929		3596107C2	85927		3868264C1	85998	
2029200C91	85030	89440	3544766C1	85930		3601600C1	85082		3892445C3	85931	89458
2032533C1	85316	89426	3544768C1	85926		3601600C2	85082		3902993C1	83167	
2039549C1	85333		3549099C1	85923	89458	3601600C3	85082		3902993C3	83135	
2039565C1	83100		3549099C2	85923	89458	3604282C1	85351		3945165C1	83180	
204994R91	83225		3549100C1	85926		360444C91	85012	89413	4050340C1	85931	89458
206620R91	83216		3553628C1	85927		3605735C1	83156		4050340C2	85931	89458
206621R91	83216		3553628C2	85927		3605735C2	83156		4070336C1	85058	89431
206621R92	83216		3553628C3	85927		3606770C1	83163		426744R91	85303	89422
208664C91	85307		3558089C1	85925		3606770C2	83163		426744R92	85303	89422
210533R91	83225		3558089C2	85925		3606857C1	85954		446-51-211	85739	
210534R92	83225		3558089C3	85925		3606857C2	85954		452566C91	83225	
210535R91	83225		3558989C1	85925		3606857C3	85994		453527C91	85311	89424
210536R91	83225		3558989C2	85925		3606859C1	85954		453528C91	85311	89424
210537R91	83225		3571711C1	85316	89426	3606859C2	85954		453531C91	G63306	
210538R91	83225		3571713C1	85333		3606859C3	85994		453556C91	85012	89413
210918R91	83215		3573265C1	85931	89458	3609178C1	85955		453557C91	G63306	
210919R91	85307		3576464C1	85957		3609400C1	83317		453561C91	83225	
210920R91	85308	89422	3576464C2	85957		3609400C2	83317		453562C91	83225	
2200327C1	85332		3576465C2	85999		3610198C1	85963		453564C91	85012	89413
287318C91	G63306		3578105C1	83163		3610199C1	85964		453565C91	83225	
288920C91	83225		3578105C2	83163		3613984C1	85955		453566C91	83225	
288921C91	83225		3578858C1	85926		3620395C1	85931	89458	453567C91	83216	
288921R92	83225		3578858C2	85926		3626571C1	85072		453568C91	83225	
293009C91	85308	89422	3581106C1	85924	89457	3660548C1	85955		453569C91	83225	
294334C91	83216		3581106C2	85924	89457	3660549C1	85955		453570C91	83216	
3000070C91	83456	89447	3581106C3	85924	89457	3668566C1	85954		453571C91	83216	
3000098C1	83317		3581107C1	85924	89457	3670156C1	85954		453572C91	83309	89446
306444C91	85012	89413	3581107C2	85924	89457	3674348C1	85954		453574C91	85307	
3085640C92	83216		3581107C3	85924	89457	3688614C1	85923	89458	453575C91	83308	
308646C91	85012	89413	3581109C1	85924	89457	3688616C1	85923	89458			
308648C91	83225		3581109C3	85924	89457	3688729C1	85931	89458			
308649C91	83216		3581109C4	85924	89457	3688732C1	85931	89458			
308650C91	83216		3584116C1	83175		3737575C1	85954				

Important Note: Competitive Interchanges are to be used for stocking purposes only. Where multiple crosses are identified, please reference the applications section of this catalog. / **Remarque importante:** Les interchanges concurrentiels ne s'utilisent qu'aux fins de stocks. Dans le cas de références multiples, consulter la section des applications du catalogue. / **Nota importante:** Dans le cas de références multiples, consulter la section des applications du catalogue. / **Nota importante:** Se pueden usar intercambios competitivos para propósitos de almacenamiento solamente. Cuando se identifican intercambios múltiples, consulte la sección de aplicaciones de este catálogo.

COMPETITIVE & O.E.M. INTERCHANGE LIST
Lista de Intercambios contra Competidores y Equipo Original.
Liste d'interchange de produits compétitifs & d'équipement original (OEM)

INTERNATIONAL (NAVISTAR)... cont'd

O.E.M #	Gabriel	Upgrade	O.E.M #	Gabriel	Upgrade	O.E.M #	Gabriel	Upgrade	O.E.M #	Gabriel	Upgrade
453576C91	85303	89422	4C4Z-18124-N	85957		596329C1	85014		90044626	83126	89430
453576C92	85303	89422	4C4Z-18125-DA	85926		60657-003	85072		AMS 600102	85005	89430
453577C91	85308	89422	501506C91	83317		60657-006	85102		AMS 600172	83126	89430
453579C91	85308	89422	501553C91	85003	89411	60657-010	85102		AMS 600172	85030	89440
453597C91	83216		501905C91	83301		60657-011	85102		AMS 650420	85013	89414
462557C91	85300	89419	501906C91	83317		60670-007	83144		AMS650102	85001	89410
462603C91	85705	89447	501906C92	83317		60675-003	85976		AMS650107	85316	89426
462753C91	83216		503550C1	83207	89407	60680-003	83112		AMS650400	85033	89427
463926C91	85705	89447	503610C1	83207	89407	60680-004	83143		AMS650402	85311	89424
467371C91	83225		503610C2	83207	89407	6127088C1	83163		AMS650404	85310	89423
467372C91	83225		507202C1	85030	89440	65992-001	85955		AMS650405	85023	89415
467980C91	G63306		534464C1	85734		65992-002	85955		AMS650406	85024	89416
467983C91	85012	89413	537524C91	83123	89405	66400	G63432		AMS650408	85319	89428
467984C91	83216		537525C91	83123	89405	6E7Z-18125-A	83146		AMS650420	85013	89414
467985C91	85012	89413	540395C91	83613		70334	85316	89426	H60657-003	85072	
471201C91	85012	89413	540395C92	83613		790335C91	83209	89414	H60657-006	85102	
471203C91	83308		548532C1	83103		800670	85060		H60657-010	85102	
472367C91	83318		56101 Z1030	85311	89424	873619C92	83314		H60657-011	85102	
472411C91	83456	89447	56101 Z2000	85311	89424	873619C93	83314		H60675-003	85976	
472412C91	83456	89447	56101 Z5008	83114		873622C91	83308		OE 18513	83135	
472414C91	83318		56101 Z5011	G63610		874695R91	85012	89413	OE13402S	83163	
474002C91	83308		56110-T8123	G63432		874695R92	85012	89413	OE13424S	83317	
477132C1	85303	89422	56110-T8129	G63432		874696R91	85012	89413	OE17103	83167	
47902-24	83137		586724C91	83456	89447	90044025	83209	89414			

INTERNATIONAL (NAVISTAR) CAB SHOCKS

O.E.M #	Gabriel	Upgrade	O.E.M #	Gabriel	Upgrade	O.E.M #	Gabriel	Upgrade	O.E.M #	Gabriel	Upgrade
1201-0012	83023		1201-9018	83062		2500013C1	83013		2597458C91	83062	
1201-0154	83051		1201-9021	83062		2503529C1	83025		2600491C91	83062	
1201-0254	83051		1202-0012	83023		2507409C1	83052		2601488C91	83062	
1201-1043	83025		1202-0022	83046		2507761C1	83052		2602021C1	83062	
1201-1044	83025		1202-0032	83016		2507763C1	83052		3557165C1	83053	
1201-1049	83025		1202-0042	83025		2507948C1	83054		3557166C1	83052	
1201-1212	83013		1202-0043	83032		2508326C1	83021		3557167C3	83053	
1201-1213	83005		1202-0044	83025		2508327C1	83025		3557169C1	83052	
1201-9001	83052		1202-0054	83021		2509221C91	83054		3557169C2	83052	
1201-9002	83052		1202-1043	83025		2509222C91	83053		3560649C1	83052	
1201-9003	83052		1202-1044	83025		2509223C91	83054		3560649C2	83052	
1201-9007	83054		1202-1212	83013		2509224C91	83053		3560705C2	83054	
1201-9008	83054		1202-1213	83005		2585145C1	83051		480945C1	83014	
1201-9009	83054		2012768C1	83013		2589922C1	83051		480945C2	83014	
1201-9010	83053		2012769C2	83005		2590915C1	83062		AMS66160	83052	
1201-9011	83053		2023684C1	83015		2590916C1	83062		AMS66161	83053	
1201-9013	83062		2023685C1	83015		2593803C91	83062		OE14771	83062	
1201-9014	83062		2025790C1	83013		2595314C1	83062				

ISUZU

O.E.M #	Gabriel	Upgrade	O.E.M #	Gabriel	Upgrade	O.E.M #	Gabriel	Upgrade	O.E.M #	Gabriel	Upgrade
1-51630-168-1	83515		51630219	83114		8-22064-807-0	83136		8-97253-623-0	83515	
1-51630-217-0	83114		51630647	83515		8-51630-666-0	85012	89413	8-97253-651-2	83404	
1-51630-217-1	83114		51630666	85012	89413	8-94454-647-1	83515		8-97253-664-0	83159	
1-51630-219-1	83114		60670-005	83137		8-94454-986-0	83515		8-97253-665-0	83159	
12474915	83122	89406	8-22064-231-0	85324		8-94454-987-0	83515		8-98098-058-0	83159	
15123676	83136		8-22064-232-0	85071		8-97083-027-0	83515		8-98098-058-1	83159	
15174902	85071		8-22064-233-0	83136		8-97083-029-0	83515		8-98098-059-0	83159	
15887728	83136		8-22064-489-0	85336		8-97253-616-0	83515				
19152843	83136		8-22064-804-0	83136		8-97253-620-0	83515				
51630168	G63610		8-22064-805-0	83136		8-97253-620-1	83515				
51630217	83114		8-22064-806-0	83136		8-97253-621-0	83515				

Important Note: Competitive Interchanges are to be used for stocking purposes only. Where multiple crosses are identified, please reference the applications section of this catalog. / **Remarque importante:** Les interchanges concurrentiels ne s'utilisent qu'aux fins de stocks. Dans le cas de références multiples, consulter la section des applications du catalogue. / **Nota importante:** Dans le cas de références multiples, consulter la section des applications du catalogue. / **Nota importante:** Se pueden usar intercambios competitivos para propósitos de almacenamiento solamente. Cuando se identifican intercambios múltiples, consulte la sección de aplicaciones de este catálogo.

COMPETITIVE & O.E.M. INTERCHANGE LIST

Lista de Intercambios contra Competidores y Equipo Original.

Liste d'interchange de produits compétitifs & d'équipement original (OEM)

ISUZU... cont'd

O.E.M #	Gabriel	Upgrade	O.E.M #	Gabriel	Upgrade	O.E.M #	Gabriel	Upgrade	O.E.M #	Gabriel	Upgrade
8-98098-125-0	83515		898098-1250	83515		94033786	83114		97253664	83159	
8-98098-127-0	83515		898098-1270	83515		94454986	83515		97253665	83159	
8-98098059-0	83159		8982326710	83515		94454987	83515		98098058	83159	
88982682	83136		8982326720	83515		97083027	83515		98098059	83159	
88982686	85071		9-51630-647-1	83515		97083029	83515		98098125	83515	
8972019600	83515		9-51630-666-0	85012	89413	97253620	83515		98098127	83515	
898098-0581	83159		9-51630-666-2	85012	89413	97253651	83404				

ITASCA

O.E.M #	Gabriel	Upgrade	O.E.M #	Gabriel	Upgrade	O.E.M #	Gabriel	Upgrade	O.E.M #	Gabriel	Upgrade
141700131809	85029		16-16873-000	85029		24-153256	85124		F4-BE5-F325-HO	85124	
141700131810	83160		16-16874-000	83160		481700000493	85900		W0005662	85125	
16-16736-000	85029		16-18103-000	85900		F4-BE5-A832-MO	85125		W0005663	85124	
16-16737-000	83160		24-153249	85125		F4-BE5-F324-HO	85125		W0006254	85125	

JAY MADSEN

O.E.M #	Gabriel	Upgrade	O.E.M #	Gabriel	Upgrade	O.E.M #	Gabriel	Upgrade	O.E.M #	Gabriel	Upgrade
3166657	85700		3192333	85700							

JIFFLOX

O.E.M #	Gabriel	Upgrade	O.E.M #	Gabriel	Upgrade	O.E.M #	Gabriel	Upgrade	O.E.M #	Gabriel	Upgrade
CP-5222	85315										

JOHN DEERE

O.E.M #	Gabriel	Upgrade	O.E.M #	Gabriel	Upgrade	O.E.M #	Gabriel	Upgrade	O.E.M #	Gabriel	Upgrade
3638112	G63183		4036892	G63605							

KENWORTH

O.E.M #	Gabriel	Upgrade	O.E.M #	Gabriel	Upgrade	O.E.M #	Gabriel	Upgrade	O.E.M #	Gabriel	Upgrade
02-02736PLUS	85302	89420	665331	83353		671794	85067	89451	90045099	85906	89407
02-02737PLUS	85062	89408	665453	85001	89410	671962	85936	89456	90045132	85909	
02-02738PLUS	85012	89413	665565	85007	89412	671962PLUS	85936	89456	90045605	85109	
02-02739PLUS	85013	89414	665565PLUS	85007	89412	671963	85937		ACHB966	83136	
03-04176PLUS	85308	89422	665617	85031		675041	83353		B71-1000	85031	
03-06084PLUS	85033	89427	665632	85013	89414	675122	85001	89410	B71-1001	85070	89459
03-07421PLUS	85311	89424	665633	85033	89427	680237	85303	89422	B71-1002	85001	89410
03-07423PLUS	85033	89427	665670	85001	89410	680239	85310	89423	B71-1003	83312	89409
10-12032-002PLUS	85320	89429	665680	83312	89409	680240	85302	89420	B71-6000	85959	
10-12542-000PLUS	85901		665783	83123	89405	680241	85311	89424	B71-6002	85012	89413
16-13947-000PLUS	85319	89428	665784	83122	89406	680242	85308	89422	B71-6003	85029	
16725-01	83221		665785	83137		680253	85314	89425	B71-6004	85084	89460
19495-01	83126	89440	665788	85000	89436	680261	85062	89408	B71-6005	85084	89460
2018987C1PLUS	85003	89411	665828	85067	89451	680279	83209	89414	B71-6006	85084	89460
3166657	85700		665844	85069	89455	680280	85906	89407	B71-6007	85062	89408
471700004423	85109		665858	85070	89459	680281	85003	89411	B71-6008	83312	89409
47902-13PLUS	83122	89406	665903	85900		680283	83353		B71-6010	85023	89415
47902-19	83123	89405	665906	85902		680303	85007	89412	B71-6011	85062	89408
47902-24	83137		665918	85900		680425	85320	89429	B71-6012	85119	
60657-003	85072		665926	85047	89435	680435	85033	89427	B71-6013	85012	89413
60665-011	85967		665927	85901		680473	85319	89428	B71-6015	85012	89413
60665-013	85965		665928	85062	89408	680475	85314	89425	B71-6016	85012	89413
60665-015	85966		665930	85001	89410	680476	85310	89423	B71-6017	85910	
60670-005	83137		665931	83312	89409	680486	85310	89423	B71-6018	85012	89413
60670-005PLUS	83137		665932	85012	89413	680586	85311	89424	B71-6019	85989	
60670-008	83123	89405	665944	85900		70701	85900		B71-6020	85989	
60670-008PLUS	83123	89405	665945	85902		70701PLUS	85900		C71-1002	85067	89451
60680-004	83143		665950	85902		8086053PLUS	85047	89435	C71-1002PLUS	85067	89451
60680-005	83142		671052	85070	89459	90044025PLUS	83209	89414	C71-1011	85069	89455
665092	83312	89409	671654	85936	89456	90044089	83124	89407	C71-1011PLUS	85069	89455
665118	83312	89409	671656	85985		90044089PLUS	83124	89407	C71-1013	85985	
665174	85060		671699	85937		90045068	89441		C71-1014	85936	89456

Important Note: Competitive Interchanges are to be used for stocking purposes only. Where multiple crosses are identified, please reference the applications section of this catalog. / **Remarque importante:** Les interchanges concurrentiels ne s'utilisent qu'aux fins de stocks. Dans le cas de références multiples, consulter la section des applications du catalogue. / **Nota importante:** Dans le cas de références multiples, consulter la section des applications du catalogue. / **Nota importante:** Se pueden usar intercambios competitivos para propósitos de almacenamiento solamente. Cuando se identifican intercambios múltiples, consulte la sección de aplicaciones de este catálogo.

COMPETITIVE & O.E.M. INTERCHANGE LIST

Lista de Intercambios contra Competidores y Equipo Original.

Liste d'interchange de produits compétitifs & d'équipement original (OEM)

KENWORTH... cont'd

O.E.M #	Gabriel	Upgrade	O.E.M #	Gabriel	Upgrade	O.E.M #	Gabriel	Upgrade	O.E.M #	Gabriel	Upgrade
C71-1015	85937		K374-11	85001	89410	K374-28PLUS	85314	89425	K374-5	83312	89409
C71-1015 PLUS	85937		K374-13	83353		K374-29	85310	89423	K374-7	85310	89423
C71-1015A	85937		K374-13-1	83353		K374-29PLUS	85310	89423	K374-9	85310	89423
C71-1016	85067	89451	K374-14	83312	89409	K374-3	83312	89409	K374-C31	83312	89409
C71-1017	85069	89455	K374-15	83353		K374-3-1	83312	89409	K374-C7	85310	89423
C71-6003	85988		K374-16	85001	89410	K374-32	85310	89423	R71-6006	83063	
C71-6004	85343		K374-26	85001	89410	K374-33	83312	89409	R71-6007	83008	
C71-6005	85069	89455	K374-26PLUS	85001	89410	K374-33PLUS	83312	89409	R71-6008	83035	
C71-6015	85067	89451	K374-27	85001	89410	K374-36		89432	S-20126	85323	89436
K374-10	83362		K374-28	85314	89425	K374-4	85314	89425	TK19679	83126	89440

KENWORTH CAB SHOCKS

O.E.M #	Gabriel	Upgrade	O.E.M #	Gabriel	Upgrade	O.E.M #	Gabriel	Upgrade	O.E.M #	Gabriel	Upgrade
1201-0012	83023		1202-0054	83021		1202K064	83024		R71-6000	83067	
1201-1043	83025		1202-1043	83025		1202K065	83002		R71-6005	83042	
1201-1044	83025		1202-1046	83049		1202K164	83031		R71-6010	83067	
1201-1046	83049		1202-1064	83024		1202K264	83031		T71-1000	83031	
1202-0012	83023		1202-1065	83002		1202K286	83056		T71-1001	83031	
1202-0022	83046		1202-1164	83031		96027-10545	83011		T71-1002	83002	
1202-0032	83016		1202-1264	83031		PP1058870	83059		T71-1003	83056	
1202-0042	83025		1202-1286	83056		PP2582870	83012				
1202-0043	83032		1202-K065	83002		R71-1004	83049				
1202-0044	83025		1202K046	83049		R71-1005	83024				

KIMBLE MIXER CO

O.E.M #	Gabriel	Upgrade	O.E.M #	Gabriel	Upgrade	O.E.M #	Gabriel	Upgrade	O.E.M #	Gabriel	Upgrade
OE10455	646155										

KING OF THE ROAD

O.E.M #	Gabriel	Upgrade	O.E.M #	Gabriel	Upgrade	O.E.M #	Gabriel	Upgrade	O.E.M #	Gabriel	Upgrade
141700131809	85029		16-16736-000	85029		16-16873-000	85029		16-18103-000	85900	
141700131810	83160		16-16737-000	83160		16-16874-000	83160		481700000493	85900	

KONI

Koni	Gabriel	Upgrade	Koni	Gabriel	Upgrade	Koni	Gabriel	Upgrade	Koni	Gabriel	Upgrade
090-2209-SP2	85001	89410	82-1952	G63347		88-1499	85001	89410	8805-1003	85126	
30-1348	G63424		82-1954	G63355		88-1509	85027	89418	8805-1022	85724	89443
30-1350	G63511		82-1955	G63349		88-1510	85708		90-1400	83104	
30-1351	G63490		82-1969	G63500		88-1517	85040		90-1409-SP1	85722	
30-1365	G63611		82-1970	G63350		88-1518	85040		90-1466	85707	
30-1366	G63610		82-2158	G63357		88-1520	85040		90-1577-SP1	85310	89423
30-1381	G63426		82-2246	G63299		88-1525	85040		90-1608	83104	
30-1421	G63547		82-2345	G63413		88-1532	85708		90-1811	85301	
30-1422	G63548		82-2372	G63609		88-1540	85051		90-1813-SP1	85712	
30-1456	G63782		82-2384	G63488		88-1541	85045		90-1813-SP3	85968	
30-1457	G63781		8240-1029	G63386		88-1558	85013	89414	90-1862	85708	
30-1501	G63608		8240-1054	G63375		88-1559-SP1	85036	89405	90-1867	85053	89442
30-1502	G63679		8240-1055	G63454		88-1560	85062	89408	90-1868	85307	
30-1565	G63707		8240-1148	G63720		88-1561	85012	89413	90-1868-SP1	85307	
30-1566	G63708		84-1168	83130		88-1562	85003	89411	90-1896	85302	89420
30-1606	G63423		88-1385	83105		88-1616	85014		90-1897	85303	89422
30-1607	G63422		88-1417	83312	89409	88-1639	83130		90-1898	83215	
30-1614	G63678		88-1419	83136		88-1641	85029		90-1907-SP1	85300	89419
30-1624	G63424		88-1422	85030	89440	88-1642	83124	89407	90-1908-SP1	85723	
30-1627	G63690		88-1457-SP1	83209	89414	88-1644	85000	89436	90-1910	85704	
30-1630	G63425		88-1458-SP1	83122	89406	88-1646	83613		90-1912	85318	
30-1630	G63722		88-1458-SP2	83122	89406	88-1647	83317		90-1922	85900	
80-2516	G63421		88-1468	83209	89414	88-5162	83209	89414			
80-2517	G63422		88-1476	83353		88-5163	83122	89406			
80-2633	G63423		88-1489	85036	89405	8805-1001	85125				
80-2634	G63422		88-1490	83124	89407	8805-1002	85124				

Important Note: Competitive Interchanges are to be used for stocking purposes only. Where multiple crosses are identified, please reference the applications section of this catalog. / **Remarque importante:** Les interchanges concurrentiels ne s'utilisent qu'aux fins de stocks. Dans le cas de références multiples, consulter la section des applications du catalogue. / **Nota importante:** Dans le cas de références multiples, consulter la section des applications du catalogue. / **Nota importante:** Se pueden usar intercambios competitivos para propósitos de almacenamiento solamente. Cuando se identifican intercambios múltiples, consulte la sección de aplicaciones de este catálogo.

COMPETITIVE & O.E.M. INTERCHANGE LIST
Lista de Intercambios contra Competidores y Equipo Original.
Liste d'interchange de produits compétitifs & d'équipement original (OEM)

KONI... cont'd

Koni	Gabriel	Upgrade	Koni	Gabriel	Upgrade	Koni	Gabriel	Upgrade	Koni	Gabriel	Upgrade
90-1943	85307		90-2253-SP2	85718		90-2416 SP1	86202		90-2586	85728	
90-1951-SP1	85734		90-2254	85720		90-2433	85710		90-2587	85729	
90-1951-SP5	85712		90-2255	85719		90-2434	85702		90-2588	85339	
90-1965	85304		90-2256	85718		90-2477	85900		90-2589	85727	
90-1968	85720		90-2257	85716		90-2478	85902		90-2610-SP1	87017	
90-1974	85311	89424	90-2325	85340		90-2497SP1	85712		90-2627	89461	
90-2059	85722		90-2326	85970		90-2529	85707		90-5055-SP2	85318	
90-2060	85722		90-2327	85341		90-2530	85707		90-5180	85300	89419
90-2102-SP1	85708		90-2368	86203		90-2563	85006		9020-1042	85708	
90-2148	85304		90-2368 SP1	86203		90-2572	85329		90F-1235	85700	
90-2164-SP1	85723		90-2368 SP2	86203		90-2573	85329		91-2368	86203	
90-2209	85308	89422	90-2404	86203		90-2574	85330		91-2400	86203	
90-2251	85717		90-2407	85709		90-2575	85700		91-2527	86202	
90-2252	85714		90-2416	86202		90-2576	85700		92-1227	85722	

KWK-LOC (JIFFLOX)

O.E.M #	Gabriel	Upgrade	O.E.M #	Gabriel	Upgrade	O.E.M #	Gabriel	Upgrade	O.E.M #	Gabriel	Upgrade
CP-5222	85315										

KYB

Kyb	Gabriel	Upgrade	Kyb	Gabriel	Upgrade	Kyb	Gabriel	Upgrade	Kyb	Gabriel	Upgrade
340043	G63909		344040	G63421		344095	G63499		344387	G63617	
341302	G63678		344041	G63422		344096	G63460		344397	G63772	
341312	G63865		344042	G63423		344098	G63612		344398	G63958	
341339	G63918		344043	G63813		344202	G63479		344399	G63848	
341343	G63893		344044	G63907		344263	G63488		344401	G63970	
341374	G63884		344045	G63492		344264	G63387		344402	G63817	
341613	85062	89408	344046	G63491		344265	G63489		344404	G63844	
341614	85001	89410	344047	G63950		344266	G63818		344410	G63885	
341615	83215		344049	G63414		344267	G63455		344419	G63888	
341617	85005	89430	344050	G63773		344268	G63614		344426	G63299	
341618	85918	89449	344051	G63420		344269	G63679		344427	G63904	
341619	83136		344054	G63444		344272	G63386		344428	G63494	
341620	85033	89427	344055	G63484		344273	G63638		344430	G63611	
341621	85311	89424	344066	G63359		344291	G63873		344431	G63620	
341622	85023	89415	344067	G63347		344299	G63710		344435	G63721	
341623	85003	89411	344068	G63355		344338	G63776		344438	G63869	
341624	85036	89405	344069	G63500		344341	G63847		344464	G63882	
341625	85000	89436	344072	G63349		344342	G63829		344466	G63879	
341626	85000	89436	344074	G63811		344353	G63877		344481	G63894	
341627	85006		344075	G63413		344356	G63862		344496	G64012	
341628	85724	89443	344076	G63410		344359	G63720		345005	G63694	
341629	85938		344077	G63406		344364	G63673		345022	G63832	
341630	85052		344078	G63683		344365	G63662		345023	G63828	
341631	646155		344079	G63775		344366	G63366		345024	G63864	
341632	83124	89407	344080	G63426		344367	G63714		345030	83304	
341633	83215		344081	G63375		344368	G63716		345030	G63394	
343030	G63949		344082	G63454		344369	G63624		345042	G63883	
343127	G63900		344083	G63457		344370	G63622		345043	G63878	
343160	G63914		344084	G63490		344371	G63623		345055	G63872	
343209	G63903		344085	G63306		344372	G63661		345601	83613	
343210	G63799		344086	G63353		344373	G63675		345602	85052	
343272	G63860		344088	G63424		344374	G63778		345604	85051	
343353	G63880		344089	G63425		344375	G63715		345605	85012	89413
343379	G63845		344090	G63492		344377	G63717		345606	83136	
343388	G63712		344091	G63511		344380	G63783				
343395	G63842		344092	G63490		344381	G63803				
343395	G64014		344093	G63905		344382	G63887				
343403	G63660		344094	G63915		344385	G63866				

Important Note: Competitive Interchanges are to be used for stocking purposes only. Where multiple crosses are identified, please reference the applications section of this catalog. / **Remarque importante:** Les interchanges concurrentiels ne s'utilisent qu'aux fins de stocks. Dans le cas de références multiples, consulter la section des applications du catalogue. / **Nota importante:** Dans le cas de références multiples, consulter la section des applications du catalogue. / **Nota importante:** Se pueden usar intercambios competitivos para propósitos de almacenamiento solamente. Cuando se identifican intercambios múltiples, consulte la sección de aplicaciones de este catálogo.

COMPETITIVE & O.E.M. INTERCHANGE LIST
Lista de Intercambios contra Competidores y Equipo Original.
Liste d'interchange de produits compétitifs & d'équipement original (OEM)

KYB... cont'd

Kyb	Gabriel	Upgrade	Kyb	Gabriel	Upgrade	Kyb	Gabriel	Upgrade	Kyb	Gabriel	Upgrade
345607	83130		KG4160	G64016		KG54333	G63810		KG5495	G63929	
345608	85060		KG4613A	G63909		KG54335	G63815		KG5496	G63624	
345609	G63616		KG4616	G63798		KG5438	G63492		KG5497	G63622	
345611	83120		KG5194	G64000		KG5440	G63350		KG5498	G63623	
345613	85005	89430	KG5196	G64013		KG5442	G63626		KG5499	G63621	
345614	83309	89446	KG5198A	G63606		KG5444	G63904		KG5534	G63610	
345615	83314		KG5401	G63299		KG5446	G63909		KG5538	G63484	
345616	83125		KG5406	G63386		KG5447	G63491		KG5555	G63914	
345617	83203	89436	KG5417	G63371		KG5455	G63456		KG6001A	83304	
345618	83126	89430	KG5420	G63366		KG5456	G63416		KG6002A	85030	89440
345620	83456	89447	KG5421	G63387		KG5462	G63494		KG6003	83309	89416
345621	85003	89411	KG5422	G63183		KG5466	G63492		KG6004	85320	89429
349004	G63886		KG5424	G63187		KG5474	G63479		KG6005	83216	
349009	G63897		KG5426	G63396		KG5475	G63432		KG6006	85012	89413
349009	G63919		KG5429	G63398		KG5476	G63611		KG6007	85007	89412
349010	G64006		KG54300	G63615		KG5477	G63906		KG6008A	83122	89406
349119	89439		KG54301	G63616		KG5478	G63489		KG6009A	83303	
441600	85310	89423	KG54302	G63782		KG5479	G63488		KG6010	83308	89435
441601	85710		KG54303	G63781		KG5480	G63609		KG6198	G63616	
441602	85724	89443	KG54304	G63707		KG5482	G63675		KG6199	85012	89413
444058	83404		KG54305	G63640		KG5484	G63635		KG6201	83456	89447
444328	85055		KG54307	G63812		KG5485	G63639		KG6403	G63605	
444329	83509		KG54308	G63708		KG5487	G63525		KG6406	G63183	
553360	G63937		KG5431	G63511		KG5488	G63403		KG6412	G63625	
553361	G63689		KG54317	G63726		KG5489	G63614		KG6415	85013	89414
554347	G63886		KG54330	G63809		KG5491	G63604		KG6416	83123	89405
KG4159	G63892		KG54331	G63837		KG5494	G63620				

LEYLAND TRUCK

O.E.M #	Gabriel	Upgrade	O.E.M #	Gabriel	Upgrade	O.E.M #	Gabriel	Upgrade	O.E.M #	Gabriel	Upgrade
1456033	85311	89424									

LINK MANUFACTURING CAB SHOCKS

O.E.M #	Gabriel	Upgrade	O.E.M #	Gabriel	Upgrade	O.E.M #	Gabriel	Upgrade	O.E.M #	Gabriel	Upgrade
1201-0012	83023		1201-9011	83053		1202-1046	83049		654799	83025	
1201-0154	83051		1201-9013	83062		1202-1064	83024		654811	83024	
1201-0254	83051		1201-9014	83062		1202-1065	83002		654833	83021	
1201-1043	83025		1201-9018	83062		1202-1164	83031		654847	83002	
1201-1044	83025		1201-9021	83062		1202-1212	83013		654849	83031	
1201-1046	83049		1202-0012	83023		1202-1213	83005		654867	83025	
1201-1049	83025		1202-0022	83046		1202-1286	83056		LG40450	83016	
1201-1212	83013		1202-0032	83016		1202K065	83002		LG40470	83016	
1201-1213	83005		1202-0042	83025		1202K164	83031		R71-1004	83049	
1201-9001	83052		1202-0043	83032		1202K264	83031		R71-1005	83024	
1201-9002	83052		1202-0044	83025		1202K286	83056		T71-1000	83031	
1201-9003	83052		1202-0052	83021		1202P055	83061		T71-1001	83031	
1201-9007	83054		1202-0054	83021		632120	83046		T71-1002	83002	
1201-9008	83054		1202-1042	83025		632129	83023				
1201-9009	83054		1202-1043	83025		635705	83016				
1201-9010	83053		1202-1044	83025		654669	83021				

LINK MANUFACTURING LTD.

O.E.M #	Gabriel	Upgrade	O.E.M #	Gabriel	Upgrade	O.E.M #	Gabriel	Upgrade	O.E.M #	Gabriel	Upgrade
1210-0005	85734		1210-0528	85904		671093	85904				

LINK/HIGH-STEER

O.E.M #	Gabriel	Upgrade	O.E.M #	Gabriel	Upgrade	O.E.M #	Gabriel	Upgrade	O.E.M #	Gabriel	Upgrade
1210-0001	646155		1210-0007	665937		1210-0010	646155		632155	646177	
1210-0002	632147		1210-0009	665937		1210-0012	646155		646168	646155	

Important Note: Competitive Interchanges are to be used for stocking purposes only. Where multiple crosses are identified, please reference the applications section of this catalog. / **Remarque importante:** Les interchanges concurrentiels ne s'utilisent qu'aux fins de stocks. Dans le cas de références multiples, consulter la section des applications du catalogue. / **Nota importante:** Dans le cas de références multiples, consulter la section des applications du catalogue. / **Nota importante:** Se pueden usar intercambios competitivos para propósitos de almacenamiento solamente. Cuando se identifican intercambios múltiples, consulte la sección de aplicaciones de este catálogo.

COMPETITIVE & O.E.M. INTERCHANGE LIST

Lista de Intercambios contra Competidores y Equipo Original.

Liste d'interchange de produits compétitifs & d'équipement original (OEM)

LODAL, INC.

O.E.M #	Gabriel	Upgrade	O.E.M #	Gabriel	Upgrade	O.E.M #	Gabriel	Upgrade	O.E.M #	Gabriel	Upgrade
9960257	83122	89406									

LONDON MIXER

O.E.M #	Gabriel	Upgrade	O.E.M #	Gabriel	Upgrade	O.E.M #	Gabriel	Upgrade	O.E.M #	Gabriel	Upgrade
MB-37737-30	646155										

M.A.N. BUS

O.E.M #	Gabriel	Upgrade	O.E.M #	Gabriel	Upgrade	O.E.M #	Gabriel	Upgrade	O.E.M #	Gabriel	Upgrade
134	85709		81-43701-6538	85708		81-43701-6572	85708		9020M-1042	85709	
25-1700-106-654	85708		81-43701-6539	85708		81-43701-6573	85722				
81-43701-6537	85709		81-43701-6543	85708		81-43701-6609	85709				

MACK

O.E.M #	Gabriel	Upgrade	O.E.M #	Gabriel	Upgrade	O.E.M #	Gabriel	Upgrade	O.E.M #	Gabriel	Upgrade
1252607B000	85702		14QK-288P2	83217		14QK-413M6	83111		25624341	83110	
141700000373	85061	89450	14QK-29001P2	85303	89422	14QK-413M7	83111		25624351	85909	
141700000380	85061	89450	14QK-29301P1	83207	89407	14QK-414M	85906	89407	25624365	83217	
141700005839	85098		14QK-29301P2	83207	89407	14QK-414M2	85909		25625091	83215	
14QK-1200P4	83207	89407	14QK-29302	83207	89407	14QK-415M	83112		25625151	85036	89405
14QK-140	85304		14QK-29302P1	83207	89407	14QK-415M7	83112		25625187	83209	89414
14QK-140P1	83225		14QK-3100	85739		14QK-421M	85014		25625223	83111	
14QK-142	85305		14QK-3101M	85066	89448	14QK-422M	85933	89454	25625234	83125	
14QK-142AP1	83215		14QK-3107M	85061	89450	14QK-423M	85978		25625254	83125	
14QK-142P1	83215		14QK-3108	85080		14QK-424M	83147		25625743	85005	89430
14QK-143	83207	89407	14QK-3108M	85080		14QK-427M	85080		25626048	85080	
14QK-145	85307		14QK-3114M	85061	89450	14QK-428	85080		25626149	85080	
14QK-20001P2	85308	89422	14QK-3115M	85972		14QK-428M	85080		25632145	85001	89410
14QK-2100	83221		14QK-3116M	83101		14QK-431M	85061	89450	25632147	85305	
14QK-2100D-P4	83207	89407	14QK-366	85036	89405	14QK-434M	85014		25632561	83209	89414
14QK-2100P1	83221		14QK-366P1	85036	89405	14QK-493M	83101		25633154	85906	89407
14QK-2100P2	83209	89414	14QK-366P2	85036	89405	20469001	85933	89454	4103-5000447861	83105	
14QK-2100P3	83207	89407	14QK-366P3	85036	89405	20469002	85933	89454	4103-5000546892	83105	
14QK-2100P4	83207	89407	14QK-366P4	83209	89414	20485632	85933	89454	446-51-211	85739	
14QK-2100P5	83221		14QK-372M	83221		20485633	85933	89454	471700000431	85066	89448
14QK-2100P6	85036	89405	14QK-372M2	83209	89414	20513881	85061	89450	471700000445	85080	
14QK-2100P7	83221		14QK-372M3	83122	89406	20570098	83147		471700000451	85080	
14QK-2100P8	83242		14QK-373	83215		20625775	85014		471700002626	85061	89450
14QK-2102	85304		14QK-375M	83123	89405	20782199	85072		471700002861	85014	
14QK-2105	83209	89414	14QK-377M	83215		20863239	85080		471700006039	85088	
14QK-2107	83215		14QK-378	83215		20897198	85061	89450	471700009646	85088	
14QK-2107P1	83215		14QK-378M	83215		20973993	85061	89450	471700009647	85088	
14QK-2107P2	83215		14QK-390	83105		20998401	85014		471700131921	85933	89454
14QK-2107P3	83215		14QK-392AM	85005	89430	21002497	85972		47902-25	83125	
14QK-2108	83203	89436	14QK-392AM2	83123	89405	21010744	83101		47902-9	83123	89405
14QK-2108P1	83203	89436	14QK-392AM3	85005	89430	21155033	83101		4940654	83216	
14QK-2110	85305		14QK-392BM	85005	89430	21436096	85098		5533699	85302	89420
14QK-2110P1	85305		14QK-392BM2	85321		21462382	85088		5554184	85302	89420
14QK-2113	85001	89410	14QK-392BM3	85005	89430	21462384	85088		57241-004	83110	
14QK-2113P3	85001	89410	14QK-392M	85005	89430	21687170	85120		57241-006	83111	
14QK-2113P4	85007	89412	14QK-393AM	83123	89405	22202559	85088		5966-90044025	83209	89414
14QK-2113P5	85001	89410	14QK-393M	85010		22202560	85088		60657-007	85072	
14QK-2113P6	85007	89412	14QK-396	85005	89430	22314111	85036	89405	60670-006	83147	
14QK-2115	85305		14QK-396M	85005	89430	25621571	83215		60675-001	85978	
14QK-2133M	85001	89410	14QK-410M	83125		25621955	85001	89410	60675-13	85036	89405
14QK-2133M2	85001	89410	14QK-410M2	83137		25622221	83111		64838-002	85933	89454
14QK-2136M	85061	89450	14QK-410M3	83125		25622345	83242		650102	85001	89410
14QK-282P1	83216		14QK-413M	83111		25622466	85001	89410	650107	85316	89426
14QK-282P3	83216		14QK-413M4	83110		25623321	83215		650107MT	85316	89426
14QK-288-P1	85007	89412	14QK-413M5	83138		25624241	83112		650400MT	85033	89427

Important Note: Competitive Interchanges are to be used for stocking purposes only. Where multiple crosses are identified, please reference the applications section of this catalog. / **Remarque importante:** Les interchanges concurrentiels ne s'utilisent qu'aux fins de stocks. Dans le cas de références multiples, consulter la section des applications du catalogue. / **Nota importante:** Dans le cas de références multiples, consulter la section des applications du catalogue. / **Nota importante:** Se pueden usar intercambios competitivos para propósitos de almacenamiento solamente. Cuando se identifican intercambios múltiples, consulte la sección de aplicaciones de este catálogo.

COMPETITIVE & O.E.M. INTERCHANGE LIST
Lista de Intercambios contra Competidores y Equipo Original.
Liste d'interchange de produits compétitifs & d'équipement original (OEM)

MACK... cont'd

O.E.M #	Gabriel	Upgrade	O.E.M #	Gabriel	Upgrade	O.E.M #	Gabriel	Upgrade	O.E.M #	Gabriel	Upgrade
650402	85311	89424	650405MT	85023	89415	651103	85036	89405	SDA471700000431	85066	89448
650402MT	85311	89424	650406	85024	89416	651151	83209	89414	SDA471700002861	85014	
650404	85310	89423	650408	85319	89428	70042	85302	89420	V10234121	83105	
650404MT	85310	89423	650408MT	85319	89428	8083872	85978		V10242320	83105	
650405	85023	89415	651012	83221		SDA141700000380	85061	89450			

MACK CAB SHOCKS

O.E.M #	Gabriel	Upgrade	O.E.M #	Gabriel	Upgrade	O.E.M #	Gabriel	Upgrade	O.E.M #	Gabriel	Upgrade
1201-0012	83023		14QK-376	83003		14QK-399M2	83045		21154397	83058	
1202-0012	83023		14QK-382	83018		14QK-399M3	83045		21345868	83066	
1202-0022	83046		14QK-382-P2	83018		14QK-411	83007		21345869	83066	
1202-0032	83016		14QK-391AM	83041		14QK-411AM	83007		21490486	83066	
14QK-2111	83019		14QK-391AM2	83041		14QK-411M	83007		25622612	83041	
14QK-2111-P2	83019		14QK-391BM	83041		14QK-432M	83050		25622613	83041	
14QK-2111-P4	83019		14QK-391BM2	83041		14QK-439M	83050		25624837	83041	
14QK-29303-P2	83014		14QK-391M	83041		14QK-440M	83058		25625635	83045	
14QK-303M	83050		14QK-391M2	83041		20873442	83050		25625636	83045	
14QK-3103M	83050		14QK-397AM	TBR-83905		20874147	83050		25625637	83045	
14QK-374	83003		14QK-399M	83045		21154393	83050		25631922	83007	

MAECO

O.E.M #	Gabriel	Upgrade	O.E.M #	Gabriel	Upgrade	O.E.M #	Gabriel	Upgrade	O.E.M #	Gabriel	Upgrade
1085	83214		16777	85006		70088	85307		70644	85334	
12608	83125		16778	83203		70123	85716		70646	85313	
12788	83216		16779	83126	89440	70127	85006	89401	70647	85701	
12866	83207	89407	16780	83123	89405	70128	85006	89401	70648	89414	
16385	83215		16781	85006		70162	85716		70650	89440	
1668722	85030	89440	16787	85030	89440	70163	85302	89420	70651	85013	89414
16720	83107		16949	83120		70164	85716		70652	85030	89440
16767	85013		16950	83118		70300	85320	89429	70663	85013	89414
16768	83217		6025	83122	89406	70312	85001	89410	70691	85007	
16769	83221		6026	83204		70315	85063		70720	85934	
16770	83209		70018	85303	89422	70317		89432	70721	83125	
16771	83126	89430	70021	85303	89422	70331	85314	89425	74039	85303	89422
16772	83122	89406	70029	85308	89422	70332	83314		OE10881	85711	
16773	85005		70034	85302	89420	70334	85316	89426	OE10882	85740	
16774	83215		70039	85303	89422	70397	85006		OE10883	85339	
16775	83207	89407	70041	85305		70402	85305		OE12425	83214	
16776	83122		70042	85302	89420	70642	85300		SC-2920	83176	

MANDALAY COACH

O.E.M #	Gabriel	Upgrade	O.E.M #	Gabriel	Upgrade	O.E.M #	Gabriel	Upgrade	O.E.M #	Gabriel	Upgrade
141700131809	85029		16-16736-000	85029		16-16873-000	85029		16-18103-000	85900	
141700131810	83160		16-16737-000	83160		16-16874-000	83160		481700000493	85900	

MARMON

O.E.M #	Gabriel	Upgrade	O.E.M #	Gabriel	Upgrade	O.E.M #	Gabriel	Upgrade	O.E.M #	Gabriel	Upgrade
1-7001	83216		51-139-28	85003	89411	576451	83122	89406			
37-1-1	83122	89406	51-163-7	83123	89405	665147	83216				

MARMON CAB SHOCKS

O.E.M #	Gabriel	Upgrade	O.E.M #	Gabriel	Upgrade	O.E.M #	Gabriel	Upgrade	O.E.M #	Gabriel	Upgrade
1202-0022	83046		1202-0054	83021							

MATSON SCHOOL BUS

O.E.M #	Gabriel	Upgrade	O.E.M #	Gabriel	Upgrade	O.E.M #	Gabriel	Upgrade	O.E.M #	Gabriel	Upgrade
5392387	85303	89422									

MC NEILUS TRUCK & MAN.

O.E.M #	Gabriel	Upgrade	O.E.M #	Gabriel	Upgrade	O.E.M #	Gabriel	Upgrade	O.E.M #	Gabriel	Upgrade
1139039 MTM	85334		1139069 MTM	83209	89414	1323106 MTM	85305		1340976 MTM	85919	
1139046 MTM	83112		1170719	632147		1333575 MTM	85072		1340979 MTM	83143	
1139059 MTM	83207	89407	12405FX1 MTM	85303	89422	1340975 MTM	83142		1360386 MTM	85323	89436

Important Note: Competitive Interchanges are to be used for stocking purposes only. Where multiple crosses are identified, please reference the applications section of this catalog. / **Remarque importante:** Les interchanges concurrentiels ne s'utilisent qu'aux fins de stocks. Dans le cas de références multiples, consulter la section des applications du catalogue. / **Nota importante:** Dans le cas de références multiples, consulter la section des applications du catalogue. / **Nota importante:** Se pueden usar intercambios competitivos para propósitos de almacenamiento solamente. Cuando se identifican intercambios múltiples, consulte la sección de aplicaciones de este catálogo.

COMPETITIVE & O.E.M. INTERCHANGE LIST
Lista de Intercambios contra Competidores y Equipo Original.
Liste d'interchange de produits compétitifs & d'équipement original (OEM)

MC NEILUS TRUCK & MAN.... cont'd

O.E.M #	Gabriel	Upgrade	O.E.M #	Gabriel	Upgrade	O.E.M #	Gabriel	Upgrade	O.E.M #	Gabriel	Upgrade
1367383 MTM	83147		1433009 MTM	85962		3HR916 MTM	83207	89407	6HB390 MTM	83137	
1396513 MTM	85959		1468783 MTM	85345		4HA569 MTM	85932	89453	6HD720 MTM	85909	
1398980 MTM	83127		1473224	646155		4KP398 MTM	85933	89454	6HS773 MTM	83122	89406
1404068 MTM	85087		1485576 MTM	85979		5HA994 MTM	85916		6KP857 MTM	85000	89436
1404068 MTM	85980		1491909 MTM	83128	89436	5HB645 MTM	83109		7HS237 MTM	83122	89406
1410046 MTM	85919		1KK552 MTM	85967		5KK247 MTM	85977		7HS534 MTM	85906	89407
1411765 MTM	83148		2034140 MTM	646155		600-115994B	632147		8KK524 MTM	83168	
1412744 MTM	85966		217330	85303		600-11599M	632147		9HB362 MTM	85976	
1429317 MTM	85919		2218640 MTM	83009		600-188206	646155		9KK464 MTM	85079	
1431085 MTM	85738		3215395 MTM	83112		64442AX MTM	83128				
1432386 MTM	85965		3HR582 MTM	85013	89414	6HA961 MTM	83123	89405			

MERITOR

O.E.M #	Gabriel	Upgrade	O.E.M #	Gabriel	Upgrade	O.E.M #	Gabriel	Upgrade	O.E.M #	Gabriel	Upgrade
14QK-3100	85739		446-51-211	85739		671507	87015		A-7805F-1020	86200	
202447	85919		671020	87015		671907	85919		A-7805L-1000	85919	
21224745	86203		671500	86201		680705	85737		A-7805L-1026	87015	
21224778	86202		671502	86202		700115	85712		A-7805P-1030	85737	
21227751	87015		671503	86203		7805-F-1020	86200		KIT11210	87015	
21228392	86201		671506	86200		A-3280-M-9711	85919				

MITSUBISHI-FUSO

O.E.M #	Gabriel	Upgrade	O.E.M #	Gabriel	Upgrade	O.E.M #	Gabriel	Upgrade	O.E.M #	Gabriel	Upgrade
MB161497	G63299		MC809390	83103		MC813511	G63398		MC826268	G63610	
MC114595	G63405		MC813135	83456	89447	MC814614	85009				

MOHAWK

O.E.M #	Gabriel	Upgrade	O.E.M #	Gabriel	Upgrade	O.E.M #	Gabriel	Upgrade	O.E.M #	Gabriel	Upgrade
01-0100-905	85303	89422	10234504	85717		6-367-7	85305		97-2201-00007	85703	
020273544	83203	89436	1235233	85736		680323	85700		97-2201-00011	85704	
050134508	85718		22012079	85701		680332	85701		97-9999-02320	85704	
10134504	85715		22012082	85702		680485	85733		MM-6886	83207	89407
10134506	85714		22012114	85700		695195	85707		MM-6957	83225	
10234503	85714		4968853	83216		695196	85707		MM-74029	85308	89422

MONACO

O.E.M #	Gabriel	Upgrade	O.E.M #	Gabriel	Upgrade	O.E.M #	Gabriel	Upgrade	O.E.M #	Gabriel	Upgrade
24-186537	85126		24-186629	85125		F4-BE5-A011-HO	85126		F4-BE5-B492-HO	85125	

MONROE

Monroe	Gabriel	Upgrade	Monroe	Gabriel	Upgrade	Monroe	Gabriel	Upgrade	Monroe	Gabriel	Upgrade
12872	83219		34518	G63809		34729	G63414		34782	G63674	
16385	83215		34519	G63837		34730	G63386		34787	G63615	
16721	83125		34523	G63969		34732	G63455		34788	G63616	
171322	G63679		34524	77968		34733	G63617		34791	G63692	
171341	G64014		34612	83017		34736	G63394		34793	61520	
31029	G63798		34617	83019		34741	G63489		34794	G63360	
32066	G63900		34655	G63714		34751	G63607		34796	G63929	
32207	G63949		34656	G63778		34755	G63812		34797	G63406	
32217	G63612		34657	G63716		34756	G63638		34798	G63609	
32273	G63782		34658	G63715		34759	G63624		34799	G63609	
32274	G63781		34675	G63783		34760	G63622		34802	83216	
32314	G63604		34676	G63662		34761	G63623		34803	G63306	
32341	G63675		34677	G63803		34762	G63638		34817	G63355	
32392	G63848		34684	G63622		34763	58638		34821	G63406	
33049	G63610		34685	G63808		34767	G63638		34822	G63371	
34504	G63817		34686	G63809		34768	83209	89414	34824	G63349	
34514	G63958		34687	G63810		34776	G63661		34828	G63510	
34515	G63675		34690	G63675		34777	G63662		34831	G63359	
34516	G63848		34721	83103		34778	G63673		34832	61526	
34517	G63837		34722	83400		34781	G63675		34839	G63671	

Important Note: Competitive Interchanges are to be used for stocking purposes only. Where multiple crosses are identified, please reference the applications section of this catalog. / **Remarque importante:** Les interchanges concurrentiels ne s'utilisent qu'aux fins de stocks. Dans le cas de références multiples, consulter la section des applications du catalogue. / **Nota importante:** Dans le cas de références multiples, consulter la section des applications du catalogue. / **Nota importante:** Se pueden usar intercambios competitivos para propósitos de almacenamiento solamente. Cuando se identifican intercambios múltiples, consulte la sección de aplicaciones de este catálogo.

COMPETITIVE & O.E.M. INTERCHANGE LIST
Lista de Intercambios contra Competidores y Equipo Original.
Liste d'interchange de produits compétitifs & d'équipement original (OEM)

MONROE... cont'd

Monroe	Gabriel	Upgrade	Monroe	Gabriel	Upgrade	Monroe	Gabriel	Upgrade	Monroe	Gabriel	Upgrade
34868	61650		37046	G63389		37128	G63929		550051	43140	
34895	83207	89407	37047	G63902		37129	G63421		551001	83125	
34899	G63500		37048	G63492		37130	G63609		551002	83122	89406
34900	G63386		37049	G63355		37131	G63714		553001	79900	
34901	G63387		37050	G63489		37132	G63778		553002	G56778	
34904	G63299		37051	G63490		37133	G63716		555004	G63299	
34905	G63405		37052	G63406		37134	G63715		555005	G63689	
34906	G63396		37053	G63386		37135	G63722		555006	G63173	
34907	G63511		37055	G63455		37144	G63717		555010	77623	
34909	G63187		37058	G63457		37149	G63783		555011	83119	
34910	61516		37060	G63621		37151	G63803		555012	G63183	
34911	G63350		37061	G63502		37153	G63772		555019	85069	89455
34912	83304		37062	G63818		37155	G63676		555026	83124	89407
34919	G63411		37063	G63375		37156	G63869		555027	83124	89407
34920	G63675		37064	G63454		37157	G63726		555028	83207	89407
34927	G63409		37065	G63426		37158	G63712		555029	83144	
34928	G63416		37066	G63915		37160	G63710		555031	83177	
34929	G63403		37067	G63460		37161	G63847		555032	83178	
34930	G63811		37068	G63905		37162	G63829		555033	G63386	
34944	61516		37069	G63499		37163	G63817		555034	G63387	
34954	G63484		37070	G63799		37164	G63675		555035	G63357	
34958	G63377		37071	G63914		37166	G63866		555036	77403	
34959	G63432		37072	G63903		37178	G63803		555037	G63359	
34960	G63366		37073	G63907		37191	G63506		555038	G63413	
34963	G63406		37074	G63620		37198	G63694		555039	G63359	
34964	G63456		37075	G63606		37199	G63860		555041	G63866	
34972	G63610		37076	G63639		37202	G64002		555043	83400	
34975	G63511		37077	G63909		37203	G63844		555045	G63394	
34983	G63489		37080	G63624		37204	G63845		557001	85013	89414
34985	61543		37082	G63626		37206	G63958		557002	85097	
37011	G63414		37085	G63896		37217	G63862		557004	G63866	
37012	G63603		37086	G63897		37218	G63877		557005	83136	
37013	G63525		37088	G63500		37231	G63720		557006	83136	
37014	G63524		37089	G63350		37238	G63815		557007	85099	
37015	G63614		37090	G63357		37240	G63865		557008	85029	
37016	G63635		37091	G63413		37241	G63842		557009	85007	89412
37017	G63639		37093	G63359		37242	G64014		557010	83144	
37021	G63422		37094	G63353		37243	G63610		557011	83160	
37022	G63495		37097	G63950		37244	G63864		557012	85029	
37024	G63610		37099	G63423		37246	G64003		557013	83127	
37026	G63424		37100	G63904		37249	G63434		557014	83126	89430
37027	G63425		37101	G63660		37803	G63306		557015	83209	89414
37028	G63904		37102	G63661		38072	83043		557017	85029	
37029	G63928		37103	G63662		39052	G63868		557018	83127	
37030	G63547		37104	G63673		40209	83161		557020	83123	89405
37031	G63404		37108	G63707		54487	85073		557021	85051	
37032	G63494		37109	G63708		54488	85074		557022	85051	
37033	G63548		37110	G63676		550010	G63375		557023	83144	
37035	G63607		37111	G63937		550011	69606		557026	83127	
37036	G63410		37112	G63689		550012	G63375		557027	83144	
37038	G63461		37113	G64005		550013	69724		557028	85010	
37040	G63347		37114	G64004		550016	G63424		557031	85010	
37041	G63349		37120	G63511		550017	G63425		557032	85126	
37042	G63906		37121	G63490		550018	69575		557033	85900	
37044	G63488		37122	G63678		550019	G63918		557038	85125	
37045	G63183		37123	G63690		550020	G63919		557039	85959	

Important Note: Competitive Interchanges are to be used for stocking purposes only. Where multiple crosses are identified, please reference the applications section of this catalog. / **Remarque importante:** Les interchanges concurrentiels ne s'utilisent qu'aux fins de stocks. Dans le cas de références multiples, consulter la section des applications du catalogue. / **Nota importante:** Dans le cas de références multiples, consulter la section des applications du catalogue. / **Nota importante:** Se pueden usar intercambios competitivos para propósitos de almacenamiento solamente. Cuando se identifican intercambios múltiples, consulte la sección de aplicaciones de este catálogo.

COMPETITIVE & O.E.M. INTERCHANGE LIST
Lista de Intercambios contra Competidores y Equipo Original.
Liste d'interchange de produits compétitifs & d'équipement original (OEM)

MONROE... cont'd

Monroe	Gabriel	Upgrade	Monroe	Gabriel	Upgrade	Monroe	Gabriel	Upgrade	Monroe	Gabriel	Upgrade
557040	85092		65172	83153		65451	85029		65508	83142	
5777	G63880		65173	85336		65452	85733		65509	85079	
65101	85062	89408	65174	58942		65453	85904		65510	85052	
65102	85001	89410	65175	85084	89460	65454	85030	89440	65511	85939	
65103	85320	89429	65176	85084	89460	65455	85716		65512	85938	
65104	85026	89417	65177	85012	89413	65456	85376		65513	85338	
65105	85026	89417	65178	85998		65457	85909		65514	85099	
65106	85091		65179	85995		65458	85908		65515	85097	
65107	85316	89426	65400	85033	89427	65459	85043		65516	85013	89414
65108	85030	89432	65401	85013	89414	65461	85059		65517	83165	
65109	85058	89431	65402	85311	89424	65462	85913		65518	85089	
65110	85005	89430	65404	85310	89423	65463	85040		65519	85060	
65111	85006		65405	85023	89415	65464	85968		65520	85121	
65112	89402		65406	85024	89416	65465	85939		65521	85014	
65113	85012	89413	65407	85736		65466	85047	89435	65522	85082	
65114	85036	89405	65408	85319	89428	65467	85054	89438	65523	85937	
65115	85027	89418	65409	85003	89411	65468	85069	89455	65524	85936	89456
65116	85329		65410	85300	89419	65469	85708		65525	87015	
65118	85001	89410	65411	85036	89405	65470	85708		65526	85956	
65119	85029		65412	83122	89406	65471	85302	89420	65527	85955	
65120	85010		65413	83136		65472	85330		65528	85069	89455
65121	85971		65414	85324		65473	85329		65529	85984	
65122	85063		65415	85046	89434	65474	85712		65530	85932	89453
65123	85054	89438	65416	85000	89436	65475	85065		65531	85334	
65124	85053	89442	65417	85322		65476	85736		65532	85967	
65128	85031		65418	85906	89407	65477	85702		65533	85120	
65129	85701		65419	85000	89436	65478	85058	89431	65534	85343	
65130	85061	89450	65420	85013	89414	65479	83122	89406	65535	85954	
65133	85935		65421	85916		65480	83111		65536	85965	
65139	85918	89449	65422	85912		65481	85036	89405	65537	85962	
65140	85918	89449	65423	85907		65482	85006		65538	85966	
65141	85091		65424	85905		65483	85978		65539	85961	
65142	83131		65425	85056	89441	65484	85976		65541	85119	
65143	83163		65426	85054	89438	65485	85972		65542	85102	
65144	85928		65427	85903		65486	85066	89448	6603	83103	
65145	85929		65428	85321		65487	85927		6604	83101	
65146	85925		65429	85030	89440	65488	85926		6605	83613	
65147	85924	89457	65430	85968		65489	85331		6606	83636	
65148	85918	89449	65431	85909		65490	85724	89443	6607	85052	
65150	85953		65432	85910		65491	85930		6608	83128	
65151	85953		65433	85910		65492	85931	89458	6609	83635	
65153	85921		65434	85012	89413	65493	85934		6610	85051	
65155	83175		65435	85901		65494	85061	89450	66101	83042	
65157	85954		65436	85900		65495	85067	89451	66102	83059	
65158	85954		65439	85716		65496	83138		66102	83063	
65159	85070	89459	65440	85711		65497	85933	89454	66103	83046	
65160	85080		65441	85704		65498	85964		66104	83021	
65161	83136		65442	85700		65499	85963		66105	83044	
65162	85959		65443	85706		65500	85738		66106	83016	
65163	85954		65444	85311	89424	65501	85323	89436	66107	83048	
65166	85090		65445	85731		65502	85938		66108	83028	
65167	G63969		65446	85730		65503	85919		66109	83048	
65168	77968		65447	85703		65504	85072		66111	83016	
65169	85342		65448	85700		65505	85006		66112	83017	
65170	85969		65449	85702		65506	83168		66113	83050	
65171	85964		65450	85701		65507	83143		66114	83045	

Important Note: Competitive Interchanges are to be used for stocking purposes only. Where multiple crosses are identified, please reference the applications section of this catalog. / **Remarque importante:** Les interchanges concurrentiels ne s'utilisent qu'aux fins de stocks. Dans le cas de références multiples, consulter la section des applications du catalogue. / **Nota importante:** Dans le cas de références multiples, consulter la section des applications du catalogue. / **Nota importante:** Se pueden usar intercambios competitivos para propósitos de almacenamiento solamente. Cuando se identifican intercambios múltiples, consulte la sección de aplicaciones de este catálogo.

COMPETITIVE & O.E.M. INTERCHANGE LIST
Lista de Intercambios contra Competidores y Equipo Original.
Liste d'interchange de produits compétitifs & d'équipement original (OEM)

MONROE... cont'd

Monroe	Gabriel	Upgrade	Monroe	Gabriel	Upgrade	Monroe	Gabriel	Upgrade	Monroe	Gabriel	Upgrade
66115	83045		66419	85931	89458	66633	83127		66720	85003	89411
66116	83018		66422	83163		66634	83203	89436	66801	83161	
66117	83019		66423	85001	89410	66636	83127		66811	83312	89409
66118	83001		66424	85310	89423	66637	83304		66813	83303	
66121	83047		66425	85920		66638	83123	89405	66828	83159	
66122	83038		66426	85924	89457	66639	G63610		66829	83103	
66123	83004		66427	89441		66642	G63866		66833	83126	89430
66124	83040		66428	85033	89427	66643	83007		66841	83216	
66125	83035		66429	85311	89424	66645	83008		66858	G63183	
66126	83051		66430	83309	89416	66646	83308	89435	66860	83308	89435
6613	83123	89405	66431	85066	89448	66647	83009		66861	83309	89446
66131	83062		66432	85319	89428	66648	83112		66863	83314	
66132	83001		66433	85918	89449	66649	83010		66864	83104	
6614	83125		66434	85069	89455	66650	83003		66868	83219	
66142	83039		66435	83219		66653	83515		66871	G63605	
66143	83007		66436	85067	89451	66654	83014		66878	83221	
66145	83008		66442	83150		66656	83110		66883	83314	
66147	83009		66443	83150		66657	83015		66884	83125	
66149	83022		66445	83135		66658	85009		66886	83124	89407
6615	83120		66447	83180		66659	83002		66891	83215	
66150	83003		66486	85066	89448	66660	85059		66893	83203	89436
66152	83012		66502	646155		66661	83123	89405	66894	83137	
66154	83014		66503	646155		66664	83215		66897	83126	89430
66157	83015		66504	632147		66665	83109		66898	83125	
66159	83031		66506	646155		66666	G63671		66902	83401	
66160	83052		66535	85062	89408	66668	83313	89439	66903	83400	
66161	83054		6658	85009		66669	83111		66912	83304	
66162	83025		66601	83114		66670	83200		66913	83303	
66169	83027		66602	83161		66671	83123	89405	66921	83318	
66178	83023		66603	83103		66672	83209	89414	66922	83301	
66179	83013		66604	83101		66677	83114		66923	83456	89447
66181	83025		66605	83613		66678	83023		66924	83317	
66182	83005		66606	83636		66679	83013		66956	83101	
66189	83041		66607	85052		66680	83317		66957	83225	
66193	83034		66608	83128		66681	83025		66966	83353	
66195	83033		66609	83635		66682	83005		66969	83126	89430
66196	83027		66610	83130		66683	83101		6701	83215	
66198	83158		66611	83016		66684	85007	89412	6707	83215	
66199	83048		66612	83017		66686	85014		6708	83100	
66200	83066		66613	83123	89405	66691	83118		6710	83209	89414
66203	83067		66614	83125		66692	83120		6712	85040	
66204	83024		66615	83120		66693	83034		6713	83105	
66205	83063		66616	83018		66695	83033		6714	83216	
66400	G63432		66617	83019		66697	83164		6715	85026	89417
66402	83157		66618	83159		66699	83113		6716	85042	
66403	83154		66620	83162		66701	83215		6717	G63616	
66405	83154		66623	83004		66707	83215		6718	85024	89416
66406	85920		66624	83141		66708	83100		6719	83242	
66407	83134		66625	83162		66710	83209	89414	6720	85003	89411
66408	83145		66626	85071		66712	83100		6721	83103	
66409	83146		66627	85045		66713	83105		6801	G63484	
66412	83156		66628	83136		66714	83216		6803	G63907	
66415	G63918		66629	83107		66715	85026	89417	6811	83312	89409
66416	85085		66630	83216		66716	85042		6817	G63355	
66417	G63919		66631	83140		66717	83515		6824	G63349	
66418	85918	89449	66632	83006		66719	83242		6828	83219	

Important Note: Competitive Interchanges are to be used for stocking purposes only. Where multiple crosses are identified, please reference the applications section of this catalog. / **Remarque importante:** Les interchanges concurrentiels ne s'utilisent qu'aux fins de stocks. Dans le cas de références multiples, consulter la section des applications du catalogue. / **Nota importante:** Dans le cas de références multiples, consulter la section des applications du catalogue. / **Nota importante:** Se pueden usar intercambios competitivos para propósitos de almacenamiento solamente. Cuando se identifican intercambios múltiples, consulte la sección de aplicaciones de este catálogo.

COMPETITIVE & O.E.M. INTERCHANGE LIST

Lista de Intercambios contra Competidores y Equipo Original.

Liste d'interchange de produits compétitifs & d'équipement original (OEM)

MONROE... cont'd

Monroe	Gabriel	Upgrade	Monroe	Gabriel	Upgrade	Monroe	Gabriel	Upgrade	Monroe	Gabriel	Upgrade
6829	83103		70332	83314		74416	85705	89447	74473	85716	
6831	G63359		70334	85316	89426	74417	85311	89424	74475	85746	
6833	83126	89430	70402	85305		74418	85709		74476	85745	
6839	G63357		70447	85940		74420	85003	89411	74477	83165	
6840	83217		70447	85949		74421	85708		74478	85089	
6841	83216		70448	85943		74422	85733		911030	G63479	
6860	83308	89435	70449	85942		74423	85712		911171	G63813	
6861	83309	89446	70454	85941		74424	85308	89422	911172	G63491	
6863	83314		70459	85948		74425	85724	89443	911183	G63832	
6864	83104		70459	85951		74426	85333		911184	G63828	
6868	G63360		70477	85949		74427	85308	89422	911222	G63970	
6878	83221		70720	85934		74429	85919		911228	G63882	
6886	83124	89407	74001	85307		74430	85340		911229	G63884	
6891	83215		74003	85314	89425	74431	85341		911230	G63879	
6893	83203	89436	74004	85315		74432	85970		911251	G63878	
6894	83209	89414	74006	85304		74433	85331		911252	G63883	
6895	83204		74012	85736		74434	85711		911253	G63875	
6897	83126	89430	74024	85308	89422	74435	87017		911255	G63894	
6898	83125		74025	85303	89422	74436	85334		911256	G63893	
6900	G63386		74028	85302	89420	74437	89461		911257	G63895	
6901	G63387		74029	85308	89422	74438	85734		911258	G63872	
6902	83401		74069	85301		74439	85728		911259	G64016	
6903	83400		74070	85701		74440	85729		911260	G63892	
6910	G63413		74073	85320	89429	74441	85339		911265	G64010	
6911	G63350		74074	85722		74442	85727		911266	G63886	
6912	83304		74075	85712		74443	85377		911267	G63887	
6913	83303		74076	85706		74444	85378		911268	G63888	
6916	83123	89405	74077	85324		74445	85381		911270	G63885	
6920	G63411		74078	85027	89418	74451	85711		911277	G63890	
6921	83318		74079	85336		74452	85740		911278	G64012	
6922	83301		74080	85332		74453	85339		911279	G63889	
6923	83456	89447	74081	85727		74454	85314	89425	911280	G64007	
6927	G63409		74400	85700		74457	695406		911508	G64000	
6945	G63421		74402	85711		74458	695406		911527	G64001	
6956	83101		74405	85300	89419	74461	87019		911528	G63965	
6957	83225		74406	85712		74462	85346		911533	G63959	
6960	G63366		74408	85702		74463	85347		911534	G64011	
6969	83126	89430	74409	85310	89423	74464	85318		911535	G64013	
6994	83122	89406	74410	85701		74465	85708		911536	G64008	
70039	85303	89422	74411	85703		74466	85318		911538	G63966	
70166	85301		74412	85704		74467	85723		911539	G63967	
70300	85320	89429	74413	85313		74470	89461		SC-2920	83176	
70312	85001	89410	74414	85723		74471	85736				
70331	85314	89425	74415	85318		74472	85303	89422			

MOR-RYDE SUSPENSION

O.E.M #	Gabriel	Upgrade	O.E.M #	Gabriel	Upgrade	O.E.M #	Gabriel	Upgrade	O.E.M #	Gabriel	Upgrade
U0109-006	G63866		U0109-007	G63183		U0109-014	83400		U0109-018	G63866	

MOTOR COACH INDUSTRIES

O.E.M #	Gabriel	Upgrade	O.E.M #	Gabriel	Upgrade	O.E.M #	Gabriel	Upgrade	O.E.M #	Gabriel	Upgrade
01-205219	85727		12-05-1138	85970		12-05-1166	85341		12-05-1199	85729	
12-05-1021	85340		12-05-1139	85341		12-05-1170	85340		12-05-1228	85711	
12-05-1022	85970		12-05-1142	85340		12-05-1176	85728		12-05-1242	85728	
12-05-1023	85341		12-05-1146	85340		12-05-1177	85729		12-05-1243	85729	
12-05-1101	85340		12-05-1147	85341		12-05-1178	85339				
12-05-1102	85970		12-05-1148	85970		12-05-1179	85727				
12-05-1103	85341		12-05-1150	85711		12-05-1188	85970				
12-05-1137	85340		12-05-1165	85711		12-05-1194	85339				

Important Note: Competitive Interchanges are to be used for stocking purposes only. Where multiple crosses are identified, please reference the applications section of this catalog. / **Remarque importante:** Les interchanges concurrentiels ne s'utilisent qu'aux fins de stocks. Dans le cas de références multiples, consulter la section des applications du catalogue. / **Nota importante:** Dans le cas de références multiples, consulter la section des applications du catalogue. / **Nota importante:** Se pueden usar intercambios competitivos para propósitos de almacenamiento solamente. Cuando se identifican intercambios múltiples, consulte la sección de aplicaciones de este catálogo.

COMPETITIVE & O.E.M. INTERCHANGE LIST

Lista de Intercambios contra Competidores y Equipo Original.

Liste d'interchange de produits compétitifs & d'équipement original (OEM)

MOTOR COACH INDUSTRIES... cont'd

O.E.M #	Gabriel	Upgrade	O.E.M #	Gabriel	Upgrade	O.E.M #	Gabriel	Upgrade	O.E.M #	Gabriel	Upgrade
12-05-1244	85727		12L-4-170	83158		3178154	85735		680681	85727	
12-05-1327	85728		12L-5-100	85727		3178157	85700		690029	85700	
12-05-1328	85729		12L-5-114	85727		4975515	85701		695117	85701	
12-05-1329	85727		12L-5-58	85728		5975515GS	85701		695125	85704	
12-05-6000	85711		12L-5-67	85728		5316984	85313		74410	85701	
12-05-6001	85740		12L-5-69	85700		63-0127GS	85303	89422	85729	85729	
12-05-6002	85339		12L-5-70	85700		6314933	85708		97-2201-00151	85700	
12-05-6033	85339		12L-5-71	85708		654789	83158		97-2210-00164	85708	
12-05-6053	85711		12L-5-72	85709		680231	85313		97-9999-02514	85700	
12-05-6054	85740		12L-5-88	85729		680232	85733		97-9999-02585	85723	
12-05-6055	85339		12L-5-89	85729		680322	85704		97-9999-02634	85733	
12-05-6068	85727		12L-5-96	85728		680323	85700		G1011822	85702	
12-5-1-G	85700		12L-5-97	85728		680332	85701		G1101590	85713	
12-5-1-GS	85700		12L-5-98	85339		680333	85708		G1101590GS	85713	
12B-5-1	85735		12L-5-99	85339		680350	85710		G1201338	85710	
12B-5-1-G	85700		12T-1-13	85303	89422	680369	85708		G1201339	85702	
12B-5-1-GS	85700		12TA-01-013	85303	89422	680374	85728		G5008069	85700	
12G-5-1	85700		1497835	85711		680441	85729		OE10086S	85702	
12J-5-10	85733		1498200	85740		680452	85339		OE10881	85711	
12J-5-10GS	85733		1498565	85339		680462	85728		OE10882	85740	
12J-5-11	85313		22012066	85707		680470	85713		OE10883	85339	
12J-5-2	85312		22012067	85700		680482	85727		T12-1208	85727	
12J-5-3	85313		22012079	85701		680485	85733		T14-1029	85701	
12J-5-4	85312		22024061	85704		680544	85711		T14-1045GS	85700	
12J-5-6	85313		22024673	85710		680546	85339		T14-1048	85302	89420
12J-5-7	85312		22045526	85702		680602	85339		T14-1080	85728	
12J-5-71	85733		22046485	85710		680677	85728		T14-1081	85729	
12J-5-9	85700		22052014	85702		680680	85729		T14-1082	85727	

MOTORCRAFT

Motorcraft	Gabriel	Upgrade	Motorcraft	Gabriel	Upgrade	Motorcraft	Gabriel	Upgrade	Motorcraft	Gabriel	Upgrade
AA-229	G63773		ASH-1131	G63622		ASH-29	83314		ASH-712	69575	
AA-450	G63773		ASH-1132	G63622		ASH-294	83209	89414	ASH-824	G63929	
AA-456	G63772		ASH-1135	G63623		ASH-32	83125		ASHV-1	G63678	
AA-457	G63678		ASH-1136	83178		ASH-322	77969		ASHV-1015	G63622	
AA-483	G63837		ASH-1154	83177		ASH-324	77968		ASHV-1025	G63623	
AA-484	G63837		ASH-1155	G63623		ASH-335	G63969		ASHV-1028	G63778	
AA-485	G63837		ASH-119	G63809		ASH-36	85716		ASHV-1046	G63772	
AA-486	G63607		ASH-120	G63837		ASH-362	G63607		ASHV-1047	G63607	
AA-494	83131		ASH-1205	83209	89414	ASH-363	G63525		ASHV-1048	G63525	
AA-500	G63809		ASH-1206	83122		ASH-364	G63524		ASHV-1049	G63524	
AA-501	G63809		ASH-121	G63607		ASH-365	G63772		ASHV-1050	G63608	
AA-502	G63614		ASH-122	G63614		ASH-366	G63608		ASHV-1051	G63837	
AA-503	G63614		ASH-1228	83209	89414	ASH-38	85314	89425	ASHV-13	G63676	
AA-504	G63614		ASH-1230	83122	89406	ASH-387	G63809		ASHV-14	G63837	
AA-615	83135		ASH-132	G63614		ASH-39	85001	89410	ASHV-3	G63714	
AA-616	83175		ASH-137	83122	89406	ASH-391	G63809		ASHV-4	G63716	
AA-617	85928		ASH-23454	G63614		ASH-394	G63614		ASHV-6	G63809	
AS-1086	G63678		ASH-23458	G63614		ASH-397	83131		ASHV-864	G63929	
AS-413	G63414		ASH-24401	G63809		ASH-398	85928		ASHV-865	G63808	
AS-433	G63406		ASH-24402	85928		ASH-407	G63809		ASHV-866	G63810	
AS-485G	G63622		ASH-24433	G63837		ASH-408	G63809		ASHV-867	G63455	
AS-498G	G63608		ASH-24434	G63607		ASH-51	G63773		ASHV-868	G63406	
AS-500G	G63624		ASH-24492	83175		ASH-684	G63623		ASHV-871	G63809	
ASH-1022	83209	89414	ASH-24659	85181		ASH-69	83175		ASHV-879	G63455	
ASH-1023	83122	89406	ASH-24660	85180		ASH-706	G63614		AST-260	G63929	
ASH-1130	G63622		ASH-25	83309	89446	ASH-707	G63614		AT-163G	83177	

Important Note: Competitive Interchanges are to be used for stocking purposes only. Where multiple crosses are identified, please reference the applications section of this catalog. / **Remarque importante:** Les interchanges concurrentiels ne s'utilisent qu'aux fins de stocks. Dans le cas de références multiples, consulter la section des applications du catalogue. / **Nota importante:** Dans le cas de références multiples, consulter la section des applications du catalogue. / **Nota importante:** Se pueden usar intercambios competitivos para propósitos de almacenamiento solamente. Cuando se identifican intercambios múltiples, consulte la sección de aplicaciones de este catálogo.

COMPETITIVE & O.E.M. INTERCHANGE LIST
Lista de Intercambios contra Competidores y Equipo Original.
Liste d'interchange de produits compétitifs & d'équipement original (OEM)

MOTORCRAFT... cont'd

Motorcraft	Gabriel	Upgrade	Motorcraft	Gabriel	Upgrade	Motorcraft	Gabriel	Upgrade	Motorcraft	Gabriel	Upgrade
AT-164G	83178		CAH-069	83219		CAT-899	G63500		CAX-001	85307	
AT-504G	G63679		CAH-069	85301		CAT-900	G63386		CAX-707	83215	
AT-506G	G63679		CAHL-400	85303	89422	CAT-901	G63387		CAX-707	85001	89410
AT-507G	G63607		CAHL-400	85700		CAT-904	G63299		CAX-710	83209	89414
AT-546	G63678		CAHL-405	85300	89419	CAT-905	G63405		CAX-720	85003	89411
AT-547	G63775		CAHL-406	85004		CAT-906	G63396		CAX-811	83312	89409
AT-554	85305		CAHL-409	85310	89423	CAT-907	G63511		CAX-828	83207	89407
AT-568	G63622		CAHL-417	85311	89424	CAT-909	G63398		CAX-828	85012	89413
AT-579	G63809		CAT-722	83400		CAT-910	G63413		CAX-833	83303	
AT-610	G63461		CAT-729	G63414		CAT-911	G63350		CAX-833	85005	89430
AT-611	G63461		CAT-730	G63386		CAT-912	G63625		CAX-841	83216	
AT-620	83209	89414	CAT-731	G63409		CAT-919	G63411		CAX-860	83308	89435
AT-621	83122	89406	CAT-732	G63455		CAT-920	G63675		CAX-861	83309	89446
AT-682	G63678		CAT-733	G63617		CAT-926	G63410		CAX-863	83314	
AT-683	G63679		CAT-736	G63394		CAT-927	G63409		CAX-878	83221	
AT-684	G63679		CAT-737	G63502		CAT-927	G63690		CAX-886	83207	89407
AT-685	G63679		CAT-739	G63603		CAT-928	G63410		CAX-886	85014	
AT-696	83140		CAT-740	G63423		CAT-929	G63403		CAX-891	83215	
AT-710	G63809		CAT-741	G63489		CAT-930	G63461		CAX-891	85314	89425
AT-713	G63614		CAT-745	G63608		CAT-932	G63398		CAX-893	83203	89436
AT-715	G63614		CAT-745	G63614		CAT-935	G63424		CAX-893	85000	89436
AT-716	G63809		CAT-750	G63359		CAT-936	G63425		CAX-893	85043	
AT-764	G63678		CAT-751	G63607		CAT-944	G63347		CAX-894	83209	89414
AT-765	G63772		CAT-758	G63909		CAT-944	G63908		CAX-894	85005	89430
AT-766	83209	89414	CAT-759	G63624		CAT-945	G63421		CAX-894	85013	89414
AT-811	83135		CAT-760	G63622		CAT-945	G63457		CAX-898	83125	
AX-131A	83217		CAT-761	G63623		CAT-948	G63909		CAX-898	85006	
AX-135A	G63406		CAT-762	G63638		CAT-953	G63375		CAX-912	83304	
AX-267A	83309	89446	CAT-768	83209	89414	CAT-953	G63900		CAX-913	83303	
AX-269A	83308	89435	CAT-776	G63661		CAT-953	G63903		CAX-916	83123	89405
AX-269A	83312	89409	CAT-777	G63662		CAT-955	G63454		CAX-916	85036	89405
AX-277A	83219		CAT-778	G63673		CAT-958	G63377		CAX-921	83318	
AX-282A	85010		CAT-793	G63414		CAT-960	G63366		CAX-923	83102	
AX-310	83215		CAT-802	G63419		CAT-963	G63427		CAX-923	83456	89447
AX-327	G63773		CAT-802	G63492		CAT-963	G63525		CAX-924	83317	
AX-332	85928		CAT-802	G63928		CAT-964	G63420		CAX-957	83217	
AX-79A	83221		CAT-803	G63306		CAT-964	G63456		CAX-957	83225	
AX-79A	85030	89440	CAT-817	G63355		CAT-972	G63610		CAX-969	83221	
AX-97A	83122	89406	CAT-824	G63349		CAT-975	G63511		CAX-969	85011	
AX-97A	85005	89430	CAT-826	G63187		CAT-976	G63490		CAX-969	85030	89440
CAH-001	85307		CAT-828	G63494		CAT-977	G63915		CLT-109	G63614	
CAH-001	85711		CAT-831	G63359		CAT-978	G63460		CLT-112	G63525	
CAH-003	83215		CAT-832	G63353		CAT-983	G63489		CLT-113	G63524	
CAH-006	85304		CAT-839	G63357		CAT-984	G63609		CLT-114	G63635	
CAH-012	85736		CAT-853	G63183		CAT-984	G63818		CLT-116	G63902	
CAH-025	85007	89412	CAT-854	G63389		CAT-985	G63488		CLT-124	G63610	
CAH-028	85302	89420	CAT-868	G63360		CAT-986	G63489		CLT-138	G63502	
CAH-029	85308	89422	CAT-895	83207	89407	CAT-990	G63906				

MUNCIE RECLAMATION

O.E.M #	Gabriel	Upgrade	O.E.M #	Gabriel	Upgrade	O.E.M #	Gabriel	Upgrade	O.E.M #	Gabriel	Upgrade
665459	89447		MR1623	85700		MR2961	85701		MR3307	85707	
665568	85051		MR1710	85713		MR2996	85704		MR3650	85707	
665569	85045		MR1751	85713		MR2997	85703		MR6394	85723	
680334	85709		MR1763	85300	89419	MR3303	85709				
97-2210-00164	85708		MR1765	85713		MR3304	85710				
H53-20415-006	85051		MR25767	85702		MR3304H	85709				
H53-21144-004	85045		MR2960	85702		MR3306	85705	89447			

Important Note: Competitive Interchanges are to be used for stocking purposes only. Where multiple crosses are identified, please reference the applications section of this catalog. / **Remarque importante:** Les interchanges concurrentiels ne s'utilisent qu'aux fins de stocks. Dans le cas de références multiples, consulter la section des applications du catalogue. / **Nota importante:** Dans le cas de références multiples, consulter la section des applications du catalogue. / **Nota importante:** Se pueden usar intercambios competitivos para propósitos de almacenamiento solamente. Cuando se identifican intercambios múltiples, consulte la sección de aplicaciones de este catálogo.

COMPETITIVE & O.E.M. INTERCHANGE LIST
Lista de Intercambios contra Competidores y Equipo Original.
Liste d'interchange de produits compétitifs & d'équipement original (OEM)

MUNCIE RECLAMATION... cont'd

O.E.M #	Gabriel	Upgrade	O.E.M #	Gabriel	Upgrade	O.E.M #	Gabriel	Upgrade	O.E.M #	Gabriel	Upgrade
MR6535	85708		MR6536	85722		MR7388	85710				

NATIONAL COACH CORP

O.E.M #	Gabriel	Upgrade	O.E.M #	Gabriel	Upgrade	O.E.M #	Gabriel	Upgrade	O.E.M #	Gabriel	Upgrade
C800853	83207	89407									

NEOPLAN BUS

O.E.M #	Gabriel	Upgrade	O.E.M #	Gabriel	Upgrade	O.E.M #	Gabriel	Upgrade	O.E.M #	Gabriel	Upgrade
24-1700-106-149	83216		AA1002002	85705	89447	BN1002002	85009		DZ1002002	85705	89447
24-1700-999-362	85009		AA1002003	85705	89447	BT1002011	83216		GJ1002002	85706	
25-1700-101-426	85705	89447	AA1802002	85705	89447	CI 1002003	85705	89447	GJ1002003	85705	89447
680307	85705	89447	AC1002002	85705	89447	CL1002003	85705	89447	MM1002002	85705	89447
680308	85706		AC1002002GS	85705	89447	DT1002002	85707		MM1002003	85705	89447
97-9999-02519	85707		AC1002003	85705	89447	DT1802002	85705	89447			

NEW FLYER

O.E.M #	Gabriel	Upgrade	O.E.M #	Gabriel	Upgrade	O.E.M #	Gabriel	Upgrade	O.E.M #	Gabriel	Upgrade
009863	85722		203398	85346		68037840B	85720		69536640Y	85732	
015813	85708		204428	85347		68050440X	85716		97-2210-00164	85708	
015915	85711		68027440Y	85716		68050640Y	85718		G1011823	85710	
016415	85722		680346	85722		680671	85708				
064845	85711		68035041Y	85710		690102	85711				
152959	85708		680352	85711		69536140Y	87016				

NEWMAR CORP

O.E.M #	Gabriel	Upgrade	O.E.M #	Gabriel	Upgrade	O.E.M #	Gabriel	Upgrade	O.E.M #	Gabriel	Upgrade
141700131809	85029		16-16736-000	85029		16-16874-000	83160		481700000493	85900	
141700131810	83160		16-16737-000	83160		16-18103-000	85900				

NISSAN

O.E.M #	Gabriel	Upgrade	O.E.M #	Gabriel	Upgrade	O.E.M #	Gabriel	Upgrade	O.E.M #	Gabriel	Upgrade
56101-30Z01	83161		56110-30Z01	83161		56110-Z5008	83114		56210-Z5001	85085	
56101-30Z02	G63610		56110-30Z02	G63610		56110-Z5011	G63610		66400	G63432	
56101-Z5008	83114		56110-T8123	G63432		56110-Z5017	83162				
56101-Z5017	83162		56110-T8129	G63432		56201-Z5001	85085				

NOVA BUS

O.E.M #	Gabriel	Upgrade	O.E.M #	Gabriel	Upgrade	O.E.M #	Gabriel	Upgrade	O.E.M #	Gabriel	Upgrade
12J-5-10	85733		680231	85313		97-2201-00151	85700		G1205763-001	87019	
12J-5-11	85313		680232	85733		97-9999-02514	85700		G5008070	85700	
22012079	85701		680323	85700		G1011822	85702		N16248	85377	
22024673	85710		680326	85700		G1011823	85710		N16249	85378	
22045526	85702		680470	85713		G1101590	85713		N21543	85378	
22052014	85702		680480	85377		G1201338	85710		N22212	85700	
481700131250	85377		680481	85378		G1201339	85702		N31830	85378	
481700131252	85378		695117	85701		G1203223	85702		N31831	85377	
4975515	85701		74410	85701		G1205763	87019		OE 10086S	85702	

OLE GRANNING

O.E.M #	Gabriel	Upgrade	O.E.M #	Gabriel	Upgrade	O.E.M #	Gabriel	Upgrade	O.E.M #	Gabriel	Upgrade
1086	83217										

OPTIMA BUS CORP

O.E.M #	Gabriel	Upgrade	O.E.M #	Gabriel	Upgrade	O.E.M #	Gabriel	Upgrade	O.E.M #	Gabriel	Upgrade
1260008	87017		90-2610-SP1	87017							

ORION BUS INDUSTRIES

O.E.M #	Gabriel	Upgrade	O.E.M #	Gabriel	Upgrade	O.E.M #	Gabriel	Upgrade	O.E.M #	Gabriel	Upgrade
010134501-4	85307		010234506	85714		020273547-4	85719		050134508	85718	
010134504-4	85715		020117504	85720		020273548	85719		050134509	85732	
010134505-4	85715		020273541	83203	89436	020273549	85719		050134510	85732	
010134506-4	85717		020273541-4	85000	89436	0501345-11	85718		050134513	85732	
010134508-4	85718		020273544	83203	89436	050134501-4	85716		050230501	85716	
010134509	85717		020273546	85719		050134502-4	85718		050231502-4	85716	
010234503-4	85308	89422	020273547	85719		050134506-4	85718		050231505	85716	

Important Note: Competitive Interchanges are to be used for stocking purposes only. Where multiple crosses are identified, please reference the applications section of this catalog. / **Remarque importante:** Les interchanges concurrentiels ne s'utilisent qu'aux fins de stocks. Dans le cas de références multiples, consulter la section des applications du catalogue. / **Nota importante:** Dans le cas de références multiples, consulter la section des applications du catalogue. / **Nota importante:** Se pueden usar intercambios competitivos para propósitos de almacenamiento solamente. Cuando se identifican intercambios múltiples, consulte la sección de aplicaciones de este catálogo.

COMPETITIVE & O.E.M. INTERCHANGE LIST

Lista de Intercambios contra Competidores y Equipo Original.

Liste d'interchange de produits compétitifs & d'équipement original (OEM)

ORION BUS INDUSTRIES... cont'd

O.E.M #	Gabriel	Upgrade	O.E.M #	Gabriel	Upgrade	O.E.M #	Gabriel	Upgrade	O.E.M #	Gabriel	Upgrade
050231507	85716		20117504	85720		680501	85714		695389	87016	
060131507	87016		20117505	85720		680502	85715		695420	85729	
060131508	87016		665596	85719		680504	85716		695421	87016	
060231508	85717		680091	85303	89422	680505	85717		695440	85729	
070131502	87016		680102	85712		680506	85718		97-9999-02635	85718	
070131506	87016		680271	85714		690102	85711		97-9999-02636	85716	
070231514	85729		680274	85716		695327	85732		A-4890	85712	
070231527	85729		680328	85717		695343	85732		OB020570	85711	
20117501	85720		680352	85711		695347	85732		OB020764	85716	
20117503	85720		680378	85720		695366	85732		OB3166657	85700	

OSHKOSH MOTORS

O.E.M #	Gabriel	Upgrade	O.E.M #	Gabriel	Upgrade	O.E.M #	Gabriel	Upgrade	O.E.M #	Gabriel	Upgrade
12405F	85734		1745500		89430	40-4951	85316	89426	665060	83122	89406
12405F-1	85303	89422	2034140	646177		40-5348	85058	89431	690049	85303	89422
12405FX1	85303	89422	2173340	85303	89422	40-6967	85030	89440	90044448	85051	
1398980	83127		26228-A	83122	89406	4036892	G63605		GBL654875	83117	
1445910	85300	89419	2JD137	83119		5353054	85303	89422	GBL654918	83118	
1573270	83207	89407	3638112	G63183		5361994	85734		P117099	83120	
1573280	83221		40-0242	83312	89409	651444	83221		P117146	83118	
1583470	85051		40-4845	85304		665040	85303	89422	RW24285	83119	

OSHKOSH MOTORS CAB SHOCKS

O.E.M #	Gabriel	Upgrade	O.E.M #	Gabriel	Upgrade	O.E.M #	Gabriel	Upgrade	O.E.M #	Gabriel	Upgrade
1202-0054	83021		2218640	83009							

OSTERLUND TRUCK

O.E.M #	Gabriel	Upgrade	O.E.M #	Gabriel	Upgrade	O.E.M #	Gabriel	Upgrade	O.E.M #	Gabriel	Upgrade
220-S5-10	85712		59011	83214		680117	85300	89419			

OTTAWA TRUCK

O.E.M #	Gabriel	Upgrade	O.E.M #	Gabriel	Upgrade	O.E.M #	Gabriel	Upgrade	O.E.M #	Gabriel	Upgrade
53540451	85300	89419	59011	83214		90013787	85310	89423	9007342	85303	89422
59009	83217		680117	85300	89419	90027577	85720				

PACCAR

O.E.M #	Gabriel	Upgrade	O.E.M #	Gabriel	Upgrade	O.E.M #	Gabriel	Upgrade	O.E.M #	Gabriel	Upgrade
665633	85033	89427									

PACIFIC TRUCK & TRAILER

O.E.M #	Gabriel	Upgrade	O.E.M #	Gabriel	Upgrade	O.E.M #	Gabriel	Upgrade	O.E.M #	Gabriel	Upgrade
3178157C	85735		507202C1	85030	89440						

PAGE SUSPENSION

O.E.M #	Gabriel	Upgrade	O.E.M #	Gabriel	Upgrade	O.E.M #	Gabriel	Upgrade	O.E.M #	Gabriel	Upgrade
1080099	83203	89436	665133	83203	89436	A-2212	85029				
1081933	83204		665267	85029							

PAI CORP

O.E.M #	Gabriel	Upgrade	O.E.M #	Gabriel	Upgrade	O.E.M #	Gabriel	Upgrade	O.E.M #	Gabriel	Upgrade
HSA-5067	85305		HSA-5080	83221		HSA-5095	83215				

PEERLESS TRAILER

O.E.M #	Gabriel	Upgrade	O.E.M #	Gabriel	Upgrade	O.E.M #	Gabriel	Upgrade	O.E.M #	Gabriel	Upgrade
120-1	83125		72-61	83125							

PETERBILT

O.E.M #	Gabriel	Upgrade	O.E.M #	Gabriel	Upgrade	O.E.M #	Gabriel	Upgrade	O.E.M #	Gabriel	Upgrade
02-00376	85302	89420	02-02736PLUS	85302	89420	02-02742	85062	89408	03-05384	85033	89427
02-00495	85302	89420	02-02737	85062	89408	02-03020	85910		03-06084	85033	89427
02-01759	83312	89409	02-02737PLUS	85062	89408	02-04010	85012	89413	03-06084PLUS	85033	89427
02-01787	85062	89408	02-02738	85012	89413	03-01635	85308	89422	03-07281	85311	89424
02-01890	85012	89413	02-02738PLUS	85012	89413	03-04176	85308	89422	03-07420	85336	
02-02061	85013	89414	02-02739	85013	89414	03-04176PLUS	85308	89422			
02-02142	85036	89405	02-02739PLUS	85013	89414	03-04628	85336				
02-02225	85012	89413	02-02740	85036	89405	03-04629	85311	89424			
02-02736	85302	89420	02-02741	85012	89413	03-05106	85033	89427			

Important Note: Competitive Interchanges are to be used for stocking purposes only. Where multiple crosses are identified, please reference the applications section of this catalog. / Remarque importante: Les interchanges concurrentiels ne s'utilisent qu'aux fins de stocks. Dans le cas de références multiples, consulter la section des applications du catalogue. / Nota importante: Dans le cas de références multiples, consulter la section des applications du catalogue. / Nota importante: Se pueden usar intercambios competitivos para propósitos de almacenamiento solamente. Cuando se identifican intercambios múltiples, consulte la sección de aplicaciones de este catálogo.

COMPETITIVE & O.E.M. INTERCHANGE LIST
Lista de Intercambios contra Competidores y Equipo Original.
Liste d'interchange de produits compétitifs & d'équipement original (OEM)

PETERBILT... cont'd

O.E.M #	Gabriel	Upgrade	O.E.M #	Gabriel	Upgrade	O.E.M #	Gabriel	Upgrade	O.E.M #	Gabriel	Upgrade
03-07421	85311	89424	665660	85033	89427	680241	85311	89424	B71-6007	85062	89408
03-07421PLUS	85311	89424	665662	85012	89413	680242	85308	89422	B71-6008	83312	89409
03-07423	85033	89427	665738	85910		680253	85314	89425	B71-6009	83219	89408
03-07423PLUS	85033	89427	665752	85067	89451	680261	85062	89408	B71-6009	85062	89408
03-07424	85311	89424	665762	85012	89413	680279	83209	89414	B71-6010	85023	89415
03-07424PLUS	85311	89424	665783	83123	89405	680280	85906	89407	B71-6011	85062	89408
03-08350	85343		665784	83122	89406	680281	85003	89411	B71-6012	85119	
03-08781	85069	89455	665785	83137		680283	83353		B71-6013	85012	89413
10-12032-002PLUS	85320	89429	665788	85000	89436	680303	85007	89412	B71-6015	85012	89413
10-12542-000PLUS	85901		665826	85069	89455	680348	85012	89413	B71-6016	85012	89413
12887-01	85013	89414	665844	85069	89455	680425	85320	89429	B71-6016A	85012	89413
12887-02	85013	89414	665858	85070	89459	680435	85033	89427	B71-6017	85910	
16-13947-000PLUS	85319	89428	665876	85959		680457	85302	89420	B71-6018	85012	89413
16725-01	83221		665918	85900		680458	85336		B71-6019	85989	
19495-01	83126	89440	665926	85047	89435	680459	85311	89424	B71-6020	85989	
2018987C1PLUS	85003	89411	665927	85901		680473	85319	89428	C71-1002	85067	89451
23-08233	85308	89422	665928	85062	89408	680586	85311	89424	C71-1002PLUS	85067	89451
23-10393	85308	89422	665930	85001	89410	70701PLUS	85900		C71-1011	85069	89455
23-12262	85012	89413	665931	83312	89409	800670	85060		C71-1011PLUS	85069	89455
471700004423	85109		665932	85012	89413	8086053PLUS	85047	89435	C71-1013	85985	
47902-13PLUS	83122	89406	665945	85902		85013A0C	85013	89414	C71-1014	85936	89456
60670-005PLUS	83137		665950	85902		90044011	85004		C71-1016	85067	89451
60670-008	83123	89405	671052	85070	89459	90044025PLUS	83209	89414	C71-1017	85069	89455
60670-008PLUS	83123	89405	671091	85069	89455	90044089PLUS	83124	89407	C71-6000	85067	89451
60680-004	83143		671092	85012	89413	90045605	85109		C71-6002	85311	89424
60680-005	83142		671654	85936	89456	ACHB966	83136		C71-6003	85988	
665133	83203	89436	671699	85937		B71-1000	85031		C71-6004	85343	
665174	85060		671794	85067	89451	B71-1001	85070	89459	C71-6005	85069	89455
665565PLUS	85007	89412	671962PLUS	85936	89456	B71-1002	85001	89410	C71-6015	85067	89451
665617	85031		671963	85937		B71-1003	83312	89409	K374-26PLUS	85001	89410
665632	85013	89414	680026	85302	89420	B71-6000	85959		K374-28PLUS	85314	89425
665633	85033	89427	680027	85308	89422	B71-6002	85012	89413	K374-29PLUS	85310	89423
665655	85062	89408	680185	85308	89422	B71-6003	85029		K374-33PLUS	83312	89409
665656	85012	89413	680237	85303	89422	B71-6004	85084	89460			
665657	85013	89414	680239	85310	89423	B71-6005	85084	89460			
665658	85036	89405	680240	85302	89420	B71-6006	85084	89460			

PETERBILT CAB SHOCKS

O.E.M #	Gabriel	Upgrade	O.E.M #	Gabriel	Upgrade	O.E.M #	Gabriel	Upgrade	O.E.M #	Gabriel	Upgrade
1201-0012	83023		20-16755	83042		654919	83035		R71-6000	83067	
1202-0012	83023		20-19140	83063		96027-1054	83011		R71-6005	83042	
1202-0022	83046		29-02455	83008		PP1058870	83059		R71-6006	83063	
1202-0032	83016		29-06005	83035		PP1059870	83060		R71-6007	83008	
1202-0054	83021		29-06032	83035		PP2582870	83012		R71-6008	83035	
1202-1044	83025		654782	83008		R71-1004	83049		R71-6010	83067	
1202P055	83061		654812	83042		R71-1005	83024				

PIERCE MANUFACTURING INC.

O.E.M #	Gabriel	Upgrade	O.E.M #	Gabriel	Upgrade	O.E.M #	Gabriel	Upgrade	O.E.M #	Gabriel	Upgrade
1445910	85300	89419	40-0242	83312	89409	40-4951	85316	89426	40-6967	85030	89440
2034140	646177		40-4845	85304		40-5348	85058	89431	680401	85307	

POWERPACKER CAB SHOCKS

O.E.M #	Gabriel	Upgrade	O.E.M #	Gabriel	Upgrade	O.E.M #	Gabriel	Upgrade	O.E.M #	Gabriel	Upgrade
PP1058870	83059		PP1059870	83060							

PREVOST

O.E.M #	Gabriel	Upgrade	O.E.M #	Gabriel	Upgrade	O.E.M #	Gabriel	Upgrade	O.E.M #	Gabriel	Upgrade
01-0100-905	85303	89422	12L-5-89	85729		19501289	85728				
0822045526	85702		12T-1-13	85303	89422	19501547	85740				
12B-5-1	85735		19501288	85729							

Important Note: Competitive Interchanges are to be used for stocking purposes only. Where multiple crosses are identified, please reference the applications section of this catalog. / **Remarque importante:** Les interchanges concurrentiels ne s'utilisent qu'aux fins de stocks. Dans le cas de références multiples, consulter la section des applications du catalogue. / **Nota importante:** Dans le cas de références multiples, consulter la section des applications du catalogue. / **Nota importante:** Se pueden usar intercambios competitivos para propósitos de almacenamiento solamente. Cuando se identifican intercambios múltiples, consulte la sección de aplicaciones de este catálogo.

COMPETITIVE & O.E.M. INTERCHANGE LIST
Lista de Intercambios contra Competidores y Equipo Original.
Liste d'interchange de produits compétitifs & d'équipement original (OEM)

PREVOST... cont'd

O.E.M #	Gabriel	Upgrade	O.E.M #	Gabriel	Upgrade	O.E.M #	Gabriel	Upgrade	O.E.M #	Gabriel	Upgrade
19501669	85339		481700999386	85736		630163	85330		680492	85713	
19502711	85702		481700999427	85380		630228	85380		680510	85330	
19506846	85339		52001	85708		630234	85329		680555	85330	
196347	85710		63-1013	85329		630235	85330		680583	85380	
196533	85708		630001	85713		630236	85329		690060	85713	
3166657	85700		630080	85713		630251	85379		74939852	85308	89422
481700000206	85380		630091	85736		630252	85329		G1011822	85702	
481700000207	85329		630103	85329		630253	85713		G5008070	85700	
481700000208	85379		630127	85736		630254	85380		N16249	85378	
481700000209	85713		630134	85329		650407	85736		N22212	85700	
481700999376	85329		630136	85330		680323	85700				
481700999377	85330		630161	85736		680422	85329				

RAMERIZ TRAILER

O.E.M #	Gabriel	Upgrade	O.E.M #	Gabriel	Upgrade	O.E.M #	Gabriel	Upgrade	O.E.M #	Gabriel	Upgrade
18165-01	85006										

RAYDAN MANUFACTURING

O.E.M #	Gabriel	Upgrade	O.E.M #	Gabriel	Upgrade	O.E.M #	Gabriel	Upgrade	O.E.M #	Gabriel	Upgrade
14QK-3100	85739		446-51-211	85739		700115	85712				

RED LION TRAILER

O.E.M #	Gabriel	Upgrade	O.E.M #	Gabriel	Upgrade	O.E.M #	Gabriel	Upgrade	O.E.M #	Gabriel	Upgrade
90044978	85059		90045019	85913							

REX MIXER

O.E.M #	Gabriel	Upgrade	O.E.M #	Gabriel	Upgrade	O.E.M #	Gabriel	Upgrade	O.E.M #	Gabriel	Upgrade
102-13441-10	646155										

REYCO SUSPENSION

O.E.M #	Gabriel	Upgrade	O.E.M #	Gabriel	Upgrade	O.E.M #	Gabriel	Upgrade	O.E.M #	Gabriel	Upgrade
12885-01	85300	89419	17794-01	83215		20960-01	83204		665833	85052	
12885-03	85300	89419	18146-01	85313		21310-01	85307		671707	85052	
12886-01	85334		18163-01	83207	89407	21497-01	85005	89430	680551	85738	
12887-01	85013	89414	18164-01	83122	89406	22062-01	85007	89412	680552	85938	
12887-02	85013	89414	18165-01	85006		23106-01	85975		680700	85938	
14954-01	83217		18166-01	85704		23523-01	85086		700098-01	83128	89436
16230-01	85702		18286-01		89414	23524-01	85738		700098-03	85052	
16725-01	83221		18800-01	83203	89436	23553-01	85938		701071-01	665937	
16824-01	85006		19495-01	83126	89440	23614-01	85717		702135-01	85045	
17142-01	85001	89410	19623-01	83123	89405	24392-01	85051		702136-01	85052	
17146-01	83209	89414	19824-01	85006		665519		89414	702209-01	85014	
17358-01	83126	89430	20125-01	85030	89440	665748	85086		704672-01	85938	
17403-01	83122	89406	20126-01		89440	665813	85051				
17408-01	85005	89430	20129-01	85007	89412	665830	85045				

RIDEWELL CORPORATION

O.E.M #	Gabriel	Upgrade	O.E.M #	Gabriel	Upgrade	O.E.M #	Gabriel	Upgrade	O.E.M #	Gabriel	Upgrade
1250005	85901		1267249B000	85712		665267	85029		S2607B	85702	
1250546B000	85006		1267395B000	85302	89420	665526	85014		S4025B	85712	
1250563B000	85000	89436	1270007	85045		680101	85702		S5477B	85307	
1250789B000	85014		1270563B000	85000	89436	70654	85000	89436	S5478B	85307	
1252607B000	85702		1270563B003	85934		90-2610 SP1	87017		S5813B	85704	
1253069B000	85005	89430	1270789B000	85014		AS 4025B	85712		S5878B	83207	89407
1254025B000	85712		1275813B000	85704		AS30698	85005	89430	S6009B	83203	89436
1254190B000	85302	89420	1275943B	85005	89430	AS3069B	85005	89430	S7120B	85304	
1260008	87017		1310002	665937		AS546B	85006		S7172B	83207	89407
12651527B000	85712		1310004	665937		AS563B	83203	89436	S7249B	85307	
1265478B000	85736		1317570B001	646155		AS575B	85005	89430	S7365B	85305	
1266009B000	83130		57645	85005	89430	AS789B	85014				
1267120B000	85734		665198	85005	89430	AS789B000	85014				

Important Note: Competitive Interchanges are to be used for stocking purposes only. Where multiple crosses are identified, please reference the applications section of this catalog. / **Remarque importante:** Les interchanges concurrentiels ne s'utilisent qu'aux fins de stocks. Dans le cas de références multiples, consulter la section des applications du catalogue. / **Nota importante:** Dans le cas de références multiples, consulter la section des applications du catalogue. / **Nota importante:** Se pueden usar intercambios competitivos para propósitos de almacenamiento solamente. Cuando se identifican intercambios múltiples, consulte la sección de aplicaciones de este catálogo.

COMPETITIVE & O.E.M. INTERCHANGE LIST
Lista de Intercambios contra Competidores y Equipo Original.
Liste d'interchange de produits compétitifs & d'équipement original (OEM)

ROADMASTER (MONACO)

O.E.M #	Gabriel	Upgrade	O.E.M #	Gabriel	Upgrade	O.E.M #	Gabriel	Upgrade	O.E.M #	Gabriel	Upgrade
90045132	85909		90045188	85910							

SABO

Sabo	Gabriel	Upgrade	Sabo	Gabriel	Upgrade	Sabo	Gabriel	Upgrade	Sabo	Gabriel	Upgrade
690459	86203		8901026	85064		8901032	85901		890165B	85121	
8901020	85300		8901027	85310		8901033	85918		890414	85323	
8901021	85320		8901028	85316		8901037	86202		890449	85300	
8901023	85066	89448	8901029	85319		8901038	86201		890612	86202	
8901024	85314		8901029	85724	89443	8901156	G63299		895315	83009	
8901025	83128	89436	8901030	85323	89436	890120	85300		895316	83002	
8901025	85000	89436	8901031	85900		890164B	85179				

SACHS

Sachs	Gabriel	Upgrade	Sachs	Gabriel	Upgrade	Sachs	Gabriel	Upgrade	Sachs	Gabriel	Upgrade
101892	85708		315392	85007	89412	315554	85006		410025	83215	
101968	85708		315393	85331		315555	83038		410026	85918	89449
106-884	85708		315394	85921		315556	85314	89425	410032	85320	89429
106282	85722		315395	85724	89443	315593	85029		410035	85001	
106884	85708		315396	85335		315594	85029		410035	85337	
106885	85722		315397	83120		315597	85959		410036	85061	89450
112-885	85709		315398	85058	89431	315598	85933	89454	410037	85081	
124693	85708		315399	85005	89430	315600	85959		410038	85100	
141700000373	85061	89450	315400	85006		315601	85920		410040	85005	89430
141700000377	83174		315403	85919		315602	85092		410042	85310	89423
141700000378	83160		315404	85900		315603	83134		410043	85957	
141700000380	85061	89450	315406	85918	89449	315606	85061	89450	410044	85031	
141700000443	85066	89448	315411	83128		315607	85061	89450	410046	83136	
141700000800	85179		315414	85959		315608	85061	89450	410047	85071	
141700000901	83165		315415	85933	89454	315609	85066	89448	410048	83207	
141700002626	85061	89450	315416	85003	89411	315610	83026		410048	83304	
141700005838	85098		315417	85923		315611	85337		410048	85014	
141700005839	85098		315418	83456	89447	315612	85006		410050	85121	
141700125243	85089		315420	85014		315613	85030	89440	410051	85108	
141700125275	83165		315421	85088		315614	85097		410052	85096	
141700131809	85029		315423	83127		315615	83027		410053	85095	
141700131810	83160		315424	85067	89451	315616	83038		410056	85000	89436
141700131975	83160		315425	85330		315618	83160		410057	83137	
170210	83104		315426	85329		315619	83160		410058	83122	
170211	83104		315427	85713		315620	85080		410068	85030	89440
280499	85300	89419	315428	85380		315621	85080		410068	85054	
290146	85012	89413	315430	85099		315622	85081		410069	83165	
290460	85005	89430	315431	85014		315623	85918		410069	85094	
290465	83125		315432	89414		315625	85975		410070	85089	
290488	85040		315434	85065		315626	85933	89454	471700000426	85014	
311229	85918	89449	315435	85088		315656	83040		471700000428	85006	
311230	85956		315540	83613		315657	83039		471700000431	85066	89448
311631	85906	89407	315541	85052		315658	83057		471700000433	85099	
311632	85909		315542	83122	89406	315659	83047		471700000436	85030	89440
311633	85900		315543	83125		315660	83009		471700000440	85959	
311634	85001	89410	315544	85014		315661	85932	89453	471700000443	85066	89448
311635	85030	89440	315545	85333		40-A85-0	85708		471700000445	85080	
311793	85975		315546	85005	89430	410 011	83173		471700000447	85919	
311794	85974		315547	85924	89457	410 038	85100		471700000449	85918	89449
312724	85311		315548	85070	89459	410010	83317		471700000451	85080	
313708	85378		315549	85033	89427	410011	85093		471700000458	85014	
313709	85377		315550	85311	89424	410021	83125				
315389	85090		315551	85310	89423	410022	85006				
315390	85958		315552	83128		410023	85103				
315391	85956		315553	85900		410024	85302	89420			

Important Note: Competitive Interchanges are to be used for stocking purposes only. Where multiple crosses are identified, please reference the applications section of this catalog. / **Remarque importante:** Les interchanges concurrentiels ne s'utilisent qu'aux fins de stocks. Dans le cas de références multiples, consulter la section des applications du catalogue. / **Nota importante:** Dans le cas de références multiples, consulter la section des applications du catalogue. / **Nota importante:** Se pueden usar intercambios competitivos para propósitos de almacenamiento solamente. Cuando se identifican intercambios múltiples, consulte la sección de aplicaciones de este catálogo.

COMPETITIVE & O.E.M. INTERCHANGE LIST
Lista de Intercambios contra Competidores y Equipo Original.
Liste d'interchange de produits compétitifs & d'équipement original (OEM)

SACHS... cont'd

Sachs	Gabriel	Upgrade	Sachs	Gabriel	Upgrade	Sachs	Gabriel	Upgrade	Sachs	Gabriel	Upgrade
47170000459	85030	89440	471700004270	85117		481700000208	85379		510003	85004	
47170000460	85097		471700004423	85109		481700000209	85713		510004	85307	
47170000461	89414		471700005079	85005	89430	481700000477	85900		510005	85303	
47170000464	85090		471700006039	85088		481700000483	85975		510006	85705	
47170000466	85959		471700006040	85088		481700000484	85974		510006	85706	
47170000470	85918	89449	471700006048	83165		481700000485	85975		510009	85711	
47170000802	85121		471700006269	85932	89453	481700000493	85900		510011	87020	
471700002580	83165		471700009646	85088		481700004271	85993		510017	85323	89436
471700002627	85066	89448	471700009647	85088		481700004476	85982		510018	85724	89443
471700002726	85918	89449	471700011530	85181		481700005414	85179		510019	85916	
471700002809	85724	89443	471700011531	85180		481700008558	85347		510023	85316	89426
471700002861	85014		471700125245	85089		481700008666	87020		510024	85381	
471700002919	85106		471700131155	85918	89449	481700125969	85956		510039	85982	
471700002990	85007		471700131256	85065		481700131250	85377		510040	85110	
471700002991	85959		471700131258	85081		481700131252	85378		814903003482	83040	
471700002992	85331		471700131331	85932	89453	481700131438	85919		814903003483	83039	
471700002993	85921		471700131545	85006		481700131919	85900		814903003484	83057	
471700002994	83134		471700131646	85918	89449	481700999376	85329		814903003486	83047	
471700002995	83134		471700131775	85006		481700999377	85330		814903003496	83009	
471700002996	85335		471700131920	85933	89454	481700999386	85376		814903003500	83026	
471700003009	85006		471700131921	85933	89454	481700999427	85380		814903003501	83027	
471700003011	85058		471700131974	85029		510001	85716		814903003528	83038	
471700003832	85933	89454	481700000206	85380		510002	85302	89420	823196420	85100	
471700003920	85958		481700000207	85329		510002	85983				

SAF HOLLAND

O.E.M #	Gabriel	Upgrade	O.E.M #	Gabriel	Upgrade	O.E.M #	Gabriel	Upgrade	O.E.M #	Gabriel	Upgrade
471700000433	85099		90044012	85006		90044868	85045		90045099	85906	89407
471700000436	85030		90044016	85300	89419	90044878	83635		90045110	83137	
471700000458	85014		90044017	83204		90044907	83635		90045132	85909	
471700000459	85030		90044025	83209	89414	90044915	83127		90045138	85910	
471700000460	85097		90044046	83123	89405	90044977	83115		90045175	85916	
471700000461		89414	90044071	85000	89436	90044978	85059		90045188	85910	
481700000483	85975		90044081	85000	89436	90044979	83113		90045207		89405
481700000484	85974		90044086	85000	89436	90044980	85907		90045277	85030	
481700000485	85975		90044089	83124	89407	90044981	85000	89436	90045298	83128	
57639	85000	89436	90044089C	83124	89407	90044982	85000	89436	90045299	83389	89436
57643	85013	89414	90044095	83203	89436	90044991	85000	89436	90045331	646155	
6025	83122	89406	90044162	83128	89436	90044992	85000	89436	90045336	85014	
6026	83204		90044448	85051		90045000	85906	89407	90045337	85911	
632155	646177		90044625	83125		90045001	85323	89436	90045338	85060	
646201	646177		90044626	83126	89430	90045002	85906	89407	90045381	83150	
665002	85004		90044642	83127		90045003	85323	89436	90045384		89430
665003	85300	89419	90044679	83122	89406	90045019	85913		90045418	85916	
665197	85051		90044680	83125		90045028	85907		90045419		89405
665454	85045		90044681	83204		90045031	85968		90045420		89440
665514	83127		90044682	83209	89414	90045040	83130		90045432	85321	
665969		89430	90044683	83122	89406	90045048	85905		90045433	85916	
671921	85916		90044684	83124	89407	90045049	85905		90045455	85909	
671922		89405	90044685	83389	89439	90045050	85914		90045466		89406
671923		89440	90044686	85051		90045053	85908		90045471	83150	
671931	85916		90044687	83125		90045054	85051		90045499	85974	
680234	85906	89407	90044688	83122	89406	90045068		89441	90045500	85975	
680268	85323	89436	90044769	83207	89407	90045075	85911		90045503	85975	
680645	85321		90044770	83207	89407	90045080	85912				
90044001	85005	89430	90044794	83127		90045083	85910				
90044008	85000	89436	90044833	85052		90045084	85968				
90044011	85004		90044834	85052		90045096	85916				

Important Note: Competitive Interchanges are to be used for stocking purposes only. Where multiple crosses are identified, please reference the applications section of this catalog. / **Remarque importante:** Les interchanges concurrentiels ne s'utilisent qu'aux fins de stocks. Dans le cas de références multiples, consulter la section des applications du catalogue. / **Nota importante:** Dans le cas de références multiples, consulter la section des applications du catalogue. / **Nota importante:** Se pueden usar intercambios competitivos para propósitos de almacenamiento solamente. Cuando se identifican intercambios múltiples, consulte la sección de aplicaciones de este catálogo.

COMPETITIVE & O.E.M. INTERCHANGE LIST
Lista de Intercambios contra Competidores y Equipo Original.
Liste d'interchange de produits compétitifs & d'équipement original (OEM)

SAF HOLLAND... cont'd

O.E.M #	Gabriel	Upgrade	O.E.M #	Gabriel	Upgrade	O.E.M #	Gabriel	Upgrade	O.E.M #	Gabriel	Upgrade
90045504	85030		90045574	83130		AR-1008	85006		AR-2451	83203	89436
90045532	85030		90045575	85051		AR-1141	83204		AR-2598	83123	89405
90045533	85099		90045576	83150		AR-1141-C	83204		AR-718-C	83203	89436
90045534	85014		90045605	85109		AR-1202	85300	89419	AR-718-C-HD	85000	89436
90045535	85097		90045607	83150		AR-134-C	85005	89430	AR-781	83203	89436
90045536		89414	90045665	85029		AR-1404	85301		AR-958	83207	89407
90045563	85014		90045666	83130		AR-1425	85301		AR-995	85734	
90045564	83128	89436	90045666	85051		AR-1434	83203	89436	XB-SPN-053-36	83125	
90045568	85060		90045667	85060		AR-1654	83209	89414			
90045572	85045		90045669	83389	89436	AR-1822	85304				

SEAGRAVE FIRE APPARATUS LLC

O.E.M #	Gabriel	Upgrade	O.E.M #	Gabriel	Upgrade	O.E.M #	Gabriel	Upgrade	O.E.M #	Gabriel	Upgrade
680117	85300	89419	P0025500	85300	89419						

SICARD

O.E.M #	Gabriel	Upgrade	O.E.M #	Gabriel	Upgrade	O.E.M #	Gabriel	Upgrade	O.E.M #	Gabriel	Upgrade
3166657	85700										

SPARTAN MOTORS

O.E.M #	Gabriel	Upgrade	O.E.M #	Gabriel	Upgrade	O.E.M #	Gabriel	Upgrade	O.E.M #	Gabriel	Upgrade
0272-SS5	85712		471700000456	85959		78068	85304		B46-2151	85007	89412
0346-SS5	85013	89414	58913-009	85959		AS 4025B	85712				
0377-SS5	85029		59011	83214		B46-1594	85013	89414			
21310-01	85307		60665-025	85036		B46-1725	85029				

SPRING VALLEY

O.E.M #	Gabriel	Upgrade	O.E.M #	Gabriel	Upgrade	O.E.M #	Gabriel	Upgrade	O.E.M #	Gabriel	Upgrade
632155	646177										

STERLING TRUCK

O.E.M #	Gabriel	Upgrade	O.E.M #	Gabriel	Upgrade	O.E.M #	Gabriel	Upgrade	O.E.M #	Gabriel	Upgrade
10-12388-000	85920		AX-310	83215		F4HT-18080-BA	85001	89410	F6HT-18080-CA	85314	89425
10-12390-000	85920		C4HZ-18124-E	83309	89446	F5HZ-18124-A	83314		F6HT-18080-DA	83109	
10-13592-000	85959		C4TZ-18124-AB	83308		F5HZ-18124-B	83107		F6HT-18080-EA	85906	89407
1210-0528	85904		D8HZ-18124-A	85301		F5HZ-18124-C	85063		F6HT-18080-FC	85013	89414
16-13957-000	85724	89443	E6HZ-18124-A	85301		F5HZ-18124-D	83125		F6HT-18124-JC	83200	89402
16-15770-000	85956		E6HZ-18124-D	85301		F5HZ-18125-A	85314	89425	F6HT-18124-KA	83200	89402
16-15817-000	85724	89443	E6HZ-18125-D	83215		F5HZ-18125-B	85001	89410	F6HZ-18124-A	85054	89438
16-18708-000	85724	89443	E7HZ-18124-A	85301		F6HT-18045-AA	85054	89438	F6HZ-18124-B	83308	
471700002809	85724	89443	E7XZ-18124-A	G63386		F6HT-18045-AC	85054	89438	F6HZ-18124-C	85055	89439
47902-28	85013	89414	E7XZ-18125-B	G63387		F6HT-18045-BC	85047	89435	F6HZ-18124-D	85055	89439
4C4Z-18124-N	85957		E9HZ-18124-A	83309	89446	F6HT-18045-CC	85055	89439	F6HZ-18124-E	85055	89439
4C4Z-18125-DA	85926		F0HZ-18124-B	85006		F6HT-18045-CC	85055	89439	F6HZ-18124-F	85055	89439
57241-2	83109		F1HZ-18124-A	83309	89446	F6HT-18045-EB	85055	89439	F6HZ-18124-G	85054	89438
58913-003	85932	89453	F1HZ-18124-B	83308		F6HT-18045-EC	85055	89439	F6HZ-18124-H	85054	89438
6803230200	85043		F1HZ-18124-D	85006	89401	F6HT-18045-EB	85055	89439	F6HZ-18124-I	85054	89438
6803230300	85006		F1HZ-18124-E	85006	89401	F6HT-18045-GB	85030	89440	F6HZ-18124-J	83200	89402
6803260000	83120		F1HZ-18124-H	85040		F6HT-18045-GC	85030	89440	F6HZ-18124-K	83109	
680611	85724	89443	F1HZ-18124-I	83308		F6HT-18045-HB	85054	89438	F6HZ-18125-B	83109	
6E7Z-18125-A	83146		F1HZ-18124-J	83308		F6HT-18045-HC	85054	89438	F6HZ-18125-D	85013	89414
90045099	85906	89407	F1HZ-18124-K		89402	F6HT-18045-JB	83200	89402	F81A-18045-AGB	G63809	
AT-560	G63809		F2HZ-18124-A	85376		F6HT-18045-JC	83200	89402	SDA471700000440	85959	
AX-267A	83309	89446	F2HZ-18124-B	85301		F6HT-18045-JD	83200	89402	SDA471700002809	85724	89443
			F4HT-18080-AB	85314	89425	F6HT-18045-KA	83200	89402	XC45-18045-AA	83216	
						F6HT-18045-LA	85376		XC45-18080-BA	85724	89443
						F6HT-18080-B	83109				

STERLING TRUCK CAB SHOCKS

O.E.M #	Gabriel	Upgrade	O.E.M #	Gabriel	Upgrade	O.E.M #	Gabriel	Upgrade	O.E.M #	Gabriel	Upgrade
1202-1043	83025		18-45067-000	83034		18-814903003484	83057		F6HZ-5K407-BA	83033	
18-43504-000	83057		18-60768-000	83057		F6HZ-5K407-AB	83034		F8HT-5K407-AA	83033	

STOUGHTON TRAILERS INC.

O.E.M #	Gabriel	Upgrade	O.E.M #	Gabriel	Upgrade	O.E.M #	Gabriel	Upgrade	O.E.M #	Gabriel	Upgrade
HTA20001	83128	89436	NW90044162	83128	89436						
HTA20002	85000	89436	NW90044448	85051							

Important Note: Competitive Interchanges are to be used for stocking purposes only. Where multiple crosses are identified, please reference the applications section of this catalog. / **Remarque importante:** Les interchanges concurrentiels ne s'utilisent qu'aux fins de stocks. Dans le cas de références multiples, consulter la section des applications du catalogue. / **Nota importante:** Dans le cas de références multiples, consulter la section des applications du catalogue. / **Nota importante:** Se pueden usar intercambios competitivos para propósitos de almacenamiento solamente. Cuando se identifican intercambios múltiples, consulte la sección de aplicaciones de este catálogo.

COMPETITIVE & O.E.M. INTERCHANGE LIST
Lista de Intercambios contra Competidores y Equipo Original.
Liste d'interchange de produits compétitifs & d'équipement original (OEM)

STOUGHTON TRAILERS INC.... cont'd

O.E.M #	Gabriel	Upgrade	O.E.M #	Gabriel	Upgrade	O.E.M #	Gabriel	Upgrade	O.E.M #	Gabriel	Upgrade
NW90044978	85059		NW90044979	83113		RT18165-01	85006				

SUSPENSIONS INC.

O.E.M #	Gabriel	Upgrade	O.E.M #	Gabriel	Upgrade	O.E.M #	Gabriel	Upgrade	O.E.M #	Gabriel	Upgrade
200188	646155										

SUSPENSYS

O.E.M #	Gabriel	Upgrade	O.E.M #	Gabriel	Upgrade	O.E.M #	Gabriel	Upgrade	O.E.M #	Gabriel	Upgrade
218004872	85737										

TEREX CORPORATION

O.E.M #	Gabriel	Upgrade	O.E.M #	Gabriel	Upgrade	O.E.M #	Gabriel	Upgrade	O.E.M #	Gabriel	Upgrade
12111	646155										

THE BINKLEY COMPANY

O.E.M #	Gabriel	Upgrade	O.E.M #	Gabriel	Upgrade	O.E.M #	Gabriel	Upgrade	O.E.M #	Gabriel	Upgrade
16965	85006		6898	83125							

THOMAS SCHOOL BUS

O.E.M #	Gabriel	Upgrade	O.E.M #	Gabriel	Upgrade	O.E.M #	Gabriel	Upgrade	O.E.M #	Gabriel	Upgrade
10-13634-000	85918	89449	61300219	85091		614966	85307		8C24-18045-DA	83177	
128745	83102		61300222	85091		614974	85304		8C24-18080-DB	83178	
16-15817-000	85724	89443	61300223	85091		63-0001	85713		8C2Z-18124-D	83177	
16-18708-000	85724	89443	61300224	85918	89449	651442	83102		8C2Z-18125-D	83178	
16-18713-000	85122		61300240	85918	89449	659287	83102		90045504	85030	
16-19138-000	85058	89431	61300285	83102		680-323-0300	85006		A-4890	85712	
300-0614966	85307		6130029	85712		680-326-0000	83120		ASH-1136	83178	
471700003070	85122		61310101	85736		680010	85304		ASH-1154	83177	
471700131545	85006		61310102	85308	89422	680054	85307		AT-163G	83177	
60670-006	83147		61310103	85308	89422	680088	85713		AT-164G	83178	
60998-001	85006		61310104	85713		680102	85712		GBL651442	83102	
60998-003	85006		61310232	85000	89436	70445	85091		GBL654725	83120	
6130-0114		89437	61310434	85724	89443	728802	85736		GBL665538	85006	
61300112	83613		61310478	85724	89443	87002	85736				

THOR MOTOR COACH

O.E.M #	Gabriel	Upgrade	O.E.M #	Gabriel	Upgrade	O.E.M #	Gabriel	Upgrade	O.E.M #	Gabriel	Upgrade
141700131809	85029		16-16736-000	85029		16-16873-000	85029		16-18103-000	85900	
141700131810	83160		16-16737-000	83160		16-16874-000	83160		481700000493	85900	

TIMBREN INDUSTRIES

O.E.M #	Gabriel	Upgrade	O.E.M #	Gabriel	Upgrade	O.E.M #	Gabriel	Upgrade	O.E.M #	Gabriel	Upgrade
665804	85939										

TRAILMOBILE CANADA CORP.

O.E.M #	Gabriel	Upgrade	O.E.M #	Gabriel	Upgrade	O.E.M #	Gabriel	Upgrade	O.E.M #	Gabriel	Upgrade
43-4-235	85051		43-6-028	85000	89436	43-8-014	85013	89414	90044978	85059	
43-4-236	85029		43-6-118	85000	89436	43-8-015	85006		90044979	83113	
43-4-237	85000	89436	43-6-137	85006		43-8-022	83225		90044992	85000	89436
43-4-239	83207	89407	43-6-158	85013	89414	43-8-031	85029		90045054	85051	
43-4-241	85006		43-6-164	83207	89407	90044089	83124	89407	A-2212	85029	
43-4-277	85000	89436	43-8-002	83209	89414	90044625	83125				
43-4-278	85059		43-8-011	83207	89407	90044642	83127				
43-4-279	83204		43-8-013	85000	89436	90044977	83115				

TRANSPORTATION MFG. CORP

O.E.M #	Gabriel	Upgrade	O.E.M #	Gabriel	Upgrade	O.E.M #	Gabriel	Upgrade	O.E.M #	Gabriel	Upgrade
12-05-6000	85711		12J-5-4	85312		22024673	85710		695273	85710	
12-05-6002	85339		12J-5-6	85313		22045526	85702		695279	85710	
12-05-6033	85339		12J-5-9	85700		22046485	85710		74410	85701	
12B-5-1	85735		12L-5-69	85700		22052014	85702		G1011822	85702	
12G-5-1	85700		12L-5-70	85700		4975515	85701		G1101590	85713	
12J-5-10	85733		12L-5-99	85339		680349	85702				
12J-5-11	85313		12T-1-13	85303	89422	680350	85710				
12J-5-2	85312		12TA-01-13	85303	89422	680470	85713				
12J-5-3	85313		22012079	85701		695117	85701				

Important Note: Competitive Interchanges are to be used for stocking purposes only. Where multiple crosses are identified, please reference the applications section of this catalog. / **Remarque importante:** Les interchanges concurrentiels ne s'utilisent qu'aux fins de stocks. Dans le cas de références multiples, consulter la section des applications du catalogue. / **Nota importante:** Dans le cas de referencias multiples, consultar la sección de aplicaciones del catálogo. / **Nota importante:** Se pueden usar intercambios competitivos para propósitos de almacenamiento solamente. Cuando se identifican intercambios múltiples, consulte la sección de aplicaciones de este catálogo.

COMPETITIVE & O.E.M. INTERCHANGE LIST
Lista de Intercambios contra Competidores y Equipo Original.
Liste d'interchange de produits compétitifs & d'équipement original (OEM)

TRANSPORTATION MFG. CORP... cont'd

TRUCKMASTER

Truckmaster	Gabriel	Upgrade	Truckmaster	Gabriel	Upgrade	Truckmaster	Gabriel	Upgrade	Truckmaster	Gabriel	Upgrade
665632	85013	89414	665930	85001	89410	680240	85302	89420	680303	85007	89412
665633	85033	89427	665931	83312	89409	680241	85311	89424	680348	85012	89413
665783	83123	89405	665932	85012	89413	680242	85308	89422	680385	85311	89424
665784	83122	89406	665950	85902		680243	85001	89410	680425	85320	89429
665785	83137		671052	85070	89459	680253	85314	89425	680435	85033	89427
665844	85069	89455	671654	85936	89456	680261	85062	89408	680473	85319	89428
665918	85900		671699	85937		680279	83209	89414	680586	85311	89424
665926	85047	89435	671794	85067	89451	680280	85906	89407	680601	85012	89413
665927	85901		680237	85303	89422	680281	85003	89411			
665928	85062	89408	680239	85310	89423	680283	83353				

TUTHILL TECHNOLOGIES

O.E.M #	Gabriel	Upgrade	O.E.M #	Gabriel	Upgrade	O.E.M #	Gabriel	Upgrade	O.E.M #	Gabriel	Upgrade
1085	83214		17358-01	83126	89430	19495-01	83126	89440	24392-01	85051	
12885-01	85300	89419	17403-01	83122	89406	19623-01	83123	89405	2697	85712	
12885-03	85300	89419	17408-01	85005	89430	19824-01	85006		66502	646155	
12887-01	85013	89414	17794-01	83215		20125-01	85030	89440	680162	85300	89419
12887-02	85013	89414	18146-01	85313		20126-01		89440	702135-01	85045	
14954-01	83217		18163-01	83207	89407	20129-01	85007	89412	702136-01	85052	
16230-01	85702		18164-01	83122	89406	20960-01	83204		702209-01	85014	
16725-01	83221		18165-01	85006		21497-01	85005	89430	OE12425	83214	
16824-01	85006		18166-01	85704		23524-01	85738				
17142-01	85001	89410	18286-01		89414	23553-01	85938				
17146-01	83209	89414	18800-01	83203	89436	23614-01	85717				

TWIN COACH

O.E.M #	Gabriel	Upgrade	O.E.M #	Gabriel	Upgrade	O.E.M #	Gabriel	Upgrade	O.E.M #	Gabriel	Upgrade
90044089	83124	89407	90044162	83128	89436	AR-958	83207	89407			
90044089C	83124	89407	AR-718-C-HD	85000	89436						

UNITED MANUFACTURING

O.E.M #	Gabriel	Upgrade	O.E.M #	Gabriel	Upgrade	O.E.M #	Gabriel	Upgrade	O.E.M #	Gabriel	Upgrade
K-96-41	85304										

UNIVERSAL COACH

O.E.M #	Gabriel	Upgrade	O.E.M #	Gabriel	Upgrade	O.E.M #	Gabriel	Upgrade	O.E.M #	Gabriel	Upgrade
12-05-1199	85729		680777	85729							

UPS TRUCK

O.E.M #	Gabriel	Upgrade	O.E.M #	Gabriel	Upgrade	O.E.M #	Gabriel	Upgrade	O.E.M #	Gabriel	Upgrade
P117099	83120		P117146	83118							

UTILITY TRAILER MANUFACTURING COMPANY

O.E.M #	Gabriel	Upgrade	O.E.M #	Gabriel	Upgrade	O.E.M #	Gabriel	Upgrade	O.E.M #	Gabriel	Upgrade
B-23361	85911		B-24023	85738		B-24125	85323	89436	S-24088	83128	89436
B-23566	85000	89436	B-24088	83128	89436	B-24579	85939		S-24088	85000	89436
B-23651	85045		B-24088	85000	89436	B-25515	85338				

VAN HOOL

O.E.M #	Gabriel	Upgrade	O.E.M #	Gabriel	Upgrade	O.E.M #	Gabriel	Upgrade	O.E.M #	Gabriel	Upgrade
10685703	695406		6243-14040	85708		665562	85708		90-2291	695406	
6243-13790	85708		624314570	695406		665563	85708				

VARIOUS

O.E.M #	Gabriel	Upgrade	O.E.M #	Gabriel	Upgrade	O.E.M #	Gabriel	Upgrade	O.E.M #	Gabriel	Upgrade
SC-2920	83176										

VOLVO

O.E.M #	Gabriel	Upgrade	O.E.M #	Gabriel	Upgrade	O.E.M #	Gabriel	Upgrade	O.E.M #	Gabriel	Upgrade
02-7005976	83400		1091347	83125		1091351	83209	89414	1091357	83219	
02-7005977	83400		1091348	83122	89406	1091353	83215		1091358	83456	89447
03-1106460	85005	89430	1091349	83204		1091354	83216		1091359	83123	89405
1-0200-32-888-1	83104		1091350	83207	89407	1091355	83217		1091360	83303	

Important Note: Competitive Interchanges are to be used for stocking purposes only. Where multiple crosses are identified, please reference the applications section of this catalog. / **Remarque importante:** Les interchanges concurrentiels ne s'utilisent qu'aux fins de stocks. Dans le cas de références multiples, consulter la section des applications du catalogue. / **Nota importante:** Dans le cas de références multiples, consulter la section des applications du catalogue. / **Nota importante:** Se pueden usar intercambios competitivos para propósitos de almacenamiento solamente. Cuando se identifican intercambios múltiples, consulte la sección aplicaciones de este catálogo.

COMPETITIVE & O.E.M. INTERCHANGE LIST
Lista de Intercambios contra Competidores y Equipo Original.
Liste d'interchange de produits compétitifs & d'équipement original (OEM)

VOLVO... cont'd

O.E.M #	Gabriel	Upgrade	O.E.M #	Gabriel	Upgrade	O.E.M #	Gabriel	Upgrade	O.E.M #	Gabriel	Upgrade
1091361	83304		22046483	85304		3199991	85708		3919593	83242	
1091362	83309	89446	22052336	85304		3199992	85733		3919594	85003	89411
1091363	83221		3082284	83400		3199993	85712		3919596	G63484	
1091364	83312	89409	3092842	85061	89450	3199994	85308	89422	3919598	83312	89409
1091365	83400		3130140	85315		35901-0001	83209	89414	3919900	85012	89413
1091366	83401		3171696	85307		35901-0003	85301		3919901	83103	
1091367	85000	89436	3172948	85303	89422	35901-0004	83219		3919902	83126	89430
1091368	85003	89411	3199937	85316	89426	35901-0005	83219		3919903	83216	
1091370	85006		3199938	85030	89432	35901-0008	85060		3919904	G63183	
1091371	85300	89419	3199939	85058	89431	35901-0011	83123	89405	3919906	83308	
1091372	85301		3199940	85005	89430	35901-0017	83314		3919907	83309	89446
1091373	85302	89420	3199941	85006		35901-0022	83635		3919908	83104	
1091374	85303	89422	3199942		89402	35901-3201	85024	89416	3919909	G63605	
1091375	85304		3199943	85012	89413	35901-3406	85305		3919910	83221	
1091376	85305		3199944	85006		35901-3409	85304		3919911	83124	89407
1091377	85307		3199945	85027	89418	35901-3410	85307		3919912	83215	
1091378	85308	89422	3199946	85033	89427	35901-3413	85006		3919913	83203	89436
1091379	85310	89423	3199947	85013	89414	35901-3420	85303	89422	3919914	83209	89414
1091384	85735		3199948	85311	89424	37001-5	83401		3919915	83127	
1093100	85027	89418	3199949	85310	89423	37301-0001	85013	89414	3919916	83126	89430
1093174	83353		3199950	85023	89415	37301-0008	83400		3919917	83125	
1093176	85024	89416	3199951	85024	89416	37301-0016	85026	89417	3919918	83401	
1093177	85025		3199952	85736		37301-0018	85005	89430	3919919	G63625	
1093178	85026	89417	3199953	85319	89428	37301-0021	85026	89417	3919920	83303	
1093180	85030	89440	3199954	85003	89411	37301-3201	85027	89418	3919921	83123	89405
141700000373	85061	89450	3199955	85300	89419	37301-3202	85026	89417	3919922	83318	
141700005838	85098		3199956	85036	89405	3915917	85319	89428	3919923	83301	
1505190	85722		3199957	83122	89406	3915947	85001	89410	3919924	83456	89447
1590439	83104		3199959	85323	89436	3915948	85311	89424	3919925	83317	
1591501	85722		3199960	85322		3916352	85013	89414	3919926	G63403	
1591735	83104		3199961	85307		3919055	85007	89412	3919927	83101	
1593843	83215		3199962	85314	89425	3919056	83203	89436	3919928	83225	
1716824	85304		3199963	85315		3919057	83225		3919930	83353	
19501669	85339		3199965	85736		3919526	83314		3919931	83126	89430
19502711	85702		3199966	85303	89422	3919561	85314	89425	3919932	85062	89408
19506846	85339		3199967	85302	89420	3919565	83103		3919933	85001	89410
20353932	85081		3199968	85308	89422	3919567	83613		3919934	85320	89429
20414440	85081		3199970	85701		3919568	83636		3919935	85026	89417
20433424	85061	89450	3199972	85320	89429	3919569	85052		3919936	83207	89407
20433425	85066	89448	3199973	85722		3919570	83128		3919937	85316	89426
20433426	85081		3199974	85712		3919571	83635		3919938	85030	89432
20433427	85065		3199975	85700		3919572	83130		3919939	85058	89431
20434880	85081		3199976	85711		3919573	83123	89405	3919940	85005	89430
20469001	85933	89454	3199977	85711		3919574	85006	89401	3919941	85006	
20469002	85933	89454	3199978	85712		3919575	83120		3919942	89402	
20485632	85933	89454	3199979	85702		3919582	83215		3919943	85012	89413
20485633	85933	89454	3199980	85310	89423	3919583	83100		3919944	85036	
20513881	85061	89450	3199982	85703		3919584	83353		3919945	85027	89418
20551628	85066	89448	3199983	85704		3919585	83209	89414	3919946	85033	89427
20782199	85072		3199984	85314	89425	3919586	83100		3919947	85013	89414
20863239	85080		3199985	85723		3919587	83105		3919948	85311	89424
21137330	85933	89454	3199986	85318		3919588	83216		3919949	85310	89423
21436086	85098		3199987	85705		3919589	85026	89417	3919950	83219	
21462378	85088		3199988	85311	89424	3919590	85042		3919951	83309	89416
21462380	85088		3199989	85709		3919591	83515		3919952	85736	
22012065	85304		3199990	85003	89411	3919592	85024	89416	3919953	85319	89428

Important Note: Competitive Interchanges are to be used for stocking purposes only. Where multiple crosses are identified, please reference the applications section of this catalog. / **Remarque importante:** Les interchanges concurrentiels ne s'utilisent qu'aux fins de stocks. Dans le cas de références multiples, consulter la section des applications du catalogue. / **Nota importante:** Dans le cas de références multiples, consulter la section des applications du catalogue. / **Nota importante:** Se pueden usar intercambios competitivos para propósitos de almacenamiento solamente. Cuando se identifican intercambios múltiples, consulte la sección de aplicaciones de este catálogo.

COMPETITIVE & O.E.M. INTERCHANGE LIST
Lista de Intercambios contra Competidores y Equipo Original.
Liste d'interchange de produits compétitifs & d'équipement original (OEM)

VOLVO... cont'd

O.E.M #	Gabriel	Upgrade	O.E.M #	Gabriel	Upgrade	O.E.M #	Gabriel	Upgrade	O.E.M #	Gabriel	Upgrade
3919954	85003	89411	3946219	83400		6775412	85040		83176224	85062	
3919955	85300	89419	3946239	85724	89443	6790756	83215		83176225	85066	
3919956	85036	89405	3949240	85047	89435	6794358	85040		83176226	85067	
3919957	83122	89406	3949241	85061	89450	6857668	83105		83176227	85069	
3919958	85046	89434	3953643	85040		6876828	83105		83176228	85070	
3919959	85000	89436	3971703	83112		70042	85302	89420	83176229	85303	
3919960	85322		3972662	85976		8026658	85046	89434	83176230	85310	
3919961	85302	89420	47170000443	85066	89448	8056892	85023	89415	83176231	85311	
3919962	85700		471700002627	85066	89448	8060026	85065		83176232	85320	
3919963	85730		471700003832	85933	89454	8065787	85026	89417	83176233	85321	
3919964	85304		471700004423	85109		8071524	85024	89416	83176234	85323	
3919965	85702		471700006038	85088		8071881	85061	89450	83176235	85724	
3919966	85736		471700006040	85088		8073212	85065		83176236	85900	
3919967	85302	89420	471700131256	85065		8075257	85065		83176237	85916	
3919968	85736		471700131258	85081		8075287	85065		83176238	85918	
3919970	85701		471700131920	85933	89454	8077874	85047	89435	83176239	85933	
3919972	85320	89429	471700131921	85933	89454	8077874-P01	85047	89435	83176240	646155	
3919973	85956		47902-24	83137		8078195	85061	89450	85104186	85006	
3919974	85712		494-660	83219		8083872	85978		85104221	85066	89448
3919975	85700		4940640	83216		8086053	85047	89435	85106580	85918	89449
3919976	85033	89427	4975479	83400		8086651	85066	89448	85107238	85976	
3919977	85033	89427	4975480	83400		8169859	85047	89435	85134402	85061	89450
3919978	85702		4975549	83216		8174749	85906	89407	85137234	83125	
3919979	85702		530596	85308	89422	83176191	83019		85137420	85000	89436
3919980	85702		5322338	83214		83176192	83041		90045605	85109	
3919981	85701		5513989	83216		83176193	83045		RC SA3041	83041	
3919982	85703		5531435	85307		83176194	83048		RC SA3045	83045	
3919983	85704		5531436	85307		83176195	83103		RC SA3048	83048	
3919984	85700		5531437	85307		83176196	83110		RC SA3103	83103	
3919985	85723		5534430	85303	89422	83176197	83111		RC SA3111	83111	
3919987	85706		5534447	85303	89422	83176198	83112		RC SA3112	83112	
3919988	85311	89424	5549899	83207	89407	83176199	83123		RC SA3124	83124	
3919989	85709		5549925	85304		83176200	83124		RC SA3125	83125	
3919990	85003	89411	5554959	83401		83176201	83125		RC SA3127	83127	
3919991	85708		57241-3	83112		83176202	83126		RC SA3128	83128	89436
3919992	85733		60657-007	85072		83176203	83127		RC SA3136	83136	
3919993	85712		60675-001	85978		83176204	83128		RC SA3148	83148	
3919994	85310	89423	629398	85307		83176205	83136		RC SA3203	83203	
3945806		89417	629501	85307		83176206	83148		RC SA3216	83216	
3945807		89416	646220	85734		83176207	83203		RC SA5000	85000	
3945808		89407	64838-001	85933	89454	83176208	83209		RC SA5001	85001	
3945809		89410	64838-002	85933	89454	83176209	83215		RC SA5003	85003	
3945810		89420	64838-003	85933	89454	83176210	83216		RC SA5005	85005	
3945811		89409	66010-0016	85025		83176211	85000		RC SA5047	85047	
3945812		89423	662211401	83215		83176212	85001		RC SA5052	85052	
3945813		89428	665410	85027	89418	83176213	85003		RC SA5061	85061	
3945814		89424	665539	85026	89417	83176214	85005		RC SA5062	85062	
3945815		89406	665607	85047	89435	83176215	85023		RC SA5066	85066	
3945816		89430	665623	85046	89434	83176216	85026		RC SA5067	85067	
3945817		89422	665739	85047	89435	83176217	85033		RC SA5070	85070	
3945818		89415	668302	83216		83176218	85036		RC SA5310	85310	
3945819		89411	676081	83401		83176219	85045		RC SA5320	85320	
3945820		89413	676082	83401		83176220	85046		RC SA5724	85724	
3945821		89419	6771501	85040		83176221	85047		RC SA5900	85900	
3946210	83103		6772218	85040		83176222	85052		RC SA5918	85918	
3946217	83125		6775411	85040		83176223	85061		RC SA5933	85933	

Important Note: Competitive Interchanges are to be used for stocking purposes only. Where multiple crosses are identified, please reference the applications section of this catalog. / **Remarque importante:** Les interchanges concurrentiels ne s'utilisent qu'aux fins de stocks. Dans le cas de références multiples, consulter la section des applications du catalogue. / **Nota importante:** Dans le cas de références multiples, consulter la section des applications du catalogue. / **Nota importante:** Se pueden usar intercambios competitivos para propósitos de almacenamiento solamente. Cuando se identifican intercambios múltiples, consulte la sección de aplicaciones de este catálogo.

COMPETITIVE & O.E.M. INTERCHANGE LIST

Lista de Intercambios contra Competidores y Equipo Original.

Liste d'interchange de produits compétitifs & d'équipement original (OEM)

VOLVO... cont'd

O.E.M #	Gabriel	Upgrade	O.E.M #	Gabriel	Upgrade	O.E.M #	Gabriel	Upgrade	O.E.M #	Gabriel	Upgrade
RC SA6155	646155		SA3126	83126		SA5036	85036		SA5310	85310	
SA3019	83019		SA3127	83127		SA5045	85045		SA5311	85311	
SA3041	83041		SA3128	83128		SA5046	85046		SA5320	85320	
SA3045	83045		SA3136	83136		SA5047	85047		SA5321	85321	
SA3048	83048		SA3148	83148		SA5052	85052		SA5323	85323	
SA3103	83103		SA5000	85000		SA5061	85061		SA5724	85724	
SA3110	83110		SA5001	85001		SA5062	85062		SA5900	85900	
SA3111	83111		SA5003	85003		SA5066	85066		SA5916	85916	
SA3112	83112		SA5005	85005		SA5067	85067		SA5918	85918	
SA3123	83123		SA5023	85023		SA5069	85069		SA5933	85933	
SA3124	83124		SA5026	85026		SA5070	85070		SA6155	646155	
SA3125	83125		SA5033	85033		SA5303	85303		SDA471700131258	85081	

VOLVO CAB SHOCKS

O.E.M #	Gabriel	Upgrade	O.E.M #	Gabriel	Upgrade	O.E.M #	Gabriel	Upgrade	O.E.M #	Gabriel	Upgrade
1201-0012	83023		20721254	83048		22662230	TBR -		8078546	83028	
1202-0012	83023		20874147	83050			83905		8078547	83029	
1202-0022	83046		21368411	TBR -		22662235	TBR -		8162662	83004	
1202-0032	83016			83905			83905		8168617	83030	
20496215	83048		21368413	83048		22662237	TBR -		85107095	83009	
20496217	83029		21391412	83048			83905				
20704334	83048		22662125	83048		3945842	83009				
			22662224	83048		635869	83004				
						66010-0007	83004				
						66010-0008	83004				

WABASH NATIONAL

O.E.M #	Gabriel	Upgrade	O.E.M #	Gabriel	Upgrade	O.E.M #	Gabriel	Upgrade	O.E.M #	Gabriel	Upgrade
202447	85919		FRUUCE1295-901	85300	89419	HENS-24088	83128	89436	NEW900-44-868	85045	
203447	85919		FRUUCE2983-1	85322		HENS-24088	85000	89436	NEW900-44-978	85059	
DANSR1VJ100	85078		FRUUCF8339-1	85321		NEW900-44-089	83124	89407	NEW900-44-979	83113	
FLL83203-071	83203	89436	HENS-20001	83128	89436	NEW900-44-162	83128	89436	NEW900-45-040	83130	
FLL83207-071	83207	89407	HENS-20002	85000	89436	NEW900-44-625	83125		NEW900-45-054	85051	
FLL85000-071	85000	89436	HENS-20126	85323	89436	NEW900-44-626	83126	89430	NEW900-45-298	83128	
FLL85030-071	85030	89440	HENS-21292	85052		NEW900-44-642	83127		NEW900-45-299	85000	89436
FRUUCE1295-1	85300	89419	HENS-23566	85000	89436	NEW900-44-794	83127				

WATSON & CHALIN MFG. INC.

O.E.M #	Gabriel	Upgrade	O.E.M #	Gabriel	Upgrade	O.E.M #	Gabriel	Upgrade	O.E.M #	Gabriel	Upgrade
10147	83203	89436	17186-01	85323	89436	19250	85382		680714	85934	
10147HD	85000	89436	17218	85029		19603	85939		727603	83203	89436
10148	83204		17297	85064		3946219	83400		727604	83204	
10634	G63357		17300	85052		665724	85000	89436	A-20345	85345	
11418	646155		17306	85938		665727	85005	89430	B-23649	85064	
11604	83125		17317	85344		665728	85060		B-23650	85052	
11724	83123	89405	17382	85014		665769	85052		B-23651	85045	
12128	85005	89430	17430	85321		665770	85064		B-23743	85938	
17069	632147		17474	85009		665862	85000	89436			
17079	85300	89419	19036	85934		680547	85323	89436			
17186	85323	89436	19249	85939		680584	85938				

WESTERN STAR

O.E.M #	Gabriel	Upgrade	O.E.M #	Gabriel	Upgrade	O.E.M #	Gabriel	Upgrade	O.E.M #	Gabriel	Upgrade
02-7005976	83400		35901-3406	85305		37390-4401	85053	89442	57905-1	85976	
02-7005977	83400		35901-3409	85304		37390-4402	85053	89442	57905-2	85006	
04-9041375	85315		35901-3410	85307		37390-4403	85053	89442	58913-003	85932	89453
10-13809-000	85958		35901-3413	85006		471700004423	85109		58913-012	85932	89453
1011839	83216		35901-3420	85303	89422	471700006269	85932	89453	60675-002	85979	
16-15770-000	85956		35901-4403	85060		471700131331	85932	89453	615016	83401	
16-18706-000	85331		37301-3401	85053	89442	47902-13	83122	89406	665682	85053	89442
16-18708-000	85724	89443	37301-3404	85053	89442	47902-24	83137				
28R010	83216		37301-3405	85053	89442	47902-8	83122	89406			
35066-4413	83122	89406	37301-3409	85053	89442	57241-1	83111				
35901-0001	83209	89414	37301-3412	85053	89442	57252	85308	89422			

Important Note: Competitive Interchanges are to be used for stocking purposes only. Where multiple crosses are identified, please reference the applications section of this catalog. / **Remarque importante:** Les interchanges concurrentiels ne s'utilisent qu'aux fins de stocks. Dans le cas de références multiples, consulter la section des applications du catalogue. / **Nota importante:** Dans le cas de références multiples, consulter la section des applications du catalogue. / **Nota importante:** Se pueden usar intercambios competitivos para propósitos de almacenamiento solamente. Cuando se identifican intercambios múltiples, consulte la sección de aplicaciones de este catálogo.

COMPETITIVE & O.E.M. INTERCHANGE LIST
Lista de Intercambios contra Competidores y Equipo Original.
Liste d'interchange de produits compétitifs & d'équipement original (OEM)

WESTERN STAR... cont'd

O.E.M #	Gabriel	Upgrade	O.E.M #	Gabriel	Upgrade	O.E.M #	Gabriel	Upgrade	O.E.M #	Gabriel	Upgrade
676081	83401		90044907	83635		CP-5222	85315				
676082	83401		90045099	85906	89407	SDA471700003920	85958				
90044025	83209	89414	90045605	85109		SDA481700125969	85956				

WESTERN STAR CAB SHOCKS

O.E.M #	Gabriel	Upgrade	O.E.M #	Gabriel	Upgrade	O.E.M #	Gabriel	Upgrade	O.E.M #	Gabriel	Upgrade
1201-0012	83023		18-60772-000	83026		66010-3403	83022		725470	83010	
1201-0022	83046		18-60773-000	83027		66010-3404	83022		81-4903003500	83026	
1202-0012	83023		617547	83022		66010-3405	83026		814903003501	83027	
1202-0022	83046		654846	83027		66010-3406	83027		GBL 654916	83026	
1202-0032	83016		66010-3402	83022		66010-3407	83065				

WESTERN UNIT ``STABILAIRE" SUSPENSION

O.E.M #	Gabriel	Upgrade	O.E.M #	Gabriel	Upgrade	O.E.M #	Gabriel	Upgrade	O.E.M #	Gabriel	Upgrade
101030	85307		4939967	85308	89422	80600	85300	89419			
101364	85305		80370	85304							

WESTPORT AXLE CORP

O.E.M #	Gabriel	Upgrade	O.E.M #	Gabriel	Upgrade	O.E.M #	Gabriel	Upgrade	O.E.M #	Gabriel	Upgrade
143699-0185	646177		646124	646177							

WINNEBAGO

O.E.M #	Gabriel	Upgrade	O.E.M #	Gabriel	Upgrade	O.E.M #	Gabriel	Upgrade	O.E.M #	Gabriel	Upgrade
141700131809	85029		16-16736-000	85029		16-16873-000	85029		16-18103-000	85900	
141700131810	83160		16-16737-000	83160		16-16874-000	83160		481700000493	85900	

WORKHORSE

O.E.M #	Gabriel	Upgrade	O.E.M #	Gabriel	Upgrade	O.E.M #	Gabriel	Upgrade	O.E.M #	Gabriel	Upgrade
24-153249	85125		659223	G63866		F4-BE5-B492-HO	85125		W0006254	85125	
24-153256	85124		680672	85919		F4-BE5-F324-HO	85125		W0007363	83171	
24-186537	85126		7805-X-1012	85919		F4-BE5-F325-HO	85124		W0007365	G63866	
24-186629	85125		F4-BE5-A011-HO	85126		W0005662	85125		W8007000	83171	
659222	83171		F4-BE5-A832-MO	85125		W0005663	85124				

Important Note: Competitive Interchanges are to be used for stocking purposes only. Where multiple crosses are identified, please reference the applications section of this catalog. / **Remarque importante:** Les interchanges concurrentiels ne s'utilisent qu'aux fins de stocks. Dans le cas de références multiples, consulter la section des applications du catalogue. / **Nota importante:** Dans le cas de références multiples, consulter la section des applications du catalogue. / **Nota importante:** Se pueden usar intercambios competitivos para propósitos de almacenamiento solamente. Cuando se identifican intercambios múltiples, consulte la sección de aplicaciones de este catálogo.

HOW TO DETERMINE THE CORRECT SHOCK FOR YOUR TRUCK

CÓMO ESCOGER EL MEJOR AMORTIGUADOR PARA SU CAMIÓN

COMMENT CHOISIR LE BON AMORTISSEUR POUR VOTRE CAMION

Part Number: The catalog number for the individual shock absorber.

Extended Length*: The length of the shock absorber when it is fully extended. See "How to Measure" instructions.

Collapsed Length*: The length of the shock absorber when it is fully collapsed. See "How to Measure" instructions

Stroke: This is the approximate length of the stroke of the individual shock absorber being described.

Mounting Codes: Indicates the type of mounting ends for the upper and lower end of each shock absorber.

They are listed as follows:

- Stud type mounts ("S" & "DS")
- Eye ring and bushing mounts ("EB")
- Eye ring and bushing with sleeve mounts ("ES")
- Eye ring and bushing with bar pin mounts ("BP")
- Special mounting codes ("SP")

Número de parte: El número de catálogo para el amortiguador individual.

Longitud extendida*: La longitud del amortiguador cuando está totalmente extendido. Consulte las instrucciones "Cómo medir".

Longitud colapsada*: La longitud del amortiguador cuando está totalmente colapsado. Consulte las instrucciones "Cómo medir".

Carrera: Esta es la longitud aproximada de la carrera del amortiguador individual que se está describiendo.

Códigos de montura: Indica el tipo de extremos de montura para el extremo superior e inferior de cada amortiguador.

Se enumeran de la siguiente manera:

- Monturas tipo perno ("S" y "DS")
- Monturas de anillo y casquillo ("EB")
- Monturas de anillo y casquillo con funda ("ES")
- Monturas de anillo y casquillo con pasador de barra ("BP")
- Códigos especiales de montura ("SP")

Numéro de pièce : Le numéro de catalogue pour l'amortisseur individuel.

Longueur en extension*: La longueur de l'amortisseur lorsqu'il est en extension complète. Voir les instructions « Comment mesurer ».

Longueur plié*: La longueur de l'amortisseur lorsqu'il est complètement plié. Voir les instructions « Comment mesurer ».

Course: Ceci est la longueur approximative de la course de l'amortisseur individuel décrit ici.

Codes de fixation: Indique le type d'extrémité de fixation pour l'extrémité supérieure et inférieure de chaque amortisseur.

Ils sont classés comme suit :

- Fixations à goujons (« S » et « DS »)
- Fixations à œillet et à douille (« EB »)
- Fixations à œillet et douille de glissement (« ES »)
- Fixations à œillet et à douille avec broche (« BP »)
- Codes de fixations spéciales (« SP »)

CONVERSION CHART | TABLA DE CONVERSIÓN | TABLEAU DE CONVERSION

Fraction Fracción	Decimal Décimal	Metric Métrico Métrique	Fraction Fracción	Decimal Décimal	Metric Métrico Métrique
(INCHES)	(INCHES)	(MM)	(INCHES)	(INCHES)	(MM)
1/64	0.016	0.397	33/64	0.516	13.097
1/32	0.031	0.794	17/32	0.531	13.494
3/64	0.047	1.191	35/64	0.547	13.891
1/16	0.063	1.588	9/16	0.563	14.288
5/64	0.078	1.984	37/64	0.578	14.684
3/32	0.094	2.381	19/32	0.594	15.081
7/64	0.109	2.778	39/64	0.609	15.478
1/8	0.125	3.175	5/8	0.625	15.875
9/64	0.141	3.572	41/64	0.641	16.272
5/32	0.156	3.969	21/32	0.656	16.669
11/64	0.172	4.366	43/64	0.672	17.066
3/16	0.188	4.763	11/16	0.688	17.463
13/64	0.203	5.159	45/64	0.703	17.859
7/32	0.219	5.556	23/32	0.719	18.256
15/64	0.234	5.953	47/64	0.734	18.653
1/4	0.250	6.350	3/4	0.750	19.050
17/64	0.266	6.747	49/64	0.766	19.447
9/32	0.281	7.144	25/32	0.781	19.844
19/64	0.297	7.541	51/64	0.797	20.241
5/16	0.313	7.938	13/16	0.813	20.638
21/64	0.328	8.334	53/64	0.828	21.034
11/32	0.344	8.731	27/32	0.844	21.431
23/64	0.359	9.128	55/64	0.859	21.828
3/8	0.375	9.525	7/8	0.875	22.225
25/64	0.391	9.922	57/64	0.891	22.622
13/32	0.406	10.319	29/32	0.906	23.019
27/64	0.422	10.716	59/64	0.922	23.416
7/16	0.438	11.113	15/16	0.938	23.813
29/64	0.453	11.509	61/64	0.953	24.209
15/32	0.469	11.906	31/32	0.969	24.606
31/64	0.484	12.303	63/64	0.984	25.003
1/2	0.500	12.700	1	1.000	25.400

METRIC CONVERSION CHART | TABLA DE CONVERSIÓN MÉTRICA | TABLEAU DE CONVERSION

(MM)	(INCHES)	(MM)	(INCHES)	(MM)	(INCHES)
1	0.03937	10	0.39370	19	0.74803
2	0.07874	11	0.43307	20	0.78740
3	0.11811	12	0.47244	21	0.82677
4	0.15748	13	0.51181	22	0.86614
5	0.19685	14	0.55118	23	0.90551
6	0.23622	15	0.59055	24	0.94488
7	0.27559	16	0.62992	25	0.98425
8	0.31496	17	0.66929		
9	0.35433	18	0.70866		

HOW TO DETERMINE THE CORRECT SHOCK FOR YOUR TRUCK

CÓMO ESCOGER EL MEJOR AMORTIGUADOR PARA SU CAMIÓN COMMENT CHOISIR LE BON AMORTISSEUR POUR VOTRE CAMION

- STEP 2:** Identify the mounting style. Measure fully extended and fully collapsed lengths at the locations indicated for mounting style.
- 2º PASO:** Identifique el tipo de montaje. Mida la longitud totalmente extendida y totalmente comprimida, en los puntos indicados para cada tipo de montaje.
- 2È ÉTAPE:** Identifiez la méthode de fixation. Mesurez la longueur en pleine extension et en pleine compression, aux endroits indiqués pour la méthode de fixation.

HOW TO MEASURE EXTENDED & COLLAPSED LENGTHS OF SHOCK ABSORBERS COMO MEDIR LAS LONGITUDES EXTENDIDA Y COMPRIMIDA DE LOS AMORTIGUADORES COMMENT MESURER LES LONGUEURS ALLONGÉ ET COMPRIMÉ DES AMORTISSEURS

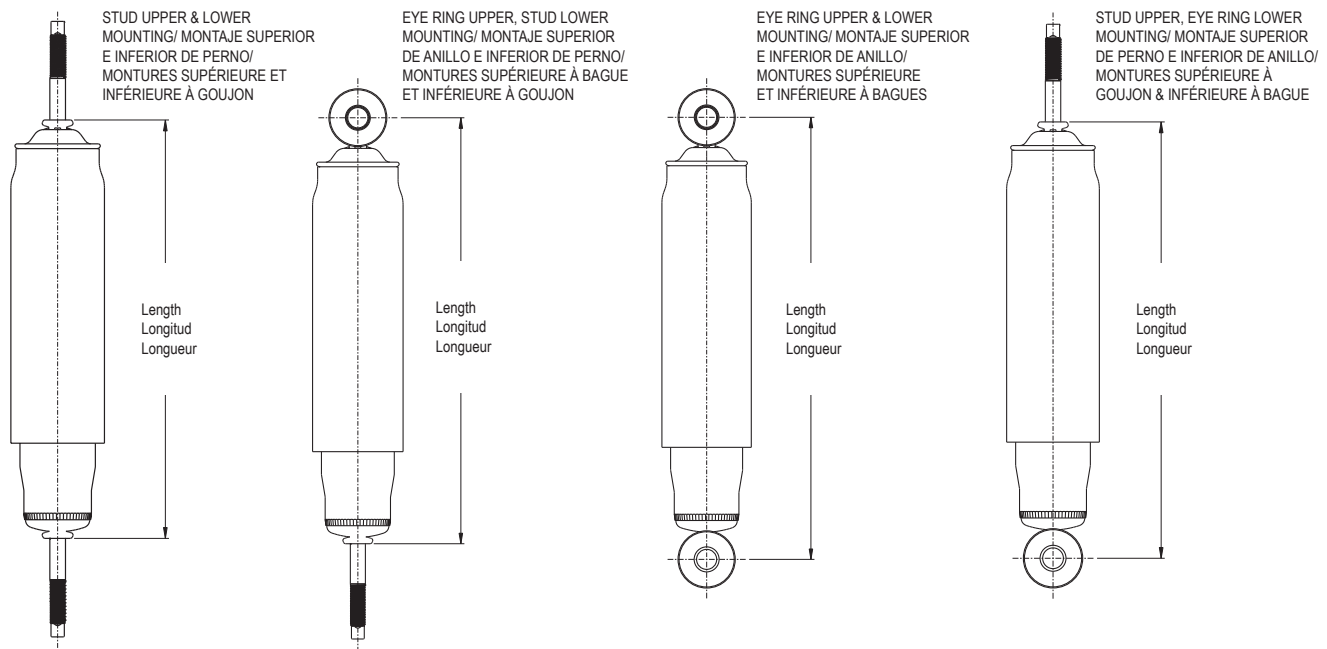

INSTRUCTIONS:

- Using the proper measuring points as shown above find the nearest replacement shock absorber from the listing by increments of extended length.
- Identify the proper mounting from the mounting codes and match these requirements by carefully measuring the mounting dimensions (top and bottom) of the shock absorber to be replaced.
- Carefully take note of the following requirements:
 - Dust tubes** - This requirement should be noted in comparison with the shock absorber to be replaced. Shock absorber environment in its application makes this requirement necessary for piston rod protection and extended shock absorber life.
 - Recoil Cutoff and Compression Bumper** - Carefully note these specifications - deviation of length requirements should not exceed $\pm 1/4$ ". These shock absorber designs are footnoted for easy identification.

Note: Shock absorbers used for installations other than those recommended in our catalog are **not subject to warranty**.

INSTRUCCIONES:

- Usando los puntos de medida adecuados como mencionado, encuentre el amortiguador más cercano en la lista por incrementos de la longitud extendida.
- Identifique la montaje adecuado por medio de los códigos de fijación y compare estas especificaciones, midiendo cuidadosamente las dimensiones de la montaje (superior e inferior) del amortiguador por reemplazar.
- Note cuidadosamente las exigencias siguientes:
 - Polvera** - Este componente debe estar presente en el amortiguador por reemplazar. El ambiente de trabajo del amortiguador hacen a la polvera necesaria para proteger la barra del pistón y extender la vida del producto.
 - Tope de retorno y tope de compresión** - Note cuidadosamente las especificaciones siguientes : las exigencias de longitud no deben de ser excedidas $\pm 1/4$ ". Estos diseños de amortiguadores están marcados para facilitar su identificación.

Nota: Los amortiguadores usados para instalaciones otras que las recomendadas en nuestro catálogo **no son garantizados**.

INSTRUCTIONS:

- En utilisant les points de mesure appropriés comme indiqués ci-dessus, trouvez l'amortisseur de rechange le plus près de cette mesure d'après la longueur allongée.
- Repérez les montures appropriées sur les codes des montures et faites correspondre ces exigences en mesurant attentivement les dimensions des montures (haut et bas) de l'amortisseur à replacer.
- Avec soin, prenez note des exigences suivantes:
 - Tubes pare-poussière** - Cette exigence devrait être notée en comparaison de l'amortisseur à remplacer. Le milieu de service rend cette exigence nécessaire pour la protection de la tige de piston et une meilleure longévité de l'amortisseur.
 - Arrêt de retour et butée de compression** - Notez avec soin ces spécifications. La déviation par rapport aux exigences de longueurs ne doit pas dépasser $\pm 1/4$ po. Ces modèles d'amortisseurs portent une note pour une identification facile.

Note: Les amortisseurs utilisés pour des installations autres que celles recommandées dans notre catalogue **ne sont pas couverts par la garantie**.

HOW TO DETERMINE THE CORRECT SHOCK FOR YOUR TRUCK

CÓMO ESCOGER EL MEJOR AMORTIGUADOR PARA SU CAMIÓN COMMENT CHOISIR LE BON AMORTISSEUR POUR VOTRE CAMION

STEP 1: Measure the diameter of the dust tube and cylinder to determine the series.

1^{ER} PASO: Mida el diámetro del tubo de polvo y del cilindro para determinar la serie.

1^{RE} ÉTAPE: Mesurez le diamètre du tube de poussière et du cylindre pour déterminer la série.

EXTERNAL DIMENSIONS DIMENSIONES EXTERNAS DIMENSIONS EXTÉRIEURES

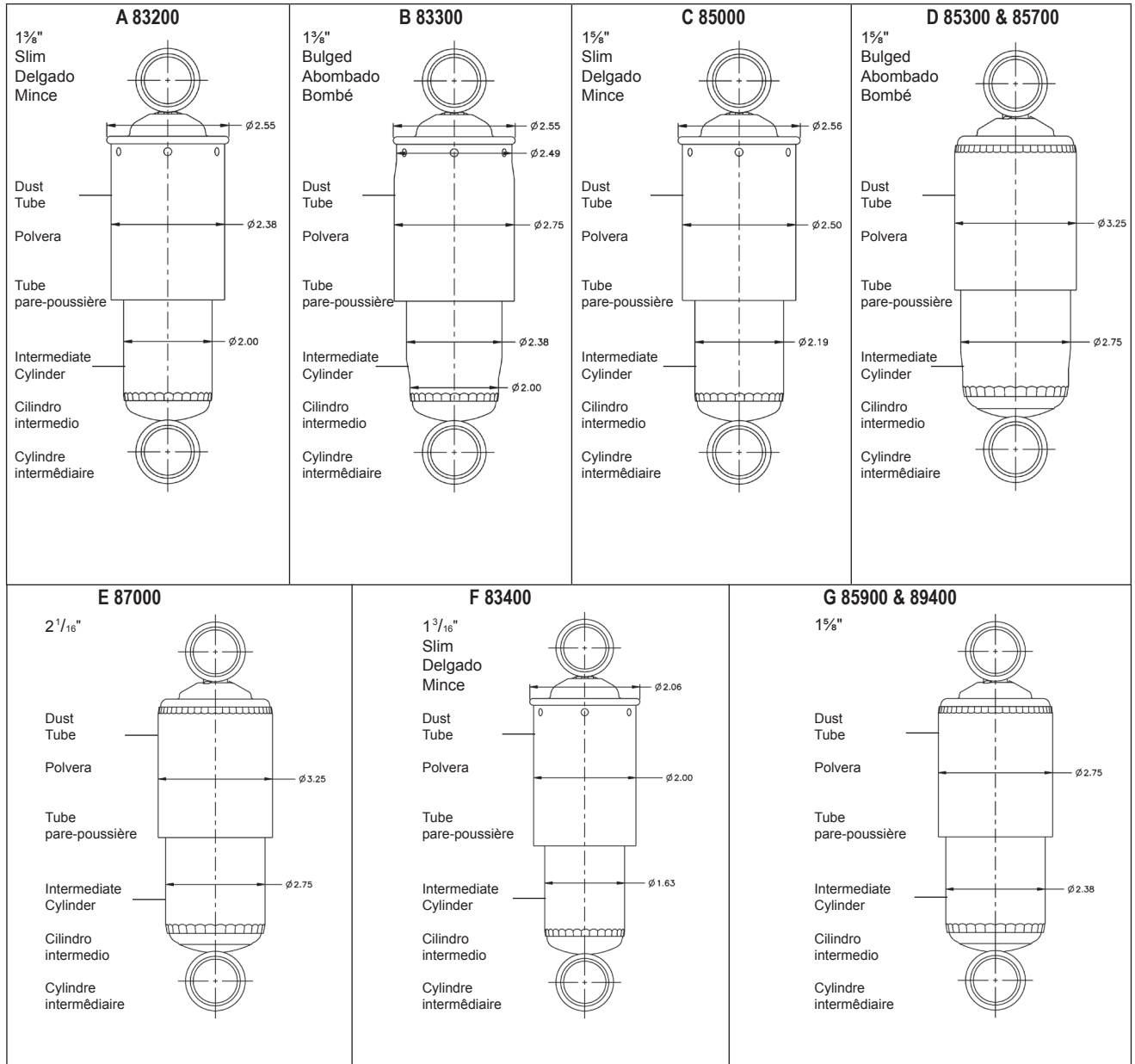

HOW TO DETERMINE THE CORRECT SHOCK FOR YOUR TRUCK

CÓMO ESCOGER EL MEJOR AMORTIGUADOR PARA SU CAMIÓN COMMENT CHOISIR LE BON AMORTISSEUR POUR VOTRE CAMION

STEP 3: Measure end mount diameters, widths, and lengths. Refer to the following end mount tables to determine the appropriate or matching mounting code.

3ER PASO: Mida las dimensiones del tubo, así como el diámetro, la anchura y la longitud de las fijaciones. Consulte las tablas siguientes de conteras para determinar el código de montaje apropiado o concorde.

3E ÉTAPE: Mesurez le diamètre, la largeur et la longueur des bagues. Consultez les tableaux d'embouts suivants afin d'établir le code de montage approprié ou concordant.

MOUNTING CODE "EB" EYE RING AND BUSHING CODIGO DE FIJACION «EB» ANILLO Y BUJE CODE DE MONTURE "EB" À BAGUE ET MANCHON

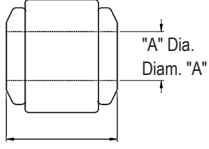
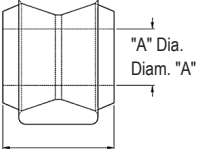
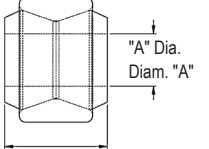
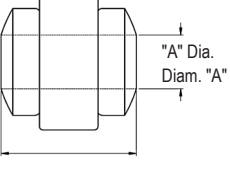
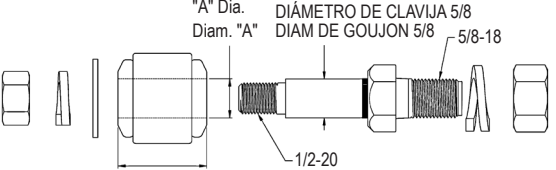
<p>EB1</p>  <p>"A" Dia. Diam. "A"</p> <p>FREE LENGTH "B" COMP LENGTH "C" LONGITUD LIBRE "B" LONGITUD COMPRIMIDA "C" LONGUEUR NON COMP "B" LONGUEUR COMP "C"</p>	<p>EB2</p>  <p>"A" Dia. Diam. "A"</p> <p>FREE LENGTH "B" COMP LENGTH "C" LONGITUD LIBRE "B" LONGITUD COMPRIMIDA "C" LONGUEUR NON COMP "B" LONGUEUR COMP "C"</p>	<p>EB3</p>  <p>"A" Dia. Diam. "A"</p> <p>FREE LENGTH "B" COMP LENGTH "C" LONGITUD LIBRE "B" LONGITUD COMPRIMIDA "C" LONGUEUR NON COMP "B" LONGUEUR COMP "C"</p>
<p>EB4</p>  <p>"A" Dia. Diam. "A"</p> <p>FREE LENGTH "B" COMP LENGTH "C" LONGITUD LIBRE "B" LONGITUD COMPRIMIDA "C" LONGUEUR NON COMP "B" LONGUEUR COMP "C"</p>	<p>EB7</p>  <p>"A" Dia. Diam. "A"</p> <p>5/8 PIN DIA DIÁMETRO DE CLAVIJA 5/8 DIAM DE GOUJON 5/8</p> <p>1/2-20</p> <p>5/8-18</p> <p>FREE LENGTH "B" COMP LENGTH "C" LONGITUD LIBRE "B" LONGITUD COMPRIMIDA "C" LONGUEUR NON COMP "B" LONGUEUR COMP "C"</p>	

MOUNTING CODE "EB" EYE RING AND BUSHING CÓDIGO DE MONTAJE «EB» ANILLO Y BUJE CODE DE MONTURE "EB" A BAGUE ET MANCHON

Mounting Code Código de montaje Code de monture	"A" Dia. Diámetro "A" Diam. "A"	B Free Length Longitud libre Long. non comp.	C Comp. Length Longitud comprimida Long. comp.	Vehicle Mounting Pin Dia. Diámetro de clavija de montaje del vehículo Diam. du goujon de montage du véhicule
EB1	5/8	1.44	1.31	5/8
EB2	3/4	1.75	1.50	3/4
EB3	1.00	1.91	1.75	1.00
EB4	11/16	1.72	1.55	11/16
EB7	5/8	1.44	1.31	Mounting pin furnished with shock absorber for 5/8" dia. vehicle mounting hole. Perno proveído con el amortiguador para orificio de montaje de 5/8" de diámetro. Goujon de montage fourni avec l'amortisseur pour trou de montage de 5/8 po de diam. sur véhicule.

HOW TO DETERMINE THE CORRECT SHOCK FOR YOUR TRUCK

CÓMO ESCOGER EL MEJOR AMORTIGUADOR PARA SU CAMIÓN

COMMENT CHOISIR LE BON AMORTISSEUR POUR VOTRE CAMION

MOUNTING CODE "ES" & "CB" EYE RING AND BUSHING WITH STEEL SLEEVE

CÓDIGO DE MONTAJE «ES» Y «CB» ANILLO Y BUJE CON CAMISA DE ACERO

CODE DE MONTURE "ES" & "CB" BAGUE ET MANCHON AVEC COLLET EN ACIER

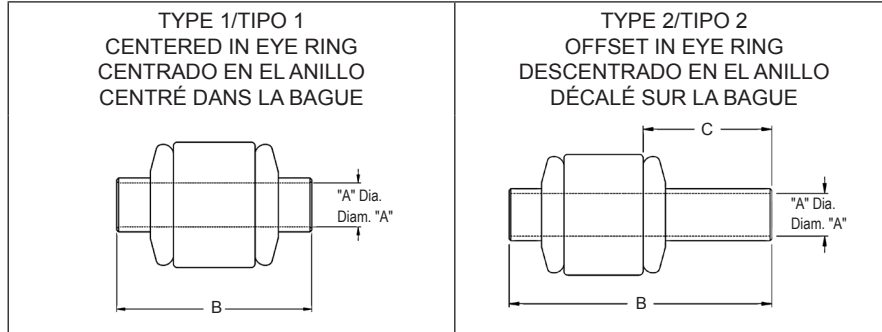

MOUNTING CODE	TYPE	DIMENSION		
		A	B	C
ES2	1	10MM	1.42	--
ES3	1	10MM	1.56	--
ES8	1	7/16	1.25	--
ES10	1	7/16	1.38	--
ES19	1	12MM	1.88	--
ES22	1	1/2	1.25	--
ES24	1	1/2	1.38	--
ES25	1	1/2	1.50	--
ES26	1	1/2	1.56	--
ES27	1	1/2	1.62	--
ES34	1	9/16	1.66	--
ES35	1	5/8	1.38	--
ES36	1	3/4	1.75	--
ES53	1	10MM	1.38	--
ES69	1	12MM	1.58	--
ES82	1	31/64	1.53	--
ES83	1	12MM	1.48	--
ES86	1	14MM	2.44	--
ES90	1	5/8	2.00	--
ES91	1	1/2	2.10	--
ES115	1	10MM	2.02	--
ES120	1	3/4	2.76	--
ES121	1	3/4	2.06	--
ES128	1	1/2	1.66	--
ES136	1	5/8	1.75	--
ES149	1	1/2	2.36	--
ES150	1	3/4	2.24	--
ES153	1	14MM	1.55	--
ES158	1	3/4	3.80	--
ES159	2	3/4	3.21	1.03
ES160	1	1.00	2.01	--

MOUNTING CODE	TYPE	DIMENSION		
		A	B	C
ES161	1	16MM	3.95	--
ES162	1	16MM	2.60	--
ES163	1	7/16	2.50	--
ES164	1	1/2	2.26	--
ES165	1	1/2	1.75	--
ES166	1	5/8	2.97	--
ES167	1	14MM	2.31	--
ES168	1	14MM	2.62	--
ES169	1	14MM	1.91	--
ES171	1	1/2	1.88	--
ES172	1	1/2	2.72	--
ES173	1	7/8	2.28	--
ES174	1	5/8	3.25	--
ES175	1	16MM	1.96	--
ES176	1	16MM	3.72	--
ES177	1	16MM	3.55	--
ES178	1	3/4	1.96	--
ES179	1	20MM	1.75	--
ES181	1	7/16	1.98	--
ES182	1	20MM	1.96	--
ES183	1	20MM	3.80	--
ES184	1	20MM	2.44	--
ES185	1	12MM	2.44	--
ES187	1	1.00	1.75	--
ES188	1	16MM	1.81	--
ES190	1	22MM	1.75	--
ES193	1	24MM	2.28	--
ES194	1	7/8	2.28	--
ES195	1	20MM	4.07	--
ES206	1	1/2	3.13	--

HOW TO DETERMINE THE CORRECT SHOCK FOR YOUR TRUCK

CÓMO ESCOGER EL MEJOR AMORTIGUADOR PARA SU CAMIÓN
COMMENT CHOISIR LE BON AMORTISSEUR POUR VOTRE CAMION

MOUNTING CODE "BP" EYE RING AND BUSHING WITH BAR PIN

CÓDIGO DE MONTAJE «BP» ANILLO Y BUJE CON CLAVIJA TIPO BARRA

CODE DE MONTURE "BP" BAGUE ET MANCHON AVEC GOUPILLE

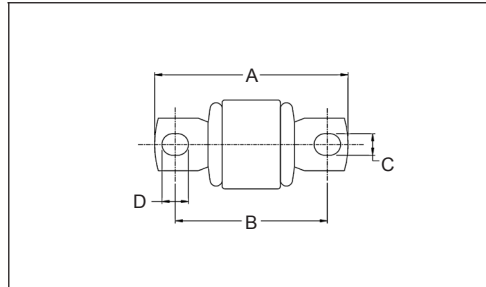

MOUNTING CODE	A	B	C	D
BP7	3.13	2.50	0.35	0.42
BP8	3.50	2.87	0.35	0.42
BP27	4.00	2.95	0.52	0.50
BP33	4.44	3.62	0.39	0.47
BP35	3.53	2.73	0.38	0.38

HOW TO DETERMINE THE CORRECT SHOCK FOR YOUR TRUCK

CÓMO ESCOGER EL MEJOR AMORTIGUADOR PARA SU CAMIÓN

COMMENT CHOISIR LE BON AMORTISSEUR POUR VOTRE CAMION

MOUNTING CODES "S" STUD MOUNT

CÓDIGOS DE MONTAJE «S» MONTAJES DE DOBLE PERNO

CODES DE MONTURE "S" À GOUJON

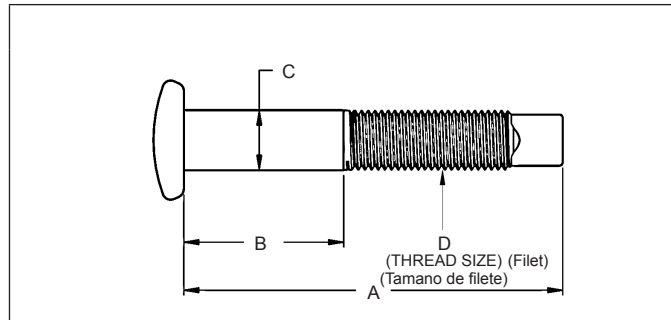

MOUNTING CODE	A	B	C	D
S1	2.37	1.00	3/8	3/8-24
S4	1.85	1.00	3/8	3/8-24
S6	2.47	1.47	7/16	3/8-24
S10	2.37	1.33	7/16	3/8-24
S12	2.37	1.15	7/16	3/8-24
S16	2.95	1.45	16MM	16MM
S21	3.28	1.75	5/8	5/8-18
S28	2.44	1.37	12MM	M10x1
S36	2.49	1.33	7/16	3/8-24
S38	2.75	1.70	14MM	12MM
S40	2.52	1.33	7/16	3/8-24
S42	3.50	2.00	5/8	5/8-18
S43	2.75	1.25	5/8	5/8-18

HOW TO DETERMINE THE CORRECT SHOCK FOR YOUR TRUCK

CÓMO ESCOGER EL MEJOR AMORTIGUADOR PARA SU CAMIÓN

COMMENT CHOISIR LE BON AMORTISSEUR POUR VOTRE CAMION

EXPLANATION OF COLUMN HEADINGS

EXPLICACIÓN DE LOS TÍTULOS DE LAS COLUMNAS

EXPLICATION DES EN-TÊTES DE COLONNES

SHOCK ABSORBER PART NUMBER: The catalog number for the individual shock absorber.	Número de parte del amortiguador: El número de catálogo para el amortiguador individual.	Numéro de pièce de l'amortisseur: Le numéro de catalogue pour l'amortisseur individuel.
EXTENDED LENGTH:* The length of the shock absorber when it is fully extended. See "How to Measure" instructions.	Longitud extendida :* La longitud del amortiguador cuando está totalmente extendido. Ver instrucciones «Cómo medir».	Longueur étirée:* La longueur de l'amortisseur entièrement étiré. Voir "Comment mesurer".
COLLAPSED LENGTH:* The length of the shock absorber when it is fully compressed. See "How to Measure" instructions.	Longitud comprimida :* La longitud del amortiguador cuando está totalmente comprimido. Ver instrucciones «Cómo medir».	Longueur comprimée:* La longueur de l'amortisseur entièrement comprimé. Voir "Comment mesurer".
STROKE: This is the approximate length of the stroke of the individual shock absorber being described.	Carrera : Es la longitud aproximada del recorrido del amortiguador descrito.	Course: C'est la longueur approximative de la course de l'amortisseur individuel décrit.
MOUNTING CODES: Indicates the type of mounting ends for the upper and lower end of each shock absorber. They are listed as follows: Stud Type Mounts ("S" & "DS") Eye Ring and Bushing Mounts ("EB") Eye Ring and Bushing with Sleeve Mounts ("ES") Eye Ring and Bushing with Bar Pin Mounts ("BP") Special Mounting Codes ("SP")	Códigos de montaje : Indica el tipo de montantes de montaje superior e inferior para cada amortiguador. Se enlistan como sigue : Montajes tipo perno («S» y «DS») Montajes anillo y buje («EB») Montajes anillo y buje con camisa («ES») Montajes anillo y buje con clavija («BP») Códigos de montajes especiales («SP»)	Codes de montage: Indique le type de montures supérieure et inférieure de chaque amortisseur. Ils sont énumérés comme suit: Montures de type goujon ("S" et "DS") Montures à bague et manchon ("EB") Montures à bague et manchon avec collet ("ES") Montures à bague et manchon avec goupille ("BP") Codes de montures spéciales ("SP")
DUST TUBE: Indicates whether the shock absorber is supplied with a dust tube.	Polvera: Indica si el amortiguador cuenta un polvera.	Tube pare-poussière: Indique que l'amortisseur est fourni avec un tube pare-poussière.
MOUNTING ACCESSORY PACKAGE NUMBER: The part number of the Mount Accessory Package supplied with the shock absorber.	Número de paquete de accesorios de montaje: El número de parte del paquete de accesorios de montaje proveído con el amortiguador.	Numéro d'emballage d'accessoires de montage: Le numéro de pièce de l'emballage d'accessoires de montage fourni avec l'amortisseur.
*NOTE: All dimensions shown are in inches	*Nota : Todas las dimensiones son en pulgadas	*Note: Toutes les dimensions indiquées sont en pouces

STEP 4: Refer to shock absorber specifications by end mount. Start first by finding the appropriate series. Next, match the extended/collapsed length and find the correct mounting codes. Refer to the far left column of the chart for the correct Gabriel shock absorber part number.

4º PASO: Consulte las especificaciones del amortiguador mostradas al final del catálogo. Encuentre primero la serie adecuada. Luego, compare las longitudes de extensión y de compresión, y encuentre los códigos de montaje correctos. Consulte la columna del extremo izquierdo de la tabla para identificar el número de parte del amortiguador Gabriel correcto.

4E ÉTAPE: Reportez-vous aux spécifications d'amortisseur énoncées à la fin du catalogue. Trouvez d'abord la série appropriée. Comparez ensuite les longueurs d'extension et de compression et trouvez les bons codes de fixation. Reportez-vous à la colonne située à la extrême gauche de tableau pour identifier le bon numéro de pièce pour un amortisseur Gabriel.

SPECIFICATIONS BY END MOUNT
ESPECIFICACIONES POR TIPO DE MONTAJE
SPÉCIFICATIONS PAR FIXATION DES EXTRÉMITÉS

Fleetline	Mounting		Bore	External Diameter Illustration	Lengths			Dust Tube	Recoil Cutoff	Controls*	
	Upper	Lower			Extended	Collapsed	Stroke			Rebound	Compression
83171		ES36	1-3/8"	A	23.98	14.51	9.47	YES	YES	513	146
630811	0	0	1-3/16"		22.45	14.1	8.35	NO	NO		
632147	0	0	1-3/16"		22.45	14.1	8.35	NO	NO		
G63969	412847	ES34	1-3/8"		20.75	13.31	7.44				
83013	BP8	BP8	1-3/16"	2" D/T	7.66	6.63†	1.7	YES	NO	646	480
G63837	BP8	ES83	1-3/8"		28.23	17.95	10.28				
G63679	BP8	ES83	1-3/8"		25	14.97	10.03	YES	NO		
83015	BP8	S1	1-3/8"	A	9.79	7.55	2.24	YES	YES	735	430
83005	BP8	S10	1-3/16"	2" D/T	7.34	5.87	1.47	YES	NO	858	216
83041	BP27	S10	1-3/8"	A	10.51†	8.34†	3.02	YES	YES	486	189
G63607	BP33	ES83	1-3/8"		25.58	15.3	10.28	YES	NO		
83060	EB	BP7	1-3/8"	A	9.76	7.98†	2.25	NO	YES	431	441
83011	EB1	EB1	1-3/8"	A	11.55†	8.43	3.62	YES	YES	738	330
83012	EB1	EB1	1-3/8"	A	11.05†	8.18	3.37	YES	YES	738	330
G63440	EB1	EB1	1-3/8"		26.33	15.55	10.78	NO	NO		
83401	EB1	EB1	1-3/16"	F	24.09	14.26	9.83	YES	NO	341	252
G63419	EB1	EB1	1-3/8"		24.08	14.55	9.53	YES	NO		
G63405	EB1	EB1	1-3/8"		20	12.47	7.53	YES	NO	572	115
83007	EB1	EB1	1-3/8"	A	18.54	11.67	6.87	NO	NO	489	343
G63299	EB1	EB1	1-3/8"		18.08	11.55	6.53	YES	NO	396	109
G63810	EB1	ES83	1-3/8"		31.51	18.48	13.03	YES	NO		
G63808	EB1	ES83	1-3/8"		28.86	17.08	11.78	YES	NO		
G63524	EB1	ES83	1-3/8"		27.08	16.05	11.03	YES	NO		
G63775	EB1	ES83	1-3/8"		27.08	16.05	11.03	YES	NO		
G63461	EB1	ES83	1-3/8"		25.5	15.22	10.28	YES	NO		
G63811	EB1	ES83	1-3/8"		25.5	15.22	10.28	YES	NO		
G63525	EB1	ES83	1-3/8"		23.08	14.05	9.03	YES	NO		
G63773	EB1	ES83	1-3/8"		23.08	14.05	9.03	YES	NO		
G63406	EB1	ES83	1-3/8"		23	13.97	9.03	YES	NO		
G63809	EB1	ES83	1-3/8"		23	13.97	9.03	YES	NO		
G63409	EB1	ES83	1-3/8"		21.58	13.3	8.28	YES	NO		
85063	EB2	EB2	1-5/8"	C	32.01	18.85	13.16	YES	NO	762	174
83107	EB2	EB2	1-3/8"	A	31.6	18.36	13.24	YES	NO	352	77
83314	EB2	EB2	1-3/8"	B	30.64	18.11	12.53	YES	YES	633	143
85024	EB2	EB2	1-5/8"	C	28.74	17.21	11.53	YES	YES	1008	539
83309	EB2	EB2	1-3/8"	B	28.64	17.11	11.53	YES	YES	589	135
89416	EB2	EB2	1-5/8"	G	28.62	17.54	11.08	YES	YES	1155‡	514
89401	EB2	EB2	1-5/8"	G	28.41	17.16	11.25	YES	NO	665‡	194
89446	EB2	EB2	1-5/8"	G	28.36	17.41	10.95	YES	YES	702‡	204
85046	EB2	EB2	1-5/8"	C	27.51	16.6	10.91	YES	YES	1008	539
89434	EB2	EB2	1-5/8"	G	27.12	16.79	10.33	YES	YES	1155‡	514
89403	EB2	EB2	1-5/8"	G	26.86	17.16	9.7	YES	YES	929‡	281

* Damping force, in pounds, to either extend or collapse the shock absorber at an average operating velocity. Fuerza de amortiguación en libras para extender o comprimir el amortiguador a una velocidad de operación promedio. La puissance d'amortissement en poids de l'amortisseur, soit comprimé, doit détendu, à une vitesse de fonctionnement moyenne.

† At bumper contact / Al contacto con el tope de goma / Au contact avec le butoir

‡ For GasSLX Series, forces are at the "Firm" (F) setting. / Para la serie GasSLX, las fuerzas están ajustadas en (F) "Firme". / Pour la série GasSLX, le réglage de la force est sur «Firme» (F).

SPECIFICATIONS BY END MOUNT
ESPECIFICACIONES POR TIPO DE MONTAJE
SPÉCIFICATIONS PAR FIXATION DES EXTRÉMITÉS

Fleetline	Mounting		Bore	External Diameter Illustration	Lengths			Dust Tube	Recoil Cutoff	Controls*	
	Upper	Lower			Extended	Collapsed	Stroke			Rebound	Compression
83312	EB2	EB2	1-3/8"	B	26.64	16.11	10.53	YES	YES	527	152
89409	EB2	EB2	1-5/8"	G	26.36	16.41	9.95	YES	YES	567‡	165
89439	EB2	EB2	1-5/8"	G	25.67	15.79	9.88	YES	NO	518‡	103
85055	EB2	EB2	1-5/8"	C	25.63	15.6	10.03	YES	NO	577	102
85047	EB2	EB2	1-5/8"	C	25.25	15.47	9.78	YES	YES	1008	539
83308	EB2	EB2	1-3/8"	B	25.14	15.36	9.78	YES	YES	445	180
89435	EB2	EB2	1-5/8"	G	24.86	15.66	9.2	YES	YES	1155‡	514
83200	EB2	EB2	1-3/8"	A	24.51	15.1	9.53	YES	NO	806	370
89402	EB2	EB2	1-5/8"	G	24.41	15.16	9.25	YES	NO	874‡	206
83519	EB2	EB2	1-3/16"		23.83	14.35	9.48	YES	NO	292	132
83216	EB2	EB2	1-3/8"	A	23.51	14.48	9.03	YES	YES	776	262
85054	EB2	EB2	1-5/8"	C	23.26	14.35	8.91	YES	NO	602	104
89438	EB2	EB2	1-5/8"	G	23.17	14.54	8.63	YES	NO	583‡	103
83404	EB2	EB2	1-3/16"	F	22.01	13.44	8.58	YES	NO	545	171
83159	EB2	EB2	1-3/8"	A	21.62	13.4	8.14	YES	NO	658	149
85012	EB2	EB2	1-5/8"	C	21	13.22	7.78	YES	NO	523	199
89413	EB2	EB2	1-5/8"	G	20.91	13.41	7.5	YES	NO	536‡	201
85023	EB2	EB2	1-5/8"	C	20.24	12.96	7.28	YES	YES	1008	539
89415	EB2	EB2	1-5/8"	G	20.12	13.29	6.83	YES	YES	1155‡	514
83219	EB2	EB2	1-3/8"	A	20.01	12.73	7.28	YES	YES	299	125
85062	EB2	EB2	1-5/8"	C	19.76	12.6	7.2	YES	NO	523	199
89408	EB2	EB2	1-5/8"	G	19.67	12.79	6.88	YES	NO	536‡	201
G63605	EB2	ES27	1-3/8"		24.24	14.71	9.53	YES	NO		
85025	EB2	S21	1-5/8"	C	23	13.97	9.03	YES	NO	1079	539
85376	EB3	EB3	1-5/8"	D	33.25	19.72	13.53	YES	NO	668	134
85301	EB3	EB3	1-5/8"	D	31.92	19.03	12.89	YES	NO	1442	455
85339	EB3	EB3	1-5/8"	D	31.68	19.02	12.66	YES	YES	804	463
85040	EB3	EB3	1-5/8"	C	30.9	18.49	12.41	YES	NO	889	114
85730	EB3	EB3	1-5/8"	D	30.75	18.72	12.03	YES	YES	1517	293
85315	EB3	EB3	1-5/8"	D	29.66	18.15	11.51	YES	NO	380	142
85901	EB3	EB3	1-5/8"	G	29.05	17.64	11.41	YES	NO	1830	418
85704	EB3	EB3	1-5/8"	D	28.75	18.72	10.03	YES	YES	1435	186
83104	EB3	EB3	1-3/8"	A	28.24	17.12	11.12	YES	NO	698	133
85305	EB3	EB3	1-5/8"	D	27.25	16.72	10.53	YES	NO	1120	225
83362	EB3	EB3	1-3/8"	B	27	16.25	10.75	YES	NO	539	202
87004	EB3	EB3	2-1/16"	E	26.76	16.76	10	YES	YES	1158	190
85735	EB3	EB3	1-5/8"	D	26.74	16.71	10.03	YES	YES	1288	227
83215	EB3	EB3	1-3/8"	A	26.64	16.36	10.28	YES	YES	697	108
85314	EB3	EB3	1-5/8"	D	26.5	16.47	10.03	YES	YES	1216	169
89425	EB3	EB3	1-5/8"	G	26.5	16.8	9.7	YES	YES	1352‡	167
89410	EB3	EB3	1-5/8"	G	26.33	16.42	9.91	YES	NO	1185‡	182
85001	EB3	EB3	1-5/8"	C	26.27	16.36	9.91	YES	NO	1202	186

* Damping force, in pounds, to either extend or collapse the shock absorber at an average operating velocity. Fuerza de amortiguación en libras para extender o comprimir el amortiguador a una velocidad de operación promedio. La puissance d'amortissement en poids de l'amortisseur, soit comprimé, doit détendu, à une vitesse de fonctionnement moyenne.

† At bumper contact / Al contacto con el tope de goma / Au contact avec le butoir

‡ For GasSLX Series, forces are at the "Firm" (F) setting. / Para la serie GasSLX, las fuerzas están ajustadas en (F) "Firme". / Pour la série GasSLX, le réglage de la force est sur «Firme» (F).

SPECIFICATIONS BY END MOUNT
ESPECIFICACIONES POR TIPO DE MONTAJE
SPÉCIFICATIONS PAR FIXATION DES EXTRÉMITÉS

Fleetline	Mounting		Bore	External Diameter Illustration	Lengths			Dust Tube	Recoil Cutoff	Controls*	
	Upper	Lower			Extended	Collapsed	Stroke			Rebound	Compression
85313	EB3	EB3	1-5/8"	D	26.26	16.35	9.91	YES	YES	717	111
87003	EB3	EB3	2-1/16"	E	26.26	16.51	9.75	YES	YES	1332	395
89429	EB3	EB3	1-5/8"	G	26.18	16.43	9.75	YES	NO	941‡	266
85320	EB3	EB3	1-5/8"	D	26.13	16.35	9.78	YES	NO	970	308
85700	EB3	EB3	1-5/8"	D	26.13	16.6	9.53	YES	YES	1446	328
83140	EB3	EB3	1-3/8"	A	25.27	15.52	9.75	YES	NO	738	88
83141	EB3	EB3	1-3/8"	A	25.27	15.52	9.75	YES	NO	408	113
83132	EB3	EB3	1-3/8"	A	25.24	15.5	9.74	YES	NO	828	150
85308	EB3	EB3	1-5/8"	D	25.13	15.85	9.28	YES	YES	764	254
85714	EB3	EB3	1-5/8"	D	25.13	15.85	9.28	YES	YES	1220	175
85715	EB3	EB3	1-5/8"	D	25.13	15.85	9.28	YES	YES	1915	200
85717	EB3	EB3	1-5/8"	D	25.13	15.85	9.28	YES	YES	1915	200
89422	EB3	EB3	1-5/8"	G	25.13	16.18	8.95	YES	YES	794‡	253
85303	EB3	EB3	1-5/8"	D	24.75	15.47	9.28	YES	NO	1019	221
85053	EB3	EB3	1-5/8"	C	24.65	15.49	9.16	YES	NO	1019	227
89442	EB3	EB3	1-5/8"	G	24.55	15.55	9	YES	NO	1055‡	224
85329	EB3	EB3	1-5/8"	D	24.5	15.47	9.03	YES	YES	1550	232
85713	EB3	EB3	1-5/8"	D	24.5	15.47	9.03	YES	YES	1157	180
89412	EB3	EB3	1-5/8"	G	24.26	15.68	8.58	YES	YES	1155‡	169
85007	EB3	EB3	1-5/8"	C	24.21	15.3	8.91	YES	YES	1008	171
83225	EB3	EB3	1-3/8"	A	24.14	15.11	9.03	YES	YES	482	159
85307	EB3	EB3	1-5/8"	D	24.01	15.1	8.91	YES	NO	1094	173
85702	EB3	EB3	1-5/8"	D	23.76	15.85	7.91	YES	YES	1093	825
87006	EB3	EB3	2-1/16"	E	23.75	15.25	8.5	YES	YES	1158	272
85736	EB3	EB3	1-5/8"	D	23.62	15.21	8.41	YES	YES	1155	352
87002	EB3	EB3	2-1/16"	E	23.5	15.41	8.09	YES	YES	879	203
89420	EB3	EB3	1-5/8"	G	22.81	14.68	8.13	YES	NO	862‡	258
83217	EB3	EB3	1-3/8"	A	22.77	14.49	8.28	YES	YES	539	202
85302	EB3	EB3	1-5/8"	D	22.75	14.66	8.09	YES	NO	836	253
85304	EB3	EB3	1-5/8"	D	22.25	14.22	8.03	YES	NO	767	325
85718	EB3	EB3	1-5/8"	D	22.13	15.04	7.09	YES	YES	2506	206
85732	EB3	EB3	2-1/16"	E	22.13	15.11	7.03	YES	YES	2632	382
85716	EB3	EB3	1-5/8"	D	22.01	14.35	7.66	YES	YES	1220	175
87001	EB3	EB3	2-1/16"	E	20.76	13.76	7	YES	YES	1158	190
85734	EB3	EB3	1-5/8"	D	20.74	13.71	7.03	YES	YES	1288	227
85004	EB3	EB3	1-5/8"	C	20.68	13.67	7.01	YES	YES	1019	219
85042	EB3	EB3	1-5/8"	C	20.64	13.61	7.03	YES	YES	333	161
85712	EB3	EB3	1-5/8"	D	20.5	13.47	7.03	YES	YES	1435	562
85720	EB3	EB3	1-5/8"	D	20.5	13.47	7.03	YES	YES	1435	562
85968	EB3	EB3	1-5/8"	G	19.87	13.39	6.48	YES	YES	1069	227
83214	EB3	EB3	1-3/8"	A	19.64	12.86	6.78	YES	YES	269	90
85300	EB3	EB3	1-5/8"	D	18	12.22	5.78	YES	YES	1435	676

* Damping force, in pounds, to either extend or collapse the shock absorber at an average operating velocity. Fuerza de amortiguación en libras para extender o comprimir el amortiguador a una velocidad de operación promedio. La puissance d'amortissement en poids de l'amortisseur, soit comprimé, doit détendu, à une vitesse de fonctionnement moyenne.

† At bumper contact / Al contacto con el tope de goma / Au contact avec le butoir

‡ For GasSLX Series, forces are at the "Firm" (F) setting. / Para la serie GasSLX, las fuerzas están ajustadas en (F) "Firme". / Pour la série GasSLX, le réglage de la force est sur «Firme» (F).

SPECIFICATIONS BY END MOUNT
ESPECIFICACIONES POR TIPO DE MONTAJE
SPÉCIFICATIONS PAR FIXATION DES EXTRÉMITÉS

Fleetline	Mounting		Bore	External Diameter Illustration	Lengths			Dust Tube	Recoil Cutoff	Controls*	
	Upper	Lower			Extended	Collapsed	Stroke			Rebound	Compression
89419	EB3	EB3	1-5/8"	G	18	12.55	5.45	YES	YES	1352‡	636
85719	EB3	EB3	1-5/8"	D	17.25	11.97	5.28	YES	YES	1517	213
85334	EB3	EB3	1-5/8"	D	14.5	10.47	4.03	YES	YES	1271	319
85912	EB3	ES36	1-5/8"	G	18.68	12.57	6.11	YES	YES	1020	219
85327	EB3	ES160	1-5/8"	D	16.01	12.1	3.91	YES	YES	764	162
85322	EB3	ES160	1-5/8"	D	15.26	11.85	3.41	YES	YES	764	162
83353	EB3	S21	1-3/8"	B	24.84	15.06	9.78	YES	NO	432	214
85740	EB3	S21	1-5/8"	D	24.7	15.15	9.55	YES	YES	848	305
85380	EB3	S21	1-5/8"	D	23.95	14.79	9.15	YES	YES	1568	227
85312	EB3	S21	1-5/8"	D	23.69	14.85	8.84	YES	YES	717	111
85733	EB3	S21	1-5/8"	D	23.57	14.73	8.84	YES	YES	717	111
85379	EB3	S21	1-5/8"	D	22.69	14.4	8.29	YES	YES	1658	176
85330	EB3	S21	1-5/8"	D	22.44	14.16	8.28	YES	YES	1140	176
85729	EB3	S21	1-5/8"	D	21.58	13.8	7.78	YES	YES	783	111
85723	EB3	S21	1-5/8"	D	19.94	12.91	7.03	YES	YES	1318	248
83117	EB4	EB1	1-3/8"	A	23.94	14.45	9.49	YES	NO	354	300
G63183	EB4	EB4	1-3/8"		20.89	13.11	7.78	YES	NO		
83119	EB4	ES165	1-3/8"	A	23.96	14.84	9.12	YES	NO	354	300
G63355	EB7	ES24	1-3/8"		15	9.97	5.03	YES	NO		
83303	EB7	ES36	1-3/8"	B	24.86	15.08	9.78	YES	YES	470	122
83304	EB7	ES36	1-3/8"	B	22.86	14.08	8.78	YES	YES	470	122
G63625	EB7	ES36	1-3/8"		22.48	13.96	8.53	YES	NO		
G63306	ES2	ES24	1-3/8"		19.86	12.58	7.28	YES	NO		
G63347	ES3	ES24	1-3/8"		18.08	11.55	6.53	YES	NO		
G63455	ES8	ES83	1-3/8"		23	13.97	9.03	YES	NO		
83002	ES10	ES10	1-3/8"	A	11.61	8.62	3	YES	YES	3112	590
83024	ES10	ES10	1-3/8"	2-1/2" D/T	11.61	8.62	2.99	YES	YES	811	320
83016	ES10	ES10	1"	1-5/8"	11.51	8.14	3.37	NO	YES	506	139
83031	ES10	ES10	1-3/8"	2-1/2" D/T	11.49	8.62	2.87	YES	YES	811	314
83051	ES10	ES10	1-3/8"	2-1/2" D/T	9.41	7.4	2.01	YES	YES	579	163
83061	ES10	ES10	1-3/8"	2-1/2" D/T	9.41	7.4	2.01	YES	YES	1030	220
83021	ES10	ES10	1-3/8"	A	9.36	7.37	1.99	YES	YES	745	315
83046	ES10	ES181	1-3/16"		9.23†	7.62†	2.73	NO	YES	514	173
83023	ES10	ES181	1"	1-5/8"	8.7	7.09†	2.14	NO	YES	484	157
83045	ES19	S10	1-3/8"	A	11.53†	8.58†	3.81	YES	NO	510	153
83050	ES19	S10	1-3/8"	A	10.43†	8.38†	2.9	YES	YES	599	321
83058	ES19	S10	1-3/8"	A	10.43†	8.38†	2.9	YES	YES	742	243
83158	ES22	ES22	1-3/8"	A	12.96	8.97	4	YES	NO	783	484
83010	ES24	ES24	1"	2" D/T	14.15†	9.33	5.07	YES	YES	188	70
G63357	ES24	ES24	1-3/8"		15	9.97	5.03	YES	NO		
83022	ES24	ES24	1"	2" D/T	14.28	9.33	4.95	YES	NO	840	152
83026	ES24	ES24	1-3/8"	A	13.11	9.12	3.99	YES	YES	602	104

* Damping force, in pounds, to either extend or collapse the shock absorber at an average operating velocity. Fuerza de amortiguación en libras para extender o comprimir el amortiguador a una velocidad de operación promedio. La puissance d'amortissement en poids de l'amortisseur, soit comprimé, doit détendu, à une vitesse de fonctionnement moyenne.

† At bumper contact / Al contacto con el tope de goma / Au contact avec le butoir

‡ For GasSLX Series, forces are at the "Firm" (F) setting. / Para la serie GasSLX, las fuerzas están ajustadas en (F) "Firme". / Pour la série GasSLX, le réglage de la force est sur «Ferme» (F).

SPECIFICATIONS BY END MOUNT
ESPECIFICACIONES POR TIPO DE MONTAJE
SPÉCIFICATIONS PAR FIXATION DES EXTRÉMITÉS

Fleetline	Mounting		Bore	External Diameter Illustration	Lengths			Dust Tube	Recoil Cutoff	Controls*	
	Upper	Lower			Extended	Collapsed	Stroke			Rebound	Compression
83018	ES24	S10	1-3/8"	A	10.3†	8.42†	3.24	YES	YES	515	174
83027	ES24	S10	1-3/8"	A	13.8	9.18	4.62	YES	YES	602	104
83019	ES24	S10	1-3/8"	A	9.42	8.16†	2.28	YES	YES	509	121
83044	ES27	ES164	1-3/8"	A	10.91	7.93	2.98	YES	YES	789	296
G63866	ES34	ES34	1-3/8"		22.81	14.12	8.69				
83153	ES34	ES34	1-3/8"	A	21.69	13.62	8.07	YES	YES	974	206
83155	ES34	ES34	1-3/8"	A	21.69	13.62	8.07	YES	YES	507	80
83059	ES35	ES35	1-3/8"	A	12.06†	8.68	3.88	YES	YES	738	350
83004	ES35	ES136	1"	2" D/T	9.36†	7.29	2.32	YES	YES	539	324
85905	ES36	EB3	1-5/8"	G	23.81	16.16	7.66	YES	YES	1020	219
85913	ES36	EB3	1-5/8"	G	22.56	15.2	7.36	YES	YES	1020	219
85057	ES36	EB3	1-5/8"	C	21.45	14.23	7.22	YES	YES	1216	115
85907	ES36	EB3	1-5/8"	G	21.43	14.2	7.23	YES	YES	1216	251
83113	ES36	EB3	1-3/8"	A	20.42	13.43	6.99	YES	YES	997	238
85059	ES36	EB3	1-5/8"	C	19.07	12.79	6.28	YES	YES	928	151
85915	ES36	EB3	1-5/8"	G	19.06	12.7	6.36	YES	YES	1020	219
83115	ES36	EB3	1-3/8"	A	16.19	13.32	4.87	YES	YES	997	238
83242	ES36	ES36	1-3/8"	A	33.73	20.98	12.75	YES	YES	721	135
85903	ES36	ES36	1-5/8"	G	31.99	19.13	12.86	YES	YES	666	113
85979	ES36	ES36	1-5/8"	G	31.17	18.66	12.52	YES	YES	582	138
85972	ES36	ES36	1-5/8"	G	30.78	18.26	12.52	YES	NO	1493	261
83121	ES36	ES36	1-3/8"	A	30.25	18.32	11.93	YES	YES	689	126
83137	ES36	ES36	1-3/8"	A	30.03	17.78	12.25	YES	YES	517	132
85976	ES36	ES36	1-5/8"	G	29.91	18.13	11.79	YES	YES	582	138
85013	ES36	ES36	1-5/8"	C	29.74	17.71	12.03	YES	YES	1019	219
83205	ES36	ES36	1-3/8"	A	29.69	17.69	12	YES	YES	660	76
83209	ES36	ES36	1-3/8"	A	29.64	17.61	12.03	YES	YES	670	78
89414	ES36	ES36	1-5/8"	G	29.62	18.04	11.58	YES	YES	1045‡	217
85337	ES36	ES36	1-5/8"	D	28.72	17.45	11.28	YES	YES	1318	374
85006	ES36	ES36	1-5/8"	C	28.5	17.09	11.41	YES	YES	1019	219
83125	ES36	ES36	1-3/8"	A	28.12	17.13	10.99	YES	YES	625	115
85097	ES36	ES36	1-5/8"	C	27.95	17.11	10.84	YES	YES	1086	109
85043	ES36	ES36	1-5/8"	C	27.63	16.85	10.78	YES	YES	628	163
85904	ES36	ES36	1-5/8"	G	27.61	16.88	10.73	YES	YES	666	113
85010	ES36	ES36	1-5/8"	C	26.74	16.21	10.53	YES	YES	1019	219
83123	ES36	ES36	1-3/8"	A	26.62	16.38	10.24	YES	YES	589	119
83176	ES36	ES36	1-3/8"	A	26.62	15.96	10.66	NO	NO	406	275
85036	ES36	ES36	1-5/8"	C	26.38	16.29	10.09	YES	YES	633	119
89405	ES36	ES36	1-5/8"	G	26.24	16.41	9.83	YES	YES	1009‡	249
85099	ES36	ES36	1-5/8"	C	26.02	15.93	10.09	YES	YES	1152	135
85974	ES36	ES36	1-5/8"	G	26.02	16.11	9.91	YES	YES	3087	230
85321	ES36	ES36	1-5/8"	D	25.36	15.58	9.78	YES	YES	1435	676

* Damping force, in pounds, to either extend or collapse the shock absorber at an average operating velocity. Fuerza de amortiguación en libras para extender o comprimir el amortiguador a una velocidad de operación promedio. La puissance d'amortissement en poids de l'amortisseur, soit comprimé, doit détendu, à une vitesse de fonctionnement moyenne.

† At bumper contact / Al contacto con el tope de goma / Au contact avec le butoir

‡ For GasSLX Series, forces are at the "Firm" (F) setting. / Para la serie GasSLX, las fuerzas están ajustadas en (F) "Firme". / Pour la série GasSLX, le réglage de la force est sur «Firme» (F).

SPECIFICATIONS BY END MOUNT
ESPECIFICACIONES POR TIPO DE MONTAJE
SPÉCIFICATIONS PAR FIXATION DES EXTRÉMITÉS

Fleetline	Mounting		Bore	External Diameter Illustration	Lengths			Dust Tube	Recoil Cutoff	Controls*	
	Upper	Lower			Extended	Collapsed	Stroke			Rebound	Compression
83149	ES36	ES36	1-3/8"	A	25.28	15.78	9.49	YES	YES	332	101
83122	ES36	ES36	1-3/8"	A	25.24	15.75	9.49	YES	YES	661	201
83218	ES36	ES36	1-3/8"	A	25.19	15.44	9.75	YES	YES	721	194
665472	ES36	ES36	1-5/8"	G	25.14	15.61	9.53	NO	NO	925	977
85005	ES36	ES36	1-5/8"	C	24.74	15.21	9.53	YES	YES	1019	219
89406	ES36	ES36	1-5/8"	G	24.74	15.66	9.08	YES	YES	658‡	125
85916	ES36	ES36	1-5/8"	G	24.61	15.51	9.11	YES	YES	1149	219
89430	ES36	ES36	1-5/8"	G	24.6	15.39	9.53	YES	YES	1462‡	279
83126	ES36	ES36	1-3/8"	A	24.37	15.25	9.12	YES	YES	625	115
85909	ES36	ES36	1-5/8"	G	24.24	15.13	9.11	YES	YES	700	255
85975	ES36	ES36	1-5/8"	G	24.24	15.15	9.09	YES	YES	1658	219
83310	ES36	ES36	1-3/8"	B	24.06	14.69	9.37	YES	NO	559	153
83221	ES36	ES36	1-3/8"	A	24.01	14.73	9.28	YES	YES	599	153
85030	ES36	ES36	1-5/8"	C	24	14.84	9.16	YES	YES	1019	219
89440	ES36	ES36	1-5/8"	G	23.86	15.16	8.7	YES	YES	1498‡	561
83144	ES36	ES36	1-3/8"	A	23.78	15.03	8.75	YES	YES	596	93
89432	ES36	ES36	1-5/8"	G	23.41	14.66	8.75	YES	NO	1507‡	561
85050	ES36	ES36	1-5/8"	C	23.28	14.5	9.03	YES	NO	525	138
665937	ES36	ES36	1-5/8"	G	22.91	16.09	6.82	YES	NO		
85044	ES36	ES36	1-5/8"	C	22.63	14.1	8.53	YES	NO	722	212
85058	ES36	ES36	1-5/8"	C	22.63	14.22	8.41	YES	YES	722	114
85971	ES36	ES36	1-5/8"	G	22.55	14.17	8.38	YES	NO	2315	451
85919	ES36	ES36	1-5/8"	G	22.48	14.25	8.23	YES	YES	1265	121
632155	ES36	ES36	1-3/16"		22.45	14.1	8.35	NO	NO		
646155	ES36	ES36	1-3/16"		22.45	14.1	8.35	YES	NO		
646177	ES36	ES36	1-3/16"		22.45	14.1	8.35	NO	NO		
89431	ES36	ES36	1-5/8"	G	22.41	14.16	8.25	YES	NO	751‡	211
85345	ES36	ES36	1-5/8"	D	21.83	13.82	8.01	YES	YES	1093	219
85014	ES36	ES36	1-5/8"	C	21.74	13.71	8.03	YES	YES	1019	219
85906	ES36	ES36	1-5/8"	G	21.73	14	7.73	YES	YES	700	255
83124	ES36	ES36	1-3/8"	A	21.65	13.75	7.87	YES	YES	750	137
83207	ES36	ES36	1-3/8"	A	21.64	13.61	8.03	YES	YES	553	143
89407	ES36	ES36	1-5/8"	G	21.62	14.04	7.58	YES	YES	652‡	218
85091	ES36	ES36	1-5/8"	C	21.38	13.56	7.82	YES	NO	1121	331
85910	ES36	ES36	1-5/8"	G	20.73	13.5	7.23	YES	YES	1074	219
85029	ES36	ES36	1-5/8"	C	20.5	13.09	7.41	YES	YES	1019	219
85382	ES36	ES36	1-5/8"	D	20.22	13.07	7.15	YES	YES	1658	420
83204	ES36	ES36	1-3/8"	A	20.14	12.86	7.28	YES	YES	451	110
83127	ES36	ES36	1-3/8"	A	20.12	13.13	6.99	YES	YES	940	218
89437	ES36	ES36	1-5/8"	G	20.12	13.29	6.83	YES	YES	1155‡	514
85060	ES36	ES36	1-5/8"	C	19.75	12.72	7.03	YES	YES	943	405
85338	ES36	ES36	1-5/8"	D	19.47	12.7	6.77	YES	YES	1664	420

* Damping force, in pounds, to either extend or collapse the shock absorber at an average operating velocity. Fuerza de amortiguación en libras para extender o comprimir el amortiguador a una velocidad de operación promedio. La puissance d'amortissement en poids de l'amortisseur, soit comprimé, doit détendu, à une vitesse de fonctionnement moyenne.

† At bumper contact / Al contacto con el tope de goma / Au contact avec le butoir

‡ For GasSLX Series, forces are at the "Firm" (F) setting. / Para la serie GasSLX, las fuerzas están ajustadas en (F) "Firme". / Pour la série GasSLX, le réglage de la force est sur «Ferme» (F).

SPECIFICATIONS BY END MOUNT
ESPECIFICACIONES POR TIPO DE MONTAJE
SPÉCIFICATIONS PAR FIXATION DES EXTRÉMITÉS

Fleetline	Mounting		Bore	External Diameter Illustration	Lengths			Dust Tube	Recoil Cutoff	Controls*	
	Upper	Lower			Extended	Collapsed	Stroke			Rebound	Compression
85051	ES36	ES36	1-5/8"	C	18.53	12.15	6.4	YES	YES	1019	139
85908	ES36	ES36	1-5/8"	G	18.48	12.25	6.23	YES	YES	1020	219
83130	ES36	ES36	1-3/8"	A	18.03	12.04	5.99	YES	YES	871	177
85934	ES36	ES36	1-5/8"	G	17.73	12	5.73	YES	YES	3511	1063
85086	ES36	ES36	1-5/8"	C	17.55	11.63	5.92	YES	YES	2027	389
85738	ES36	ES36	1-5/8"	D	17.47	11.7	5.77	YES	YES	1830	416
85323	ES36	ES36	1-5/8"	D	17.36	11.58	5.78	YES	YES	1085	163
87018	ES36	ES36	2-1/16"	E	17.36	11.71	5.65	YES	YES	2479	1000
83389	ES36	ES36	1-3/8"	A	17.32	11.57	5.75	YES	YES	1084	228
89436	ES36	ES36	1-5/8"	G	17.24	11.91	5.33	YES	YES	998‡	217
85000	ES36	ES36	1-5/8"	C	17.22	11.46	5.76	YES	YES	1019	219
83203	ES36	ES36	1-3/8"	A	17.1	11.36	5.74	YES	YES	609	114
83128	ES36	ES36	1-3/8"	A	16.87	11.51	5.37	YES	YES	940	218
85911	ES36	ES36	1-5/8"	G	16.86	11.5	5.36	YES	YES	1020	219
85938	ES36	ES36	1-5/8"	G	16.06	10.78	5.28	YES	YES	1581	432
85064	ES36	ES36	1-5/8"	C	16.03	10.76	5.27	YES	YES	1481	340
83150	ES36	ES36	1-3/8"	A	15.24	10.43	4.81	YES	YES	940	216
85078	ES36	ES36	1-5/8"	C	14.77	10.13	4.64	YES	YES	1409	282
85045	ES36	ES36	1-5/8"	C	14.51	10.1	4.41	YES	YES	1020	219
85939	ES36	ES36	1-5/8"	G	14.44	10.03	4.41	YES	YES	1719	420
85914	ES36	ES36	1-5/8"	G	14.36	10.25	4.11	YES	YES	1020	219
85052	ES36	ES36	1-5/8"	C	13.25	9.47	3.78	YES	YES	1019	139
85344	ES36	ES36	1-5/8"	D	13.22	9.45	3.77	YES	YES	1581	443
85079	ES36	ES36	1-5/8"	C	12.04	8.87	3.17	YES	YES	1494	325
83157	ES36	ES90	1-3/8"	A	26.38	15.76	10.61	YES	NO	446	303
85102	ES36	ES136	1-5/8"	C	21.53	14.94	6.59	YES	YES	1224	342
83164	ES36	ES165	1-3/8"	C	24.22	14.59	9.63	YES	NO	426	274
85072	ES36	ES176	1-5/8"	C	24.17	14.83	9.34	YES	YES	1387	305
85087	ES36	ES176	1-5/8"	C	22.79	14.71	8.08	YES	YES	1568	403
85109	ES36	ES195	1-5/8"	C	24.21	15.14	9.07	YES	YES	1123	149
83635	ES36	S21	1-3/8"	A	21.74	13.25	8.49	YES	NO	558	119
85977	ES36	S42	1-5/8"	G	26.2	15.91	10.29	YES	YES	582	138
83109	ES36	S42	1-3/8"	A	26.14	15.9	10.24	YES	YES	345	78
83111	ES36	S42	1-3/8"	A	26.14	15.9	10.24	YES	YES	560	141
83138	ES36	S42	1-3/8"	A	23.55	14.42	9.12	YES	YES	997	231
83110	ES36	S42	1-3/8"	A	22.89	14.27	8.62	YES	YES	450	143
83112	ES36	S42	1-3/8"	A	21.52	13.4	8.12	YES	YES	1064	343
83033	ES53	ES53	1-3/8"	A	13.99	10.37	3.62	YES	YES	494	312
G63676	ES69	ES69	1-3/8"		15.58	10.55	5.03	YES	YES		
G63403	ES82	ES82	1-3/8"		24.58	14.8	9.78	YES	NO		
83131	ES83	ES83	1-3/8"	A	27.8	18.18	9.62	YES	NO	212	129
83145	ES83	ES83	1-3/8"	A	19.93	12.32	7.54	YES	NO	479	153

* Damping force, in pounds, to either extend or collapse the shock absorber at an average operating velocity. Fuerza de amortiguación en libras para extender o comprimir el amortiguador a una velocidad de operación promedio. La puissance d'amortissement en poids de l'amortisseur, soit comprimé, doit détendu, à une vitesse de fonctionnement moyenne.

† At bumper contact / Al contacto con el tope de goma / Au contact avec le butoir

‡ For GasSLX Series, forces are at the "Firm" (F) setting. / Para la serie GasSLX, las fuerzas están ajustadas en (F) "Firme". / Pour la série GasSLX, le réglage de la force est sur «Firme» (F).

SPECIFICATIONS BY END MOUNT
ESPECIFICACIONES POR TIPO DE MONTAJE
SPÉCIFICATIONS PAR FIXATION DES EXTRÉMITÉS

Fleetline	Mounting		Bore	External Diameter Illustration	Lengths			Dust Tube	Recoil Cutoff	Controls*	
	Upper	Lower			Extended	Collapsed	Stroke			Rebound	Compression
83048	ES86	ES167	1-3/8"	A	9.97	8.43†	2.37	YES	YES	904	415
83028	ES86	ES167	1-3/8"	A	9.94	7.57	2.37	YES	YES	445	531
85963	ES90	ES36	1-5/8"	G	25.49	18.68	6.81	YES	YES	1490	206
85964	ES90	ES36	1-5/8"	G	25.49	18.68	6.81	YES	YES	1981	205
85995	ES90	ES36	1-5/8"	G	23.5	14.52	8.98	YES	NO	1830	173
85994	ES90	ES36	1-5/8"	G	21.21	13.4	7.81	YES	NO	1824	263
85954	ES90	ES36	1-5/8"	G	20.43	12.96	7.46	YES	NO	1812	148
85924	ES90	ES36	1-5/8"	G	20.41	12.96	7.46	YES	NO	1036	122
89457	ES90	ES36	1-5/8"	G	19.95	12.71	6.97	YES	NO	941‡	156
85969	ES90	ES36	1-5/8"	G	18.38	11.93	6.45	YES	NO	1612	125
83180	ES90	ES83	1-3/8"		30.2	21.24	8.96	YES	NO	909	204
83146	ES90	ES83	1-3/8"	A	24.02	14.68	9.33	YES	YES	479	119
85082	ES90	ES90	1-5/8"	C	28.6	20.64	7.97	YES	YES	1435	266
83636	ES90	ES90	1-3/8"	A	27.72	16.95	10.77	YES	YES	505	148
83100	ES90	ES90	1-3/8"	A	26.6	16.11	10.49	YES	YES	481	142
85926	ES90	ES90	1-5/8"	G	26.48	17.96	8.53	YES	YES	1387	279
85953	ES90	ES90	1-5/8"	G	26.13	15.86	10.27	YES	NO	2001	153
85003	ES90	ES90	1-5/8"	C	25.37	15.59	9.78	YES	YES	437	182
89411	ES90	ES90	1-5/8"	G	25.36	15.59	9.78	YES	YES	436‡	186
85927	ES90	ES90	1-5/8"	G	24.74	15.38	9.36	YES	YES	1288	388
83101	ES90	ES90	1-3/8"	A	24.6	15.11	9.49	YES	YES	481	142
85998	ES90	ES90	1-5/8"	G	22.83	14.17	8.66	YES	NO	1345	178
85925	ES90	ES90	1-5/8"	G	22.54	15.59	6.96	YES	NO	761	144
85957	ES90	ES90	1-5/8"	G	20.78	13.15	7.63	YES	NO	1583	138
85928	ES90	ES90	1-5/8"	G	20.28	13.21	7.08	YES	NO	957	229
85929	ES90	ES90	1-5/8"	G	20.28	13.21	7.08	YES	NO	2214	267
85999	ES90	ES90	1-5/8"	G	19.84	12.79	7.05	YES	NO	2214	259
83167	ES90	ES90	1-3/8"	A	19.49	12.38	7.11	YES	NO	285	90
83135	ES90	ES90	1-3/8"	A	19.48	12.36	7.12	YES	NO	519	121
83156	ES90	ES90	1-3/8"	A	18.55	11.91	6.64	YES	NO	778	135
83169	ES90	ES90	1-3/8"	A	18.55	11.91	6.64	YES	NO	599	171
83020	ES91	ES91	1-3/8"	A	9.41	7.17	2.24	YES	YES	796	255
83034	ES115	ES115	1-3/16"	1-5/8"	10.04†	7.32	2.97	NO	YES	430	129
83634	ES120	ES120	1-3/8"	A	27.48	16.23	11.25	YES	YES	779	157
85011	ES120	ES121	1-5/8"	C	27.49	16.46	11.03	YES	NO	1268	186
85122	ES120	S21	1-5/8"	C	22.22	13.78	8.44	YES	YES	926	162
83120	ES120	S21	1-3/8"	A	22.12	13.63	8.49	YES	YES	779	164
85123	ES120	S21	1-5/8"	C	21.49	13.26	8.23	YES	NO	1809	246
83154	ES120	S21	1-3/8"	A	20.78	12.72	8.06	YES	YES	599	140
83160	ES128	ES36	1-3/8"	A	24.31	14.9	9.37	YES	YES	920	161
83174	ES128	ES36	1-3/8"	A	24.31	14.9	9.37	YES	YES	795	160
83042	ES136	ES136	1-3/8"	A	9.88†	8.44†	2.38	YES	YES	954	541

* Damping force, in pounds, to either extend or collapse the shock absorber at an average operating velocity. Fuerza de amortiguación en libras para extender o comprimir el amortiguador a una velocidad de operación promedio. La puissance d'amortissement en poids de l'amortisseur, soit comprimé, doit détendu, à une vitesse de fonctionnement moyenne.

† At bumper contact / Al contacto con el tope de goma / Au contact avec le butoir

‡ For GasSLX Series, forces are at the "Firm" (F) setting. / Para la serie GasSLX, las fuerzas están ajustadas en (F) "Firme". / Pour la série GasSLX, le réglage de la force est sur «Ferme» (F).

SPECIFICATIONS BY END MOUNT
ESPECIFICACIONES POR TIPO DE MONTAJE
SPÉCIFICATIONS PAR FIXATION DES EXTRÉMITÉS

Fleetline	Mounting		Bore	External Diameter Illustration	Lengths			Dust Tube	Recoil Cutoff	Controls*	
	Upper	Lower			Extended	Collapsed	Stroke			Rebound	Compression
83030	ES136	ES136	1-3/8"	A	9.6†	7.61	2.49	YES	YES	308	87
83008	ES136	ES136	1-3/8"	A	12.98†	10.15†	3.99	YES	YES	699	307
83056	ES136	ES136	1-5/8"	C	11.53	8.63	2.89	YES	YES	3830	737
85026	ES136	S21	1-5/8"	C	23	13.97	9.03	YES	NO	1079	539
89417	ES136	S21	1-5/8"	G	22.93	14.18	8.75	YES	NO	1226‡	515
83047	ES149	EB1	1-3/8"	A	11.78†	9.74†	3	YES	YES	364	314
83001	ES149	EB1	1-3/8"	A	10.41†	8.36†	3	YES	YES	793	363
83038	ES149	EB1	1-3/8"	A	10.41†	8.36†	2.99	YES	YES	336	242
83006	ES149	EB1	1-3/8"	A	10.66	8.48†	2.77	YES	YES	525	182
83009	ES149	ES149	1-3/8"	A	10.41†	8.36†	2.99	YES	YES	793	363
83039	ES149	ES149	1-3/8"	A	10.41†	8.36†	2.99	YES	YES	876	326
83064	ES149	ES149	1-3/8"	A	10.41†	8.36†	2.99	YES	YES	635	323
83017	ES149	ES149	1-3/8"	A	10.93	8.35†	3.13	YES	YES	353	138
85090	ES150	ES36	1-5/8"	C	25.31	15.52	9.78	YES	YES	943	99
85180	ES150	ES36	1-5/8"	C	20.94	13.83	7.11	YES	YES	681	283
85181	ES150	ES150	1-5/8"	C	26.33	17.06	9.27	YES	YES	681	285
89449	ES150	ES150	1-5/8"	G	23.09	14.71	8.38	YES	NO	1519‡	324
85918	ES150	ES150	1-5/8"	G	22.96	14.55	8.41	YES	NO	1726	412
85958	ES150	ES150	1-5/8"	G	22.96	14.55	8.41	YES	YES	1926	281
85119	ES150	ES150	1-5/8"	C	21.39	13.81	7.68	YES	YES	1387	185
85920	ES150	ES150	1-5/8"	G	21.19	13.53	7.66	YES	NO	845	49
85922	ES150	ES150	1-5/8"	G	21.19	13.53	7.66	YES	NO	878	185
85959	ES150	ES150	1-5/8"	G	21.19	13.53	7.66	YES	YES	1021	123
85106	ES150	ES150	1-5/8"	C	20.03	12.89	7.14	YES	YES	1054	109
85092	ES150	S21	1-5/8"	C	21.95	15.04	6.89	YES	YES	1597	138
83066	ES153	ES153	1-3/8"	A	11.15†	9.2†	2.78	YES	YES	599	221
85984	ES158	ES150	1-5/8"	G	25.44	15.96	9.48	YES	YES	2248	1168
85125	ES158	ES159	1-5/8"	C	26.9	16.64	10.26	YES	YES	1479	183
85724	ES158	ES159	1-5/8"	D	22.78	14.5	8.28	YES	YES	1235	454
89443	ES158	ES159	1-5/8"	G	22.17	14.31	7.86	YES	YES	1206‡	466
85331	ES158	ES159	1-5/8"	D	19.66	12.88	6.78	YES	YES	1757	396
85335	ES158	ES159	1-5/8"	D	19.66	12.88	6.78	YES	YES	827	107
85126	ES158	S21	1-5/8"	C	21.76	13.63	8.13	YES	YES	1086	215
87019	ES160	ES160	2-1/16"	E	24.84	15.85	8.9	YES	YES	2972	665
87017	ES160	ES160	2-1/16"	E	23.35	15.31	8.07	YES	YES	1876	220
89461	ES160	ES160	1-5/8"	G	19.96	13.58	6.38	YES	YES	897‡	103
85088	ES161	ES162	1-5/8"	C	25.31	15.52	9.78	YES	YES	616	178
85061	ES161	ES162	1-5/8"	C	24.75	15.22	9.53	YES	YES	1216	195
85098	ES161	ES162	1-5/8"	C	24.64	15.25	9.39	YES	YES	747	158
85066	ES161	ES162	1-5/8"	C	24.63	15.22	9.41	YES	YES	812	322
89448	ES161	ES162	1-5/8"	G	24.62	15.54	9.08	YES	YES	782‡	323
89450	ES161	ES162	1-5/8"	G	24.62	15.54	9.08	YES	YES	1282‡	193

* Damping force, in pounds, to either extend or collapse the shock absorber at an average operating velocity. Fuerza de amortiguación en libras para extender o comprimir el amortiguador a una velocidad de operación promedio. La puissance d'amortissement en poids de l'amortisseur, soit comprimé, doit détendu, à une vitesse de fonctionnement moyenne.

† At bumper contact / Al contacto con el tope de goma / Au contact avec le butoir

‡ For GasSLX Series, forces are at the "Firm" (F) setting. / Para la serie GasSLX, las fuerzas están ajustadas en (F) "Firme". / Pour la série GasSLX, le réglage de la force est sur «Ferme» (F).

SPECIFICATIONS BY END MOUNT
ESPECIFICACIONES POR TIPO DE MONTAJE
SPÉCIFICATIONS PAR FIXATION DES EXTRÉMITÉS

Fleetline	Mounting		Bore	External Diameter Illustration	Lengths			Dust Tube	Recoil Cutoff	Controls*	
	Upper	Lower			Extended	Collapsed	Stroke			Rebound	Compression
85065	ES161	S21	1-5/8"	C	28.02	16.99	11.03	YES	YES	1059	300
85083	ES162	S42	1-5/8"	C	27.81	16.53	11.28	YES	YES	1429	184
83142	ES162	S42	1-3/8"	A	23.92	14.5	9.43	YES	YES	367	131
83143	ES162	S42	1-3/8"	A	21.92	13.5	8.43	YES	YES	403	137
83049	ES163	ES163	1-3/8"	A	8.02	6.53	1.48	YES	YES	2879	705
83025	ES163	ES163	1-3/8"	A	7.98	6.49	1.49	YES	YES	710	230
83032	ES163	ES163	1-3/8"	A	7.85	6.36	1.49	NO	YES	779	135
83118	ES164	ES90	1-3/8"	A	24.45	14.71	9.74	YES	NO	410	311
83116	ES164	ES165	1-3/8"	A	23.81	14.68	9.12	YES	NO	354	300
83035	ES166	ES136	1-3/8"	A	12.96†	9.33	4.13	YES	YES	320	100
83067	ES166	ES136	1-3/16"	2" D/T	12.33†	9.27†	3.56	YES	YES	424	101
83029	ES168	ES169	1-5/8"	C	10.35	7.94	2.41	YES	NO	1303	1349
83057	ES171	ES172	1-3/8"	2-1/2" D/T	10.44†	8.4†	2.99	YES	YES	364	242
83040	ES171	ES172	1-3/8"	A	10.41†	8.36†	2.99	YES	YES	876	326
87015	ES173	ES173	45MM	E	15.51	11.18	4.33	YES	YES	4950	900
85737	ES173	ES173	1-5/8"	D	15.11	10.84	4.27	YES	YES	3066	782
89459	ES174	EB3	1-5/8"	G	25.62	15.86	9.78	YES	NO	1179‡	314
85070	ES174	EB3	1-5/8"	C	25.6	15.82	9.78	YES	NO	1100	310
85067	ES174	ES136	1-5/8"	C	30.51	18.1	12.41	YES	YES	676	170
89451	ES174	ES136	1-5/8"	G	30.36	18.41	11.95	YES	YES	645‡	172
85989	ES174	ES136	1-5/8"	G	20.78	13.15	7.63	YES	NO	1812	351
85084	ES174	ES136	1-5/8"	C	20.59	13.03	7.57	YES	NO	1145	407
89460	ES174	ES136	1-5/8"	G	20.58	13.03	7.55	YES	NO	997‡	384
85985	ES174	S43	1-5/8"	G	19.04	12.31	6.73	YES	YES	2068	723
85937	ES174	S43	1-5/8"	G	18.98	12.26	6.72	YES	YES	1479	337
85936	ES174	S43	1-5/8"	G	17.23	11.38	5.85	YES	YES	1479	337
89456	ES174	S43	1-5/8"	G	17.02	11.29	5.73	YES	YES	975‡	377
83063	ES175	ES136	1-3/8"	A	10.76†	9.26†	3.01	YES	YES	954	541
85955	ES175	ES150	1-5/8"	G	21.25	13.66	7.59	YES	YES	1034	397
85986	ES175	ES150	1-5/8"	G	21.25	13.66	7.59	YES	YES	1754	221
85120	ES175	ES175	1-5/8"	C	23.67	15.06	8.61	YES	NO	2083	519
83163	ES175	ES175	1-3/8"	A	20.75	13.01	7.74	YES	NO	828	98
83175	ES175	ES175	1-3/8"	A	20.48	13.19	7.29	YES	NO	1245	156
85933	ES175	ES175	1-5/8"	G	18.23	12.71	5.52	YES	YES	1089	383
89454	ES175	ES175	1-5/8"	G	18.23	12.78	5.45	YES	YES	938‡	388
85081	ES175	S21	1-5/8"	C	23.44	14.33	9.11	YES	YES	1658	250
85080	ES175	S21	1-5/8"	C	22.51	13.78	8.74	YES	NO	447	138
85031	ES176	EB2	1-5/8"	C	25.63	15.85	9.78	YES	NO	941	257
85923	ES177	ES161	1-5/8"	G	22.48	14.5	7.98	YES	YES	1940	221
85931	ES177	ES161	1-5/8"	G	22.48	14.5	7.98	YES	YES	1435	220
89458	ES177	ES161	1-5/8"	G	22.47	14.25	7.95	YES	YES	1575‡	222
85930	ES177	ES161	1-5/8"	G	17.86	12	5.86	YES	YES	1617	342

* Damping force, in pounds, to either extend or collapse the shock absorber at an average operating velocity. Fuerza de amortiguación en libras para extender o comprimir el amortiguador a una velocidad de operación promedio. La puissance d'amortissement en poids de l'amortisseur, soit comprimé, doit détendu, à une vitesse de fonctionnement moyenne.

† At bumper contact / Al contacto con el tope de goma / Au contact avec le butoir

‡ For GasSLX Series, forces are at the "Firm" (F) setting. / Para la serie GasSLX, las fuerzas están ajustadas en (F) "Firme". / Pour la série GasSLX, le réglage de la force est sur «Firme» (F).

SPECIFICATIONS BY END MOUNT
ESPECIFICACIONES POR TIPO DE MONTAJE
SPÉCIFICATIONS PAR FIXATION DES EXTRÉMITÉS

Fleetline	Mounting		Bore	External Diameter Illustration	Lengths			Dust Tube	Recoil Cutoff	Controls*	
	Upper	Lower			Extended	Collapsed	Stroke			Rebound	Compression
85932	ES178	ES150	1-5/8"	G	21.23	13.62	7.61	YES	YES	1102	430
89453	ES178	ES150	1-5/8"	G	21.1	13.78	7.32	YES	YES	860‡	435
85965	ES178	ES161	1-5/8"	G	24.24	15.15	9.09	YES	YES	2206	238
85966	ES178	ES161	1-5/8"	G	23.25	14.64	8.62	YES	YES	2206	238
85967	ES178	ES176	1-5/8"	G	23.93	14.86	9.07	YES	YES	2206	238
85961	ES178	ES176	1-5/8"	G	22.83	14.17	8.66	YES	YES	2206	240
85962	ES178	ES176	1-5/8"	G	21.8	13.66	8.15	YES	YES	2206	240
85980	ES179	ES179	1-5/8"	G	31.17	18.66	12.52	YES	YES	582	138
83148	ES179	ES179	1-3/8"	A	30	17.83	12.17	YES	YES	604	149
85978	ES179	ES179	1-5/8"	G	29.91	18.13	11.79	YES	YES	582	138
83147	ES179	ES179	1-3/8"	A	28.53	17.34	11.15	YES	YES	358	128
83166	ES179	ES179	1-3/8"	A	25.28	15.78	9.49	YES	YES	622	132
83168	ES179	ES179	1-3/8"	A	25.28	15.78	9.49	YES	YES	246	88
85377	ES182	ES182	1-5/8"	D	23.8	14.84	8.96	YES	YES	1937	570
85378	ES182	ES182	1-5/8"	D	23.8	14.84	8.96	YES	YES	1110	240
85956	ES183	ES184	1-5/8"	G	30.63	18.75	11.87	YES	YES	979	373
83053	ES185	ES185	1-3/8"	A	10.91	7.93	2.97	YES	YES	968	214
83054	ES185	ES185	1-3/8"	A	10.28	7.56	2.72	YES	YES	1004	184
83052	ES185	ES185	1-3/8"	2-1/2" D/T	9.41	7.19	2.23	YES	NO	1101	149
83062	ES185	S42	1-3/8"	A	12.71	9.18	3.53	YES	NO	704	153
85739	ES187	ES187	1-5/8"	D	20.73	13.54	7.19	YES	YES	3247	334
85341	ES188	S21	1-5/8"	D	30.95	18.1	12.85	YES	YES	1807	333
85970	ES188	S21	1-5/8"	G	27.19	16.4	10.78	YES	YES	1092	147
85340	ES188	S21	1-5/8"	D	26.46	15.85	10.61	YES	YES	1807	165
86203	ES193	ES193	45 MM	D	16.88	11.61	5.27	YES	YES	4238	910
86202	ES193	ES193	45 MM	D	14.52	10.43	4.09	YES	YES	4238	688
86201	ES193	ES193	45 MM	D	13.26	9.94	3.32	YES	YES	4238	688
86200	ES194	ES194	45 MM	D	14.24	10.45	3.79	YES	YES	4238	688
83065	ES206	ES171	1-5/8"	G	12.52	9.32	3.2	YES	YES	680‡	184
83003	S1	BP7	1-3/8"	A	11.76	8.95†	3.4	YES	YES	248	100
G63610	S1	EB1	1-3/8"		21.55	13.27	8.28	YES	NO		
83161	S1	EB1	1-3/8"	A	20.82	12.56	8.25	YES	NO	400	70
83518	S1	EB2	1-3/16"		24.4	14.26	10.14	YES	NO	153	82
83515	S1	EB2	1-3/16"		23.34	13.89	9.45	YES	NO	643	205
G63432	S1	EB2	1-3/8"		21.21	12.93	8.28	YES	NO		
G63387	S1	ES25	1-3/8"		23.33	14.05	9.28	YES	NO		
G63511	S1	ES25	1-3/8"		22.55	13.52	9.03	YES	NO		
G63350	S1	ES25	1-3/8"		18.83	11.8	7.03	YES	NO		
83400	S1	S1	1-3/16"	F	22.02	12.82	9.2	YES	NO	301	120
G63398	S1	S1	1-3/8"		20.52	12.24	8.28	YES	NO		
83014	S1	S1	1-3/8"	A	10.48	7.11	3.37	NO	NO	544	501
G63484	S4	EB1	1-3/8"		20.05	12.52	7.53	YES	NO		

* Damping force, in pounds, to either extend or collapse the shock absorber at an average operating velocity. Fuerza de amortiguación en libras para extender o comprimir el amortiguador a una velocidad de operación promedio. La puissance d'amortissement en poids de l'amortisseur, soit comprimé, doit détendu, à une vitesse de fonctionnement moyenne.

† At bumper contact / Al contacto con el tope de goma / Au contact avec le butoir

‡ For GasSLX Series, forces are at the "Firm" (F) setting. / Para la serie GasSLX, las fuerzas están ajustadas en (F) "Firme". / Pour la série GasSLX, le réglage de la force est sur «Firme» (F).

SPECIFICATIONS BY END MOUNT
ESPECIFICACIONES POR TIPO DE MONTAJE
SPÉCIFICATIONS PAR FIXATION DES EXTRÉMITÉS

Fleetline	Mounting		Bore	External Diameter Illustration	Lengths			Dust Tube	Recoil Cutoff	Controls*	
	Upper	Lower			Extended	Collapsed	Stroke			Rebound	Compression
G63714	S6	BP7	1-3/8"		15.54	10.01	5.53	YES	NO		
G63772	S6	BP35	1-3/8"		13.83	9.55	4.28	YES	YES		
G63396	S10	ES25	1-3/8"		16.55	10.77	5.78	YES	NO		
G63778	S12	ES25	1-3/8"		24.55	14.52	10.03	YES	NO		
G63716	S12	ES26	1-3/8"		15.54	10.01	5.53	YES	NO		
83317	S16	ES90	1-3/8"	B	27.03	16	11.34	YES	YES		
83301	S16	ES90	1-3/8"	B	24.52	14.74	9.78	YES	YES	653	86
83318	S16	S16	1-3/8"	B	22.53	13.5	9.03	YES	YES	323	77
83613	S16	S16	1-3/8"	A	21.04	12.76	8.28	YES	YES	601	242
85731	S21	EB3	1-5/8"	D	30.57	18.54	12.03	YES	YES	1517	293
85703	S21	EB3	1-5/8"	D	29.57	18.54	11.03	YES	YES	1435	186
85033	S21	EB3	1-5/8"	C	27.21	17.37	9.84	YES	YES	764	254
89427	S21	EB3	1-5/8"	G	27.2	17.5	9.7	YES	YES	794‡	253
85317	S21	EB3	1-5/8"	D	27.18	17.42	9.76	YES	YES	764	254
85711	S21	EB3	1-5/8"	D	24.57	15.29	9.28	YES	YES	1435	208
87000	S21	EB3	2-1/16"	E	24.46	15.21	9.25	YES	YES	1332	300
85311	S21	EB3	1-5/8"	D	23.95	14.79	9.16	YES	YES	764	254
85988	S21	EB3	1-5/8"	G	23.84	14.87	8.97	YES	YES	1200	138
89424	S21	EB3	1-5/8"	G	23.7	15	8.7	YES	YES	794‡	253
85710	S21	EB3	1-5/8"	D	23.45	15.1	8.34	YES	YES	994	248
85343	S21	EB3	1-5/8"	D	22.96	14.79	8.17	YES	YES	858	289
87016	S21	EB3	2-1/16"	E	21.17	13.91	7.26	YES	YES	1808	238
85009	S21	ES36	1-5/8"	C	23.52	14.36	9.16	YES	YES	857	144
83134	S21	ES36	1-3/8"	A	22.24	13.5	8.74	YES	NO	430	49
85921	S21	ES36	1-5/8"	G	22.03	13.5	8.53	YES	NO	2053	339
85316	S21	ES36	1-5/8"	D	20.61	12.85	7.76	YES	NO	943	443
85351	S21	ES36	1-5/8"	D	20.61	12.82	7.79	YES	NO	1887	259
89426	S21	ES36	1-5/8"	G	20.43	12.93	7.5	YES	NO	926‡	419
85056	S21	ES36	1-5/8"	C	20.15	12.87	7.28	YES	YES	732	114
89441	S21	ES36	1-5/8"	G	20.14	13.06	7.08	YES	YES	761‡	126
85935	S21	ES36	1-5/8"	G	18.7	11.92	6.78	YES	NO	1054	419
85319	S21	ES150	1-5/8"	D	22.2	13.92	8.28	YES	YES	988	454
89428	S21	ES150	1-5/8"	G	21.96	14.13	7.83	YES	YES	958‡	446
85709	S21	S21	1-5/8"	D	31.64	18.36	13.28	YES	YES	700	203
85727	S21	S21	1-5/8"	D	29.89	17.36	12.53	YES	YES	783	111
83106	S21	S21	1-3/8"	A	29.25	16.76	12.49	YES	NO	451	80
83136	S21	S21	1-3/8"	A	29.25	16.76	12.49	YES	NO	914	65
85048	S21	S21	1-5/8"	C	29.16	16.88	12.28	YES	NO	432	106
85318	S21	S21	1-5/8"	D	27.37	16.36	11.01	YES	YES	1372	192
85722	S21	S21	1-5/8"	D	27.15	16.43	10.72	YES	YES	1264	369
85069	S21	S21	1-5/8"	C	26.28	15.94	10.34	YES	YES	762	255
89455	S21	S21	1-5/8"	G	26.28	15.92	10.36	YES	YES	791‡	276

* Damping force, in pounds, to either extend or collapse the shock absorber at an average operating velocity. Fuerza de amortiguación en libras para extender o comprimir el amortiguador a una velocidad de operación promedio. La puissance d'amortissement en poids de l'amortisseur, soit comprimé, doit détendu, à une vitesse de fonctionnement moyenne.

† At bumper contact / Al contacto con el tope de goma / Au contact avec le butoir

‡ For GasSLX Series, forces are at the "Firm" (F) setting. / Para la serie GasSLX, las fuerzas están ajustadas en (F) "Firme". / Pour la série GasSLX, le réglage de la force est sur «Firme» (F).

SPECIFICATIONS BY END MOUNT
ESPECIFICACIONES POR TIPO DE MONTAJE
SPÉCIFICATIONS PAR FIXATION DES EXTRÉMITÉS

Fleetline	Mounting		Bore	External Diameter Illustration	Lengths			Dust Tube	Recoil Cutoff	Controls*	
	Upper	Lower			Extended	Collapsed	Stroke			Rebound	Compression
85328	S21	S21	1-5/8"	D	25.64	15.36	10.28	YES	NO	930	383
85071	S21	S21	1-5/8"	C	25.57	15.04	10.53	YES	NO	610	107
85049	S21	S21	1-5/8"	C	25.53	15	10.53	YES	NO	597	107
85085	S21	S21	1-5/8"	C	24.95	14.67	10.23	YES	NO	970	101
85728	S21	S21	1-5/8"	D	24.39	14.86	9.53	YES	YES	1435	510
83456	S21	S21	1-3/8"	B	24.03	14.25	9.78	YES	YES	566	80
85705	S21	S21	1-5/8"	D	23.65	14.24	9.41	YES	YES	639	436
85706	S21	S21	1-5/8"	D	23.65	14.24	9.41	YES	YES	1086	696
85707	S21	S21	2-1/16"	D	23.65	14.4	9.25	YES	YES	1761	986
87011	S21	S21	2-1/16"	E	23.65	14.4	9.25	YES	YES	1750	1050
87012	S21	S21	2-1/16"	E	23.65	14.4	9.25	YES	YES	650	364
87013	S21	S21	2-1/16"	E	23.65	14.4	9.25	YES	YES	1075	585
89447	S21	S21	1-5/8"	G	23.65	14.57	9.08	YES	YES	702‡	241
85325	S21	S21	1-5/8"	D	23.64	14.36	9.28	YES	NO	1024	240
85347	S21	S21	1-5/8"	D	23.62	14.22	9.4	YES	YES	961	122
85342	S21	S21	1-5/8"	D	23.28	13.99	9.29	YES	NO	893	188
83102	S21	S21	1-3/8"	A	22.94	13.56	9.38	YES	YES	513	333
85324	S21	S21	1-5/8"	D	22.14	13.61	8.53	YES	NO	579	114
85346	S21	S21	1-5/8"	D	22.12	13.48	8.64	YES	YES	2016	285
85027	S21	S21	1-5/8"	C	21.52	12.99	8.53	YES	NO	1008	539
89418	S21	S21	1-5/8"	G	21.44	13.19	8.25	YES	NO	1266‡	515
695406	S21	S21	2-1/16"	E	21.39	13.26	8.13	YES	YES	1854	274
85124	S21	S21	1-5/8"	C	20.91	12.9	8.01	YES	YES	1086	222
85708	S21	S21	1-5/8"	D	20.64	12.86	7.78	YES	YES	914	204
85745	S21	S21	1-5/8"	D	19.88	12.34	7.54	YES	YES	3064	231
85746	S21	S21	1-5/8"	D	19.88	12.34	7.54	YES	YES	1754	167
83103	S21	S21	1-3/8"	A	19.64	11.89	7.75	YES	YES	517	301
85326	S21	S21	1-5/8"	D	19.64	12.36	7.28	YES	NO	799	142
85902	S21	S21	1-5/8"	G	19.01	12.03	6.98	YES	YES	1441	267
85336	S21	S21	1-5/8"	D	18.76	11.86	6.9	YES	NO	861	200
85310	S21	S21	1-5/8"	D	18.65	11.74	6.91	YES	YES	1379	578
89423	S21	S21	1-5/8"	G	18.65	12.07	6.58	YES	YES	1352‡	573
85900	S21	S21	1-5/8"	G	17.27	11.16	6.11	YES	YES	1467	337
87007	S21	S21	2-1/16"	E	15.65	10.4	5.25	YES	YES	879	253
85701	S21	S21	1-5/8"	D	15.64	10.36	5.28	YES	YES	914	204
G63500	S28	ES25	1-3/8"		15.09	10.06	5.03	NO	YES		
G63678	S36	BP7	1-3/8"		18.09	13.56	4.53	YES	NO		
G63622	S36	EB1	1-3/8"		15.42	10.39	5.03	YES	YES		
G63614	S36	EB1	1-3/8"		15.12	10.09	5.03	NO	YES		
G63929	S36	EB1	1-3/8"		14.72	9.71	5.01	YES	YES		
G63608	S36	EB1	1-3/8"		14.58	9.81	4.78	YES	YES		
G63386	S36	ES25	1-3/8"		17.19	11.16	6.03	NO	YES		

* Damping force, in pounds, to either extend or collapse the shock absorber at an average operating velocity. Fuerza de amortiguación en libras para extender o comprimir el amortiguador a una velocidad de operación promedio. La puissance d'amortissement en poids de l'amortisseur, soit comprimé, doit détendu, à une vitesse de fonctionnement moyenne.

† At bumper contact / Al contacto con el tope de goma / Au contact avec le butoir

‡ For GasSLX Series, forces are at the "Firm" (F) setting. / Para la serie GasSLX, las fuerzas están ajustadas en (F) "Firme". / Pour la série GasSLX, le réglage de la force est sur «Firme» (F).

SPECIFICATIONS BY END MOUNT
ESPECIFICACIONES POR TIPO DE MONTAJE
SPÉCIFICATIONS PAR FIXATION DES EXTRÉMITÉS

Fleetline	Mounting		Bore	External Diameter Illustration	Lengths			Dust Tube	Recoil Cutoff	Controls*	
	Upper	Lower			Extended	Collapsed	Stroke			Rebound	Compression
G63623	S36	ES83	1-3/8"		22.67	14.39	8.28	YES	YES		
G63624	S36	ES83	1-3/8"		20.17	12.64	7.53	YES	YES		
83178	S38	ES83	1-3/8"	A	21.95	13.26	8.69	YES	NO	690	275
83177	S40	EB1	1-3/8"	A	14.99	10.12	5.38	YES	NO	690	275
83114	S40	ES35	1-3/8"	A	23	13.76	9.24	YES	NO	450	102
83105	S40	ES179	1-3/8"	A	31.91	18.29	13.62	YES	NO	559	150
83162	S40	ES190	1-3/8"	A	24.35	14.69	9.67	YES	NO	877	52
85332	S42	ES36	1-5/8"	D	20.64	12.98	7.66	YES	YES	2351	967
85333	S42	ES36	1-5/8"	D	20.64	12.98	7.66	YES	YES	1241	534

* Damping force, in pounds, to either extend or collapse the shock absorber at an average operating velocity. Fuerza de amortiguación en libras para extender o comprimir el amortiguador a una velocidad de operación promedio. La puissance d'amortissement en poids de l'amortisseur, soit comprimé, doit détendu, à une vitesse de fonctionnement moyenne.

† At bumper contact / Al contacto con el tope de goma / Au contact avec le butoir

‡ For GasSLX Series, forces are at the "Firm" (F) setting. / Para la serie GasSLX, las fuerzas están ajustadas en (F) "Firme". / Pour la série GasSLX, le réglage de la force est sur «Firme» (F).

SPECIFICATIONS BY PART NUMBER
ESPECIFICACIONES POR NÚMERO DE PARTE
SPÉCIFICATIONS PAR NUMÉRO DE PIÈCE

Fleetline	Mounting		Bore	External Diameter Illustration	Lengths			Dust Tube	Recoil Cutoff	Controls*	
	Upper	Lower			Extended	Collapsed	Stroke			Rebound	Compression
83001	ES149	EB1	1-3/8"	A	10.41†	8.36†	3	YES	YES	793	363
83002	ES10	ES10	1-3/8"	A	11.61	8.62	3	YES	YES	3112	590
83003	S1	BP7	1-3/8"	A	11.76	8.95†	3.4	YES	YES	248	100
83004	ES35	ES136	1"	2" D/T	9.36†	7.29	2.32	YES	YES	539	324
83005	BP8	S10	1-3/16"	2" D/T	7.34	5.87	1.47	YES	NO	858	216
83006	ES149	EB1	1-3/8"	A	10.66	8.48†	2.77	YES	YES	525	182
83007	EB1	EB1	1-3/8"	A	18.54	11.67	6.87	NO	NO	489	343
83008	ES136	ES136	1-3/8"	A	12.98†	10.15†	3.99	YES	YES	699	307
83009	ES149	ES149	1-3/8"	A	10.41†	8.36†	2.99	YES	YES	793	363
83010	ES24	ES24	1"	2" D/T	14.15†	9.33	5.07	YES	YES	188	70
83011	EB1	EB1	1-3/8"	A	11.55†	8.43	3.62	YES	YES	738	330
83012	EB1	EB1	1-3/8"	A	11.05†	8.18	3.37	YES	YES	738	330
83013	BP8	BP8	1-3/16"	2" D/T	7.66	6.63†	1.7	YES	NO	646	480
83014	S1	S1	1-3/8"	A	10.48	7.11	3.37	NO	NO	544	501
83015	BP8	S1	1-3/8"	A	9.79	7.55	2.24	YES	YES	735	430
83016	ES10	ES10	1"	1-5/8"	11.51	8.14	3.37	NO	YES	506	139
83017	ES149	ES149	1-3/8"	A	10.93	8.35†	3.13	YES	YES	353	138
83018	ES24	S10	1-3/8"	A	10.3†	8.42†	3.24	YES	YES	515	174
83019	ES24	S10	1-3/8"	A	9.42	8.16†	2.28	YES	YES	509	121
83020	ES91	ES91	1-3/8"	A	9.41	7.17	2.24	YES	YES	796	255
83021	ES10	ES10	1-3/8"	A	9.36	7.37	1.99	YES	YES	745	315
83022	ES24	ES24	1"	2" D/T	14.28	9.33	4.95	YES	NO	840	152
83023	ES10	ES181	1"	1-5/8"	8.7	7.09†	2.14	NO	YES	484	157
83024	ES10	ES10	1-3/8"	2-1/2" D/T	11.61	8.62	2.99	YES	YES	811	320
83025	ES163	ES163	1-3/8"	A	7.98	6.49	1.49	YES	YES	710	230
83026	ES24	ES24	1-3/8"	A	13.11	9.12	3.99	YES	YES	602	104
83027	ES24	S10	1-3/8"	A	13.8	9.18	4.62	YES	YES	602	104
83028	ES86	ES167	1-3/8"	A	9.94	7.57	2.37	YES	YES	445	531
83029	ES168	ES169	1-5/8"	C	10.35	7.94	2.41	YES	NO	1303	1349
83030	ES136	ES136	1-3/8"	A	9.6†	7.61	2.49	YES	YES	308	87
83031	ES10	ES10	1-3/8"	2-1/2" D/T	11.49	8.62	2.87	YES	YES	811	314
83032	ES163	ES163	1-3/8"	A	7.85	6.36	1.49	NO	YES	779	135
83033	ES53	ES53	1-3/8"	A	13.99	10.37	3.62	YES	YES	494	312
83034	ES115	ES115	1-3/16"	1-5/8"	10.04†	7.32	2.97	NO	YES	430	129
83035	ES166	ES136	1-3/8"	A	12.96†	9.33	4.13	YES	YES	320	100
83038	ES149	EB1	1-3/8"	A	10.41†	8.36†	2.99	YES	YES	336	242
83039	ES149	ES149	1-3/8"	A	10.41†	8.36†	2.99	YES	YES	876	326
83040	ES171	ES172	1-3/8"	A	10.41†	8.36†	2.99	YES	YES	876	326
83041	BP27	S10	1-3/8"	A	10.51†	8.34†	3.02	YES	YES	486	189
83042	ES136	ES136	1-3/8"	A	9.88†	8.44†	2.38	YES	YES	954	541
83044	ES27	ES164	1-3/8"	A	10.91	7.93	2.98	YES	YES	789	296
83045	ES19	S10	1-3/8"	A	11.53†	8.58†	3.81	YES	NO	510	153

* Damping force, in pounds, to either extend or collapse the shock absorber at an average operating velocity. Fuerza de amortiguación en libras para extender o comprimir el amortiguador a una velocidad de operación promedio. La puissance d'amortissement en poids de l'amortisseur, soit comprimé, doit détendu, à une vitesse de fonctionnement moyenne.

† At bumper contact / Al contacto con el tope de goma / Au contact avec le butoir

‡ For GasSLX Series, forces are at the "Firm" (F) setting. / Para la serie GasSLX, las fuerzas están ajustadas en (F) "Firme". / Pour la série GasSLX, le réglage de la force est sur «Firme» (F).

SPECIFICATIONS BY PART NUMBER
ESPECIFICACIONES POR NÚMERO DE PARTE
SPÉCIFICATIONS PAR NUMÉRO DE PIÈCE

Fleetline	Mounting		Bore	External Diameter Illustration	Lengths			Dust Tube	Recoil Cutoff	Controls*	
	Upper	Lower			Extended	Collapsed	Stroke			Rebound	Compression
83046	ES10	ES181	1-3/16"		9.23†	7.62†	2.73	NO	YES	514	173
83047	ES149	EB1	1-3/8"	A	11.78†	9.74†	3	YES	YES	364	314
83048	ES86	ES167	1-3/8"	A	9.97	8.43†	2.37	YES	YES	904	415
83049	ES163	ES163	1-3/8"	A	8.02	6.53	1.48	YES	YES	2879	705
83050	ES19	S10	1-3/8"	A	10.43†	8.38†	2.9	YES	YES	599	321
83051	ES10	ES10	1-3/8"	2-1/2" D/T	9.41	7.4	2.01	YES	YES	579	163
83052	ES185	ES185	1-3/8"	2-1/2" D/T	9.41	7.19	2.23	YES	NO	1101	149
83053	ES185	ES185	1-3/8"	A	10.91	7.93	2.97	YES	YES	968	214
83054	ES185	ES185	1-3/8"	A	10.28	7.56	2.72	YES	YES	1004	184
83056	ES136	ES136	1-5/8"	C	11.53	8.63	2.89	YES	YES	3830	737
83057	ES171	ES172	1-3/8"	2-1/2" D/T	10.44†	8.4†	2.99	YES	YES	364	242
83058	ES19	S10	1-3/8"	A	10.43†	8.38†	2.9	YES	YES	742	243
83059	ES35	ES35	1-3/8"	A	12.06†	8.68	3.88	YES	YES	738	350
83060	EB	BP7	1-3/8"	A	9.76	7.98†	2.25	NO	YES	431	441
83061	ES10	ES10	1-3/8"	2-1/2" D/T	9.41	7.4	2.01	YES	YES	1030	220
83062	ES185	S42	1-3/8"	A	12.71	9.18	3.53	YES	NO	704	153
83063	ES175	ES136	1-3/8"	A	10.76†	9.26†	3.01	YES	YES	954	541
83064	ES149	ES149	1-3/8"	A	10.41†	8.36†	2.99	YES	YES	635	323
83065	ES206	ES171	1-5/8"	G	12.52	9.32	3.2	YES	YES	680‡	184
83066	ES153	ES153	1-3/8"	A	11.15†	9.2†	2.78	YES	YES	599	221
83067	ES166	ES136	1-3/16"	2" D/T	12.33†	9.27†	3.56	YES	YES	424	101
83100	ES90	ES90	1-3/8"	A	26.6	16.11	10.49	YES	YES	481	142
83101	ES90	ES90	1-3/8"	A	24.6	15.11	9.49	YES	YES	481	142
83102	S21	S21	1-3/8"	A	22.94	13.56	9.38	YES	YES	513	333
83103	S21	S21	1-3/8"	A	19.64	11.89	7.75	YES	YES	517	301
83104	EB3	EB3	1-3/8"	A	28.24	17.12	11.12	YES	NO	698	133
83105	S40	ES179	1-3/8"	A	31.91	18.29	13.62	YES	NO	559	150
83106	S21	S21	1-3/8"	A	29.25	16.76	12.49	YES	NO	451	80
83107	EB2	EB2	1-3/8"	A	31.6	18.36	13.24	YES	NO	352	77
83109	ES36	S42	1-3/8"	A	26.14	15.9	10.24	YES	YES	345	78
83110	ES36	S42	1-3/8"	A	22.89	14.27	8.62	YES	YES	450	143
83111	ES36	S42	1-3/8"	A	26.14	15.9	10.24	YES	YES	560	141
83112	ES36	S42	1-3/8"	A	21.52	13.4	8.12	YES	YES	1064	343
83113	ES36	EB3	1-3/8"	A	20.42	13.43	6.99	YES	YES	997	238
83114	S40	ES35	1-3/8"	A	23	13.76	9.24	YES	NO	450	102
83115	ES36	EB3	1-3/8"	A	16.19	13.32	4.87	YES	YES	997	238
83116	ES164	ES165	1-3/8"	A	23.81	14.68	9.12	YES	NO	354	300
83117	EB4	EB1	1-3/8"	A	23.94	14.45	9.49	YES	NO	354	300
83118	ES164	ES90	1-3/8"	A	24.45	14.71	9.74	YES	NO	410	311
83119	EB4	ES165	1-3/8"	A	23.96	14.84	9.12	YES	NO	354	300
83120	ES120	S21	1-3/8"	A	22.12	13.63	8.49	YES	YES	779	164
83121	ES36	ES36	1-3/8"	A	30.25	18.32	11.93	YES	YES	689	126

* Damping force, in pounds, to either extend or collapse the shock absorber at an average operating velocity. Fuerza de amortiguación en libras para extender o comprimir el amortiguador a una velocidad de operación promedio. La puissance d'amortissement en poids de l'amortisseur, soit comprimé, doit détendu, à une vitesse de fonctionnement moyenne.

† At bumper contact / Al contacto con el tope de goma / Au contact avec le butoir

‡ For GasSLX Series, forces are at the "Firm" (F) setting. / Para la serie GasSLX, las fuerzas están ajustadas en (F) "Firme". / Pour la série GasSLX, le réglage de la force est sur «Ferme» (F).

SPECIFICATIONS BY PART NUMBER
ESPECIFICACIONES POR NÚMERO DE PARTE
SPÉCIFICATIONS PAR NUMÉRO DE PIÈCE

Fleetline	Mounting		Bore	External Diameter Illustration	Lengths			Dust Tube	Recoil Cutoff	Controls*	
	Upper	Lower			Extended	Collapsed	Stroke			Rebound	Compression
83122	ES36	ES36	1-3/8"	A	25.24	15.75	9.49	YES	YES	661	201
83123	ES36	ES36	1-3/8"	A	26.62	16.38	10.24	YES	YES	589	119
83124	ES36	ES36	1-3/8"	A	21.65	13.75	7.87	YES	YES	750	137
83125	ES36	ES36	1-3/8"	A	28.12	17.13	10.99	YES	YES	625	115
83126	ES36	ES36	1-3/8"	A	24.37	15.25	9.12	YES	YES	625	115
83127	ES36	ES36	1-3/8"	A	20.12	13.13	6.99	YES	YES	940	218
83128	ES36	ES36	1-3/8"	A	16.87	11.51	5.37	YES	YES	940	218
83130	ES36	ES36	1-3/8"	A	18.03	12.04	5.99	YES	YES	871	177
83131	ES83	ES83	1-3/8"	A	27.8	18.18	9.62	YES	NO	212	129
83132	EB3	EB3	1-3/8"	A	25.24	15.5	9.74	YES	NO	828	150
83134	S21	ES36	1-3/8"	A	22.24	13.5	8.74	YES	NO	430	49
83135	ES90	ES90	1-3/8"	A	19.48	12.36	7.12	YES	NO	519	121
83136	S21	S21	1-3/8"	A	29.25	16.76	12.49	YES	NO	914	65
83137	ES36	ES36	1-3/8"	A	30.03	17.78	12.25	YES	YES	517	132
83138	ES36	S42	1-3/8"	A	23.55	14.42	9.12	YES	YES	997	231
83140	EB3	EB3	1-3/8"	A	25.27	15.52	9.75	YES	NO	738	88
83141	EB3	EB3	1-3/8"	A	25.27	15.52	9.75	YES	NO	408	113
83142	ES162	S42	1-3/8"	A	23.92	14.5	9.43	YES	YES	367	131
83143	ES162	S42	1-3/8"	A	21.92	13.5	8.43	YES	YES	403	137
83144	ES36	ES36	1-3/8"	A	23.78	15.03	8.75	YES	YES	596	93
83145	ES83	ES83	1-3/8"	A	19.93	12.32	7.54	YES	NO	479	153
83146	ES90	ES83	1-3/8"	A	24.02	14.68	9.33	YES	YES	479	119
83147	ES179	ES179	1-3/8"	A	28.53	17.34	11.15	YES	YES	358	128
83148	ES179	ES179	1-3/8"	A	30	17.83	12.17	YES	YES	604	149
83149	ES36	ES36	1-3/8"	A	25.28	15.78	9.49	YES	YES	332	101
83150	ES36	ES36	1-3/8"	A	15.24	10.43	4.81	YES	YES	940	216
83153	ES34	ES34	1-3/8"	A	21.69	13.62	8.07	YES	YES	974	206
83154	ES120	S21	1-3/8"	A	20.78	12.72	8.06	YES	YES	599	140
83155	ES34	ES34	1-3/8"	A	21.69	13.62	8.07	YES	YES	507	80
83156	ES90	ES90	1-3/8"	A	18.55	11.91	6.64	YES	NO	778	135
83157	ES36	ES90	1-3/8"	A	26.38	15.76	10.61	YES	NO	446	303
83158	ES22	ES22	1-3/8"	A	12.96	8.97	4	YES	NO	783	484
83159	EB2	EB2	1-3/8"	A	21.62	13.4	8.14	YES	NO	658	149
83160	ES128	ES36	1-3/8"	A	24.31	14.9	9.37	YES	YES	920	161
83161	S1	EB1	1-3/8"	A	20.82	12.56	8.25	YES	NO	400	70
83162	S40	ES190	1-3/8"	A	24.35	14.69	9.67	YES	NO	877	52
83163	ES175	ES175	1-3/8"	A	20.75	13.01	7.74	YES	NO	828	98
83164	ES36	ES165	1-3/8"	C	24.22	14.59	9.63	YES	NO	426	274
83166	ES179	ES179	1-3/8"	A	25.28	15.78	9.49	YES	YES	622	132
83167	ES90	ES90	1-3/8"	A	19.49	12.38	7.11	YES	NO	285	90
83168	ES179	ES179	1-3/8"	A	25.28	15.78	9.49	YES	YES	246	88
83169	ES90	ES90	1-3/8"	A	18.55	11.91	6.64	YES	NO	599	171

* Damping force, in pounds, to either extend or collapse the shock absorber at an average operating velocity. Fuerza de amortiguación en libras para extender o comprimir el amortiguador a una velocidad de operación promedio. La puissance d'amortissement en poids de l'amortisseur, soit comprimé, doit détendu, à une vitesse de fonctionnement moyenne.

† At bumper contact / Al contacto con el tope de goma / Au contact avec le butoir

‡ For GasSLX Series, forces are at the "Firm" (F) setting. / Para la serie GasSLX, las fuerzas están ajustadas en (F) "Firme". / Pour la série GasSLX, le réglage de la force est sur «Firme» (F).

SPECIFICATIONS BY PART NUMBER
ESPECIFICACIONES POR NÚMERO DE PARTE
SPÉCIFICATIONS PAR NUMÉRO DE PIÈCE

Fleetline	Mounting		Bore	External Diameter Illustration	Lengths			Dust Tube	Recoil Cutoff	Controls*	
	Upper	Lower			Extended	Collapsed	Stroke			Rebound	Compression
83171		ES36	1-3/8"	A	23.98	14.51	9.47	YES	YES	513	146
83174	ES128	ES36	1-3/8"	A	24.31	14.9	9.37	YES	YES	795	160
83175	ES175	ES175	1-3/8"	A	20.48	13.19	7.29	YES	NO	1245	156
83176	ES36	ES36	1-3/8"	A	26.62	15.96	10.66	NO	NO	406	275
83177	S40	EB1	1-3/8"	A	14.99	10.12	5.38	YES	NO	690	275
83178	S38	ES83	1-3/8"	A	21.95	13.26	8.69	YES	NO	690	275
83180	ES90	ES83	1-3/8"		30.2	21.24	8.96	YES	NO	909	204
83200	EB2	EB2	1-3/8"	A	24.51	15.1	9.53	YES	NO	806	370
83203	ES36	ES36	1-3/8"	A	17.1	11.36	5.74	YES	YES	609	114
83204	ES36	ES36	1-3/8"	A	20.14	12.86	7.28	YES	YES	451	110
83205	ES36	ES36	1-3/8"	A	29.69	17.69	12	YES	YES	660	76
83207	ES36	ES36	1-3/8"	A	21.64	13.61	8.03	YES	YES	553	143
83209	ES36	ES36	1-3/8"	A	29.64	17.61	12.03	YES	YES	670	78
83214	EB3	EB3	1-3/8"	A	19.64	12.86	6.78	YES	YES	269	90
83215	EB3	EB3	1-3/8"	A	26.64	16.36	10.28	YES	YES	697	108
83216	EB2	EB2	1-3/8"	A	23.51	14.48	9.03	YES	YES	776	262
83217	EB3	EB3	1-3/8"	A	22.77	14.49	8.28	YES	YES	539	202
83218	ES36	ES36	1-3/8"	A	25.19	15.44	9.75	YES	YES	721	194
83219	EB2	EB2	1-3/8"	A	20.01	12.73	7.28	YES	YES	299	125
83221	ES36	ES36	1-3/8"	A	24.01	14.73	9.28	YES	YES	599	153
83225	EB3	EB3	1-3/8"	A	24.14	15.11	9.03	YES	YES	482	159
83242	ES36	ES36	1-3/8"	A	33.73	20.98	12.75	YES	YES	721	135
83301	S16	ES90	1-3/8"	B	24.52	14.74	9.78	YES	YES	653	86
83303	EB7	ES36	1-3/8"	B	24.86	15.08	9.78	YES	YES	470	122
83304	EB7	ES36	1-3/8"	B	22.86	14.08	8.78	YES	YES	470	122
83308	EB2	EB2	1-3/8"	B	25.14	15.36	9.78	YES	YES	445	180
83309	EB2	EB2	1-3/8"	B	28.64	17.11	11.53	YES	YES	589	135
83310	ES36	ES36	1-3/8"	B	24.06	14.69	9.37	YES	NO	559	153
83312	EB2	EB2	1-3/8"	B	26.64	16.11	10.53	YES	YES	527	152
83314	EB2	EB2	1-3/8"	B	30.64	18.11	12.53	YES	YES	633	143
83317	S16	ES90	1-3/8"	B	27.03	16	11.34	YES	YES		
83318	S16	S16	1-3/8"	B	22.53	13.5	9.03	YES	YES	323	77
83353	EB3	S21	1-3/8"	B	24.84	15.06	9.78	YES	NO	432	214
83362	EB3	EB3	1-3/8"	B	27	16.25	10.75	YES	NO	539	202
83389	ES36	ES36	1-3/8"	A	17.32	11.57	5.75	YES	YES	1084	228
83400	S1	S1	1-3/16"	F	22.02	12.82	9.2	YES	NO	301	120
83401	EB1	EB1	1-3/16"	F	24.09	14.26	9.83	YES	NO	341	252
83404	EB2	EB2	1-3/16"	F	22.01	13.44	8.58	YES	NO	545	171
83456	S21	S21	1-3/8"	B	24.03	14.25	9.78	YES	YES	566	80
83515	S1	EB2	1-3/16"		23.34	13.89	9.45	YES	NO	643	205
83518	S1	EB2	1-3/16"		24.4	14.26	10.14	YES	NO	153	82
83519	EB2	EB2	1-3/16"		23.83	14.35	9.48	YES	NO	292	132

* Damping force, in pounds, to either extend or collapse the shock absorber at an average operating velocity. Fuerza de amortiguación en libras para extender o comprimir el amortiguador a una velocidad de operación promedio. La puissance d'amortissement en poids de l'amortisseur, soit comprimé, doit détendu, à une vitesse de fonctionnement moyenne.

† At bumper contact / Al contacto con el tope de goma / Au contact avec le butoir

‡ For GasSLX Series, forces are at the "Firm" (F) setting. / Para la serie GasSLX, las fuerzas están ajustadas en (F) "Firme". / Pour la série GasSLX, le réglage de la force est sur «Firme» (F).

SPECIFICATIONS BY PART NUMBER
ESPECIFICACIONES POR NÚMERO DE PARTE
SPÉCIFICATIONS PAR NUMÉRO DE PIÈCE

Fleetline	Mounting		Bore	External Diameter Illustration	Lengths			Dust Tube	Recoil Cutoff	Controls*	
	Upper	Lower			Extended	Collapsed	Stroke			Rebound	Compression
83613	S16	S16	1-3/8"	A	21.04	12.76	8.28	YES	YES	601	242
83634	ES120	ES120	1-3/8"	A	27.48	16.23	11.25	YES	YES	779	157
83635	ES36	S21	1-3/8"	A	21.74	13.25	8.49	YES	NO	558	119
83636	ES90	ES90	1-3/8"	A	27.72	16.95	10.77	YES	YES	505	148
85000	ES36	ES36	1-5/8"	C	17.22	11.46	5.76	YES	YES	1019	219
85001	EB3	EB3	1-5/8"	C	26.27	16.36	9.91	YES	NO	1202	186
85003	ES90	ES90	1-5/8"	C	25.37	15.59	9.78	YES	YES	437	182
85004	EB3	EB3	1-5/8"	C	20.68	13.67	7.01	YES	YES	1019	219
85005	ES36	ES36	1-5/8"	C	24.74	15.21	9.53	YES	YES	1019	219
85006	ES36	ES36	1-5/8"	C	28.5	17.09	11.41	YES	YES	1019	219
85007	EB3	EB3	1-5/8"	C	24.21	15.3	8.91	YES	YES	1008	171
85009	S21	ES36	1-5/8"	C	23.52	14.36	9.16	YES	YES	857	144
85010	ES36	ES36	1-5/8"	C	26.74	16.21	10.53	YES	YES	1019	219
85011	ES120	ES121	1-5/8"	C	27.49	16.46	11.03	YES	NO	1268	186
85012	EB2	EB2	1-5/8"	C	21	13.22	7.78	YES	NO	523	199
85013	ES36	ES36	1-5/8"	C	29.74	17.71	12.03	YES	YES	1019	219
85014	ES36	ES36	1-5/8"	C	21.74	13.71	8.03	YES	YES	1019	219
85023	EB2	EB2	1-5/8"	C	20.24	12.96	7.28	YES	YES	1008	539
85024	EB2	EB2	1-5/8"	C	28.74	17.21	11.53	YES	YES	1008	539
85025	EB2	S21	1-5/8"	C	23	13.97	9.03	YES	NO	1079	539
85026	ES136	S21	1-5/8"	C	23	13.97	9.03	YES	NO	1079	539
85027	S21	S21	1-5/8"	C	21.52	12.99	8.53	YES	NO	1008	539
85029	ES36	ES36	1-5/8"	C	20.5	13.09	7.41	YES	YES	1019	219
85030	ES36	ES36	1-5/8"	C	24	14.84	9.16	YES	YES	1019	219
85031	ES176	EB2	1-5/8"	C	25.63	15.85	9.78	YES	NO	941	257
85033	S21	EB3	1-5/8"	C	27.21	17.37	9.84	YES	YES	764	254
85036	ES36	ES36	1-5/8"	C	26.38	16.29	10.09	YES	YES	633	119
85040	EB3	EB3	1-5/8"	C	30.9	18.49	12.41	YES	NO	889	114
85042	EB3	EB3	1-5/8"	C	20.64	13.61	7.03	YES	YES	333	161
85043	ES36	ES36	1-5/8"	C	27.63	16.85	10.78	YES	YES	628	163
85044	ES36	ES36	1-5/8"	C	22.63	14.1	8.53	YES	NO	722	212
85045	ES36	ES36	1-5/8"	C	14.51	10.1	4.41	YES	YES	1020	219
85046	EB2	EB2	1-5/8"	C	27.51	16.6	10.91	YES	YES	1008	539
85047	EB2	EB2	1-5/8"	C	25.25	15.47	9.78	YES	YES	1008	539
85048	S21	S21	1-5/8"	C	29.16	16.88	12.28	YES	NO	432	106
85049	S21	S21	1-5/8"	C	25.53	15	10.53	YES	NO	597	107
85050	ES36	ES36	1-5/8"	C	23.28	14.5	9.03	YES	NO	525	138
85051	ES36	ES36	1-5/8"	C	18.53	12.15	6.4	YES	YES	1019	139
85052	ES36	ES36	1-5/8"	C	13.25	9.47	3.78	YES	YES	1019	139
85053	EB3	EB3	1-5/8"	C	24.65	15.49	9.16	YES	NO	1019	227
85054	EB2	EB2	1-5/8"	C	23.26	14.35	8.91	YES	NO	602	104
85055	EB2	EB2	1-5/8"	C	25.63	15.6	10.03	YES	NO	577	102

* Damping force, in pounds, to either extend or collapse the shock absorber at an average operating velocity. Fuerza de amortiguación en libras para extender o comprimir el amortiguador a una velocidad de operación promedio. La puissance d'amortissement en poids de l'amortisseur, soit comprimé, doit détendu, à une vitesse de fonctionnement moyenne.

† At bumper contact / Al contacto con el tope de goma / Au contact avec le butoir

‡ For GasSLX Series, forces are at the "Firm" (F) setting. / Para la serie GasSLX, las fuerzas están ajustadas en (F) "Firme". / Pour la série GasSLX, le réglage de la force est sur «Firme» (F).

SPECIFICATIONS BY PART NUMBER
ESPECIFICACIONES POR NÚMERO DE PARTE
SPÉCIFICATIONS PAR NUMÉRO DE PIÈCE

Fleetline	Mounting		Bore	External Diameter Illustration	Lengths			Dust Tube	Recoil Cutoff	Controls*	
	Upper	Lower			Extended	Collapsed	Stroke			Rebound	Compression
85056	S21	ES36	1-5/8"	C	20.15	12.87	7.28	YES	YES	732	114
85057	ES36	EB3	1-5/8"	C	21.45	14.23	7.22	YES	YES	1216	115
85058	ES36	ES36	1-5/8"	C	22.63	14.22	8.41	YES	YES	722	114
85059	ES36	EB3	1-5/8"	C	19.07	12.79	6.28	YES	YES	928	151
85060	ES36	ES36	1-5/8"	C	19.75	12.72	7.03	YES	YES	943	405
85061	ES161	ES162	1-5/8"	C	24.75	15.22	9.53	YES	YES	1216	195
85062	EB2	EB2	1-5/8"	C	19.76	12.6	7.2	YES	NO	523	199
85063	EB2	EB2	1-5/8"	C	32.01	18.85	13.16	YES	NO	762	174
85064	ES36	ES36	1-5/8"	C	16.03	10.76	5.27	YES	YES	1481	340
85065	ES161	S21	1-5/8"	C	28.02	16.99	11.03	YES	YES	1059	300
85066	ES161	ES162	1-5/8"	C	24.63	15.22	9.41	YES	YES	812	322
85067	ES174	ES136	1-5/8"	C	30.51	18.1	12.41	YES	YES	676	170
85069	S21	S21	1-5/8"	C	26.28	15.94	10.34	YES	YES	762	255
85070	ES174	EB3	1-5/8"	C	25.6	15.82	9.78	YES	NO	1100	310
85071	S21	S21	1-5/8"	C	25.57	15.04	10.53	YES	NO	610	107
85072	ES36	ES176	1-5/8"	C	24.17	14.83	9.34	YES	YES	1387	305
85078	ES36	ES36	1-5/8"	C	14.77	10.13	4.64	YES	YES	1409	282
85079	ES36	ES36	1-5/8"	C	12.04	8.87	3.17	YES	YES	1494	325
85080	ES175	S21	1-5/8"	C	22.51	13.78	8.74	YES	NO	447	138
85081	ES175	S21	1-5/8"	C	23.44	14.33	9.11	YES	YES	1658	250
85082	ES90	ES90	1-5/8"	C	28.6	20.64	7.97	YES	YES	1435	266
85083	ES162	S42	1-5/8"	C	27.81	16.53	11.28	YES	YES	1429	184
85084	ES174	ES136	1-5/8"	C	20.59	13.03	7.57	YES	NO	1145	407
85085	S21	S21	1-5/8"	C	24.95	14.67	10.23	YES	NO	970	101
85086	ES36	ES36	1-5/8"	C	17.55	11.63	5.92	YES	YES	2027	389
85087	ES36	ES176	1-5/8"	C	22.79	14.71	8.08	YES	YES	1568	403
85088	ES161	ES162	1-5/8"	C	25.31	15.52	9.78	YES	YES	616	178
85090	ES150	ES36	1-5/8"	C	25.31	15.52	9.78	YES	YES	943	99
85091	ES36	ES36	1-5/8"	C	21.38	13.56	7.82	YES	NO	1121	331
85092	ES150	S21	1-5/8"	C	21.95	15.04	6.89	YES	YES	1597	138
85097	ES36	ES36	1-5/8"	C	27.95	17.11	10.84	YES	YES	1086	109
85098	ES161	ES162	1-5/8"	C	24.64	15.25	9.39	YES	YES	747	158
85099	ES36	ES36	1-5/8"	C	26.02	15.93	10.09	YES	YES	1152	135
85102	ES36	ES136	1-5/8"	C	21.53	14.94	6.59	YES	YES	1224	342
85106	ES150	ES150	1-5/8"	C	20.03	12.89	7.14	YES	YES	1054	109
85109	ES36	ES195	1-5/8"	C	24.21	15.14	9.07	YES	YES	1123	149
85119	ES150	ES150	1-5/8"	C	21.39	13.81	7.68	YES	YES	1387	185
85120	ES175	ES175	1-5/8"	C	23.67	15.06	8.61	YES	NO	2083	519
85122	ES120	S21	1-5/8"	C	22.22	13.78	8.44	YES	YES	926	162
85123	ES120	S21	1-5/8"	C	21.49	13.26	8.23	YES	NO	1809	246
85124	S21	S21	1-5/8"	C	20.91	12.9	8.01	YES	YES	1086	222
85125	ES158	ES159	1-5/8"	C	26.9	16.64	10.26	YES	YES	1479	183

* Damping force, in pounds, to either extend or collapse the shock absorber at an average operating velocity. Fuerza de amortiguación en libras para extender o comprimir el amortiguador a una velocidad de operación promedio. La puissance d'amortissement en poids de l'amortisseur, soit comprimé, doit détendu, à une vitesse de fonctionnement moyenne.

† At bumper contact / Al contacto con el tope de goma / Au contact avec le butoir

‡ For GasSLX Series, forces are at the "Firm" (F) setting. / Para la serie GasSLX, las fuerzas están ajustadas en (F) "Firme". / Pour la série GasSLX, le réglage de la force est sur «Firme» (F).

SPECIFICATIONS BY PART NUMBER
ESPECIFICACIONES POR NÚMERO DE PARTE
SPÉCIFICATIONS PAR NUMÉRO DE PIÈCE

Fleetline	Mounting		Bore	External Diameter Illustration	Lengths			Dust Tube	Recoil Cutoff	Controls*	
	Upper	Lower			Extended	Collapsed	Stroke			Rebound	Compression
85126	ES158	S21	1-5/8"	C	21.76	13.63	8.13	YES	YES	1086	215
85180	ES150	ES36	1-5/8"	C	20.94	13.83	7.11	YES	YES	681	283
85181	ES150	ES150	1-5/8"	C	26.33	17.06	9.27	YES	YES	681	285
85300	EB3	EB3	1-5/8"	D	18	12.22	5.78	YES	YES	1435	676
85301	EB3	EB3	1-5/8"	D	31.92	19.03	12.89	YES	NO	1442	455
85302	EB3	EB3	1-5/8"	D	22.75	14.66	8.09	YES	NO	836	253
85303	EB3	EB3	1-5/8"	D	24.75	15.47	9.28	YES	NO	1019	221
85304	EB3	EB3	1-5/8"	D	22.25	14.22	8.03	YES	NO	767	325
85305	EB3	EB3	1-5/8"	D	27.25	16.72	10.53	YES	NO	1120	225
85307	EB3	EB3	1-5/8"	D	24.01	15.1	8.91	YES	NO	1094	173
85308	EB3	EB3	1-5/8"	D	25.13	15.85	9.28	YES	YES	764	254
85310	S21	S21	1-5/8"	D	18.65	11.74	6.91	YES	YES	1379	578
85311	S21	EB3	1-5/8"	D	23.95	14.79	9.16	YES	YES	764	254
85312	EB3	S21	1-5/8"	D	23.69	14.85	8.84	YES	YES	717	111
85313	EB3	EB3	1-5/8"	D	26.26	16.35	9.91	YES	YES	717	111
85314	EB3	EB3	1-5/8"	D	26.5	16.47	10.03	YES	YES	1216	169
85315	EB3	EB3	1-5/8"	D	29.66	18.15	11.51	YES	NO	380	142
85316	S21	ES36	1-5/8"	D	20.61	12.85	7.76	YES	NO	943	443
85317	S21	EB3	1-5/8"	D	27.18	17.42	9.76	YES	YES	764	254
85318	S21	S21	1-5/8"	D	27.37	16.36	11.01	YES	YES	1372	192
85319	S21	ES150	1-5/8"	D	22.2	13.92	8.28	YES	YES	988	454
85320	EB3	EB3	1-5/8"	D	26.13	16.35	9.78	YES	NO	970	308
85321	ES36	ES36	1-5/8"	D	25.36	15.58	9.78	YES	YES	1435	676
85322	EB3	ES160	1-5/8"	D	15.26	11.85	3.41	YES	YES	764	162
85323	ES36	ES36	1-5/8"	D	17.36	11.58	5.78	YES	YES	1085	163
85324	S21	S21	1-5/8"	D	22.14	13.61	8.53	YES	NO	579	114
85325	S21	S21	1-5/8"	D	23.64	14.36	9.28	YES	NO	1024	240
85326	S21	S21	1-5/8"	D	19.64	12.36	7.28	YES	NO	799	142
85327	EB3	ES160	1-5/8"	D	16.01	12.1	3.91	YES	YES	764	162
85328	S21	S21	1-5/8"	D	25.64	15.36	10.28	YES	NO	930	383
85329	EB3	EB3	1-5/8"	D	24.5	15.47	9.03	YES	YES	1550	232
85330	EB3	S21	1-5/8"	D	22.44	14.16	8.28	YES	YES	1140	176
85331	ES158	ES159	1-5/8"	D	19.66	12.88	6.78	YES	YES	1757	396
85332	S42	ES36	1-5/8"	D	20.64	12.98	7.66	YES	YES	2351	967
85333	S42	ES36	1-5/8"	D	20.64	12.98	7.66	YES	YES	1241	534
85334	EB3	EB3	1-5/8"	D	14.5	10.47	4.03	YES	YES	1271	319
85335	ES158	ES159	1-5/8"	D	19.66	12.88	6.78	YES	YES	827	107
85336	S21	S21	1-5/8"	D	18.76	11.86	6.9	YES	NO	861	200
85337	ES36	ES36	1-5/8"	D	28.72	17.45	11.28	YES	YES	1318	374
85338	ES36	ES36	1-5/8"	D	19.47	12.7	6.77	YES	YES	1664	420
85339	EB3	EB3	1-5/8"	D	31.68	19.02	12.66	YES	YES	804	463
85340	ES188	S21	1-5/8"	D	26.46	15.85	10.61	YES	YES	1807	165

* Damping force, in pounds, to either extend or collapse the shock absorber at an average operating velocity. Fuerza de amortiguación en libras para extender o comprimir el amortiguador a una velocidad de operación promedio. La puissance d'amortissement en poids de l'amortisseur, soit comprimé, doit détendu, à une vitesse de fonctionnement moyenne.

† At bumper contact / Al contacto con el tope de goma / Au contact avec le butoir

‡ For GasSLX Series, forces are at the "Firm" (F) setting. / Para la serie GasSLX, las fuerzas están ajustadas en (F) "Firme". / Pour la série GasSLX, le réglage de la force est sur «Firme» (F).

SPECIFICATIONS BY PART NUMBER
ESPECIFICACIONES POR NÚMERO DE PARTE
SPÉCIFICATIONS PAR NUMÉRO DE PIÈCE

Fleetline	Mounting		Bore	External Diameter Illustration	Lengths			Dust Tube	Recoil Cutoff	Controls*	
	Upper	Lower			Extended	Collapsed	Stroke			Rebound	Compression
85341	ES188	S21	1-5/8"	D	30.95	18.1	12.85	YES	YES	1807	333
85342	S21	S21	1-5/8"	D	23.28	13.99	9.29	YES	NO	893	188
85343	S21	EB3	1-5/8"	D	22.96	14.79	8.17	YES	YES	858	289
85344	ES36	ES36	1-5/8"	D	13.22	9.45	3.77	YES	YES	1581	443
85345	ES36	ES36	1-5/8"	D	21.83	13.82	8.01	YES	YES	1093	219
85346	S21	S21	1-5/8"	D	22.12	13.48	8.64	YES	YES	2016	285
85347	S21	S21	1-5/8"	D	23.62	14.22	9.4	YES	YES	961	122
85351	S21	ES36	1-5/8"	D	20.61	12.82	7.79	YES	NO	1887	259
85376	EB3	EB3	1-5/8"	D	33.25	19.72	13.53	YES	NO	668	134
85377	ES182	ES182	1-5/8"	D	23.8	14.84	8.96	YES	YES	1937	570
85378	ES182	ES182	1-5/8"	D	23.8	14.84	8.96	YES	YES	1110	240
85379	EB3	S21	1-5/8"	D	22.69	14.4	8.29	YES	YES	1658	176
85380	EB3	S21	1-5/8"	D	23.95	14.79	9.15	YES	YES	1568	227
85382	ES36	ES36	1-5/8"	D	20.22	13.07	7.15	YES	YES	1658	420
85700	EB3	EB3	1-5/8"	D	26.13	16.6	9.53	YES	YES	1446	328
85701	S21	S21	1-5/8"	D	15.64	10.36	5.28	YES	YES	914	204
85702	EB3	EB3	1-5/8"	D	23.76	15.85	7.91	YES	YES	1093	825
85703	S21	EB3	1-5/8"	D	29.57	18.54	11.03	YES	YES	1435	186
85704	EB3	EB3	1-5/8"	D	28.75	18.72	10.03	YES	YES	1435	186
85705	S21	S21	1-5/8"	D	23.65	14.24	9.41	YES	YES	639	436
85706	S21	S21	1-5/8"	D	23.65	14.24	9.41	YES	YES	1086	696
85707	S21	S21	2-1/16"	D	23.65	14.4	9.25	YES	YES	1761	986
85708	S21	S21	1-5/8"	D	20.64	12.86	7.78	YES	YES	914	204
85709	S21	S21	1-5/8"	D	31.64	18.36	13.28	YES	YES	700	203
85710	S21	EB3	1-5/8"	D	23.45	15.1	8.34	YES	YES	994	248
85711	S21	EB3	1-5/8"	D	24.57	15.29	9.28	YES	YES	1435	208
85712	EB3	EB3	1-5/8"	D	20.5	13.47	7.03	YES	YES	1435	562
85713	EB3	EB3	1-5/8"	D	24.5	15.47	9.03	YES	YES	1157	180
85714	EB3	EB3	1-5/8"	D	25.13	15.85	9.28	YES	YES	1220	175
85715	EB3	EB3	1-5/8"	D	25.13	15.85	9.28	YES	YES	1915	200
85716	EB3	EB3	1-5/8"	D	22.01	14.35	7.66	YES	YES	1220	175
85717	EB3	EB3	1-5/8"	D	25.13	15.85	9.28	YES	YES	1915	200
85718	EB3	EB3	1-5/8"	D	22.13	15.04	7.09	YES	YES	2506	206
85719	EB3	EB3	1-5/8"	D	17.25	11.97	5.28	YES	YES	1517	213
85720	EB3	EB3	1-5/8"	D	20.5	13.47	7.03	YES	YES	1435	562
85722	S21	S21	1-5/8"	D	27.15	16.43	10.72	YES	YES	1264	369
85723	EB3	S21	1-5/8"	D	19.94	12.91	7.03	YES	YES	1318	248
85724	ES158	ES159	1-5/8"	D	22.78	14.5	8.28	YES	YES	1235	454
85727	S21	S21	1-5/8"	D	29.89	17.36	12.53	YES	YES	783	111
85728	S21	S21	1-5/8"	D	24.39	14.86	9.53	YES	YES	1435	510
85729	EB3	S21	1-5/8"	D	21.58	13.8	7.78	YES	YES	783	111
85730	EB3	EB3	1-5/8"	D	30.75	18.72	12.03	YES	YES	1517	293

* Damping force, in pounds, to either extend or collapse the shock absorber at an average operating velocity. Fuerza de amortiguación en libras para extender o comprimir el amortiguador a una velocidad de operación promedio. La puissance d'amortissement en poids de l'amortisseur, soit comprimé, doit détendu, à une vitesse de fonctionnement moyenne.

† At bumper contact / Al contacto con el tope de goma / Au contact avec le butoir

‡ For GasSLX Series, forces are at the "Firm" (F) setting. / Para la serie GasSLX, las fuerzas están ajustadas en (F) "Firme". / Pour la série GasSLX, le réglage de la force est sur «Firme» (F).

SPECIFICATIONS BY PART NUMBER
ESPECIFICACIONES POR NÚMERO DE PARTE
SPÉCIFICATIONS PAR NUMÉRO DE PIÈCE

Fleetline	Mounting		Bore	External Diameter Illustration	Lengths			Dust Tube	Recoil Cutoff	Controls*	
	Upper	Lower			Extended	Collapsed	Stroke			Rebound	Compression
85731	S21	EB3	1-5/8"	D	30.57	18.54	12.03	YES	YES	1517	293
85732	EB3	EB3	2-1/16"	E	22.13	15.11	7.03	YES	YES	2632	382
85733	EB3	S21	1-5/8"	D	23.57	14.73	8.84	YES	YES	717	111
85734	EB3	EB3	1-5/8"	D	20.74	13.71	7.03	YES	YES	1288	227
85735	EB3	EB3	1-5/8"	D	26.74	16.71	10.03	YES	YES	1288	227
85736	EB3	EB3	1-5/8"	D	23.62	15.21	8.41	YES	YES	1155	352
85737	ES173	ES173	1-5/8"	D	15.11	10.84	4.27	YES	YES	3066	782
85738	ES36	ES36	1-5/8"	D	17.47	11.7	5.77	YES	YES	1830	416
85739	ES187	ES187	1-5/8"	D	20.73	13.54	7.19	YES	YES	3247	334
85740	EB3	S21	1-5/8"	D	24.7	15.15	9.55	YES	YES	848	305
85745	S21	S21	1-5/8"	D	19.88	12.34	7.54	YES	YES	3064	231
85746	S21	S21	1-5/8"	D	19.88	12.34	7.54	YES	YES	1754	167
85900	S21	S21	1-5/8"	G	17.27	11.16	6.11	YES	YES	1467	337
85901	EB3	EB3	1-5/8"	G	29.05	17.64	11.41	YES	NO	1830	418
85902	S21	S21	1-5/8"	G	19.01	12.03	6.98	YES	YES	1441	267
85903	ES36	ES36	1-5/8"	G	31.99	19.13	12.86	YES	YES	666	113
85904	ES36	ES36	1-5/8"	G	27.61	16.88	10.73	YES	YES	666	113
85905	ES36	EB3	1-5/8"	G	23.81	16.16	7.66	YES	YES	1020	219
85906	ES36	ES36	1-5/8"	G	21.73	14	7.73	YES	YES	700	255
85907	ES36	EB3	1-5/8"	G	21.43	14.2	7.23	YES	YES	1216	251
85908	ES36	ES36	1-5/8"	G	18.48	12.25	6.23	YES	YES	1020	219
85909	ES36	ES36	1-5/8"	G	24.24	15.13	9.11	YES	YES	700	255
85910	ES36	ES36	1-5/8"	G	20.73	13.5	7.23	YES	YES	1074	219
85911	ES36	ES36	1-5/8"	G	16.86	11.5	5.36	YES	YES	1020	219
85912	EB3	ES36	1-5/8"	G	18.68	12.57	6.11	YES	YES	1020	219
85913	ES36	EB3	1-5/8"	G	22.56	15.2	7.36	YES	YES	1020	219
85914	ES36	ES36	1-5/8"	G	14.36	10.25	4.11	YES	YES	1020	219
85915	ES36	EB3	1-5/8"	G	19.06	12.7	6.36	YES	YES	1020	219
85916	ES36	ES36	1-5/8"	G	24.61	15.51	9.11	YES	YES	1149	219
85918	ES150	ES150	1-5/8"	G	22.96	14.55	8.41	YES	NO	1726	412
85919	ES36	ES36	1-5/8"	G	22.48	14.25	8.23	YES	YES	1265	121
85920	ES150	ES150	1-5/8"	G	21.19	13.53	7.66	YES	NO	845	49
85921	S21	ES36	1-5/8"	G	22.03	13.5	8.53	YES	NO	2053	339
85922	ES150	ES150	1-5/8"	G	21.19	13.53	7.66	YES	NO	878	185
85923	ES177	ES161	1-5/8"	G	22.48	14.5	7.98	YES	YES	1940	221
85924	ES90	ES36	1-5/8"	G	20.41	12.96	7.46	YES	NO	1036	122
85925	ES90	ES90	1-5/8"	G	22.54	15.59	6.96	YES	NO	761	144
85926	ES90	ES90	1-5/8"	G	26.48	17.96	8.53	YES	YES	1387	279
85927	ES90	ES90	1-5/8"	G	24.74	15.38	9.36	YES	YES	1288	388
85928	ES90	ES90	1-5/8"	G	20.28	13.21	7.08	YES	NO	957	229
85929	ES90	ES90	1-5/8"	G	20.28	13.21	7.08	YES	NO	2214	267
85930	ES177	ES161	1-5/8"	G	17.86	12	5.86	YES	YES	1617	342

* Damping force, in pounds, to either extend or collapse the shock absorber at an average operating velocity. Fuerza de amortiguación en libras para extender o comprimir el amortiguador a una velocidad de operación promedio. La puissance d'amortissement en poids de l'amortisseur, soit comprimé, doit détendu, à une vitesse de fonctionnement moyenne.

† At bumper contact / Al contacto con el tope de goma / Au contact avec le butoir

‡ For GasSLX Series, forces are at the "Firm" (F) setting. / Para la serie GasSLX, las fuerzas están ajustadas en (F) "Firme". / Pour la série GasSLX, le réglage de la force est sur «Firme» (F).

SPECIFICATIONS BY PART NUMBER
ESPECIFICACIONES POR NÚMERO DE PARTE
SPÉCIFICATIONS PAR NUMÉRO DE PIÈCE

Fleetline	Mounting		Bore	External Diameter Illustration	Lengths			Dust Tube	Recoil Cutoff	Controls*	
	Upper	Lower			Extended	Collapsed	Stroke			Rebound	Compression
85931	ES177	ES161	1-5/8"	G	22.48	14.5	7.98	YES	YES	1435	220
85932	ES178	ES150	1-5/8"	G	21.23	13.62	7.61	YES	YES	1102	430
85933	ES175	ES175	1-5/8"	G	18.23	12.71	5.52	YES	YES	1089	383
85934	ES36	ES36	1-5/8"	G	17.73	12	5.73	YES	YES	3511	1063
85935	S21	ES36	1-5/8"	G	18.7	11.92	6.78	YES	NO	1054	419
85936	ES174	S43	1-5/8"	G	17.23	11.38	5.85	YES	YES	1479	337
85937	ES174	S43	1-5/8"	G	18.98	12.26	6.72	YES	YES	1479	337
85938	ES36	ES36	1-5/8"	G	16.06	10.78	5.28	YES	YES	1581	432
85939	ES36	ES36	1-5/8"	G	14.44	10.03	4.41	YES	YES	1719	420
85953	ES90	ES90	1-5/8"	G	26.13	15.86	10.27	YES	NO	2001	153
85954	ES90	ES36	1-5/8"	G	20.43	12.96	7.46	YES	NO	1812	148
85955	ES175	ES150	1-5/8"	G	21.25	13.66	7.59	YES	YES	1034	397
85956	ES183	ES184	1-5/8"	G	30.63	18.75	11.87	YES	YES	979	373
85957	ES90	ES90	1-5/8"	G	20.78	13.15	7.63	YES	NO	1583	138
85958	ES150	ES150	1-5/8"	G	22.96	14.55	8.41	YES	YES	1926	281
85959	ES150	ES150	1-5/8"	G	21.19	13.53	7.66	YES	YES	1021	123
85961	ES178	ES176	1-5/8"	G	22.83	14.17	8.66	YES	YES	2206	240
85962	ES178	ES176	1-5/8"	G	21.8	13.66	8.15	YES	YES	2206	240
85963	ES90	ES36	1-5/8"	G	25.49	18.68	6.81	YES	YES	1490	206
85964	ES90	ES36	1-5/8"	G	25.49	18.68	6.81	YES	YES	1981	205
85965	ES178	ES161	1-5/8"	G	24.24	15.15	9.09	YES	YES	2206	238
85966	ES178	ES161	1-5/8"	G	23.25	14.64	8.62	YES	YES	2206	238
85967	ES178	ES176	1-5/8"	G	23.93	14.86	9.07	YES	YES	2206	238
85968	EB3	EB3	1-5/8"	G	19.87	13.39	6.48	YES	YES	1069	227
85969	ES90	ES36	1-5/8"	G	18.38	11.93	6.45	YES	NO	1612	125
85970	ES188	S21	1-5/8"	G	27.19	16.4	10.78	YES	YES	1092	147
85971	ES36	ES36	1-5/8"	G	22.55	14.17	8.38	YES	NO	2315	451
85972	ES36	ES36	1-5/8"	G	30.78	18.26	12.52	YES	NO	1493	261
85974	ES36	ES36	1-5/8"	G	26.02	16.11	9.91	YES	YES	3087	230
85975	ES36	ES36	1-5/8"	G	24.24	15.15	9.09	YES	YES	1658	219
85976	ES36	ES36	1-5/8"	G	29.91	18.13	11.79	YES	YES	582	138
85977	ES36	S42	1-5/8"	G	26.2	15.91	10.29	YES	YES	582	138
85978	ES179	ES179	1-5/8"	G	29.91	18.13	11.79	YES	YES	582	138
85979	ES36	ES36	1-5/8"	G	31.17	18.66	12.52	YES	YES	582	138
85980	ES179	ES179	1-5/8"	G	31.17	18.66	12.52	YES	YES	582	138
85984	ES158	ES150	1-5/8"	G	25.44	15.96	9.48	YES	YES	2248	1168
85985	ES174	S43	1-5/8"	G	19.04	12.31	6.73	YES	YES	2068	723
85986	ES175	ES150	1-5/8"	G	21.25	13.66	7.59	YES	YES	1754	221
85988	S21	EB3	1-5/8"	G	23.84	14.87	8.97	YES	YES	1200	138
85989	ES174	ES136	1-5/8"	G	20.78	13.15	7.63	YES	NO	1812	351
85994	ES90	ES36	1-5/8"	G	21.21	13.4	7.81	YES	NO	1824	263
85995	ES90	ES36	1-5/8"	G	23.5	14.52	8.98	YES	NO	1830	173

* Damping force, in pounds, to either extend or collapse the shock absorber at an average operating velocity. Fuerza de amortiguación en libras para extender o comprimir el amortiguador a una velocidad de operación promedio. La puissance d'amortissement en poids de l'amortisseur, soit comprimé, doit détendu, à une vitesse de fonctionnement moyenne.

† At bumper contact / Al contacto con el tope de goma / Au contact avec le butoir

‡ For GasSLX Series, forces are at the "Firm" (F) setting. / Para la serie GasSLX, las fuerzas están ajustadas en (F) "Firme". / Pour la série GasSLX, le réglage de la force est sur «Firme» (F).

SPECIFICATIONS BY PART NUMBER
ESPECIFICACIONES POR NÚMERO DE PARTE
SPÉCIFICATIONS PAR NUMÉRO DE PIÈCE

Fleetline	Mounting		Bore	External Diameter Illustration	Lengths			Dust Tube	Recoil Cutoff	Controls*	
	Upper	Lower			Extended	Collapsed	Stroke			Rebound	Compression
85998	ES90	ES90	1-5/8"	G	22.83	14.17	8.66	YES	NO	1345	178
85999	ES90	ES90	1-5/8"	G	19.84	12.79	7.05	YES	NO	2214	259
86200	ES194	ES194	45 MM	D	14.24	10.45	3.79	YES	YES	4238	688
86201	ES193	ES193	45 MM	D	13.26	9.94	3.32	YES	YES	4238	688
86202	ES193	ES193	45 MM	D	14.52	10.43	4.09	YES	YES	4238	688
86203	ES193	ES193	45 MM	D	16.88	11.61	5.27	YES	YES	4238	910
87000	S21	EB3	2-1/16"	E	24.46	15.21	9.25	YES	YES	1332	300
87001	EB3	EB3	2-1/16"	E	20.76	13.76	7	YES	YES	1158	190
87002	EB3	EB3	2-1/16"	E	23.5	15.41	8.09	YES	YES	879	203
87003	EB3	EB3	2-1/16"	E	26.26	16.51	9.75	YES	YES	1332	395
87004	EB3	EB3	2-1/16"	E	26.76	16.76	10	YES	YES	1158	190
87006	EB3	EB3	2-1/16"	E	23.75	15.25	8.5	YES	YES	1158	272
87007	S21	S21	2-1/16"	E	15.65	10.4	5.25	YES	YES	879	253
87011	S21	S21	2-1/16"	E	23.65	14.4	9.25	YES	YES	1750	1050
87012	S21	S21	2-1/16"	E	23.65	14.4	9.25	YES	YES	650	364
87013	S21	S21	2-1/16"	E	23.65	14.4	9.25	YES	YES	1075	585
87015	ES173	ES173	45MM	E	15.51	11.18	4.33	YES	YES	4950	900
87016	S21	EB3	2-1/16"	E	21.17	13.91	7.26	YES	YES	1808	238
87017	ES160	ES160	2-1/16"	E	23.35	15.31	8.07	YES	YES	1876	220
87018	ES36	ES36	2-1/16"	E	17.36	11.71	5.65	YES	YES	2479	1000
87019	ES160	ES160	2-1/16"	E	24.84	15.85	8.9	YES	YES	2972	665
89401	EB2	EB2	1-5/8"	G	28.41	17.16	11.25	YES	NO	665‡	194
89402	EB2	EB2	1-5/8"	G	24.41	15.16	9.25	YES	NO	874‡	206
89403	EB2	EB2	1-5/8"	G	26.86	17.16	9.7	YES	YES	929‡	281
89405	ES36	ES36	1-5/8"	G	26.24	16.41	9.83	YES	YES	1009‡	249
89406	ES36	ES36	1-5/8"	G	24.74	15.66	9.08	YES	YES	658‡	125
89407	ES36	ES36	1-5/8"	G	21.62	14.04	7.58	YES	YES	652‡	218
89408	EB2	EB2	1-5/8"	G	19.67	12.79	6.88	YES	NO	536‡	201
89409	EB2	EB2	1-5/8"	G	26.36	16.41	9.95	YES	YES	567‡	165
89410	EB3	EB3	1-5/8"	G	26.33	16.42	9.91	YES	NO	1185‡	182
89411	ES90	ES90	1-5/8"	G	25.36	15.59	9.78	YES	YES	436‡	186
89412	EB3	EB3	1-5/8"	G	24.26	15.68	8.58	YES	YES	1155‡	169
89413	EB2	EB2	1-5/8"	G	20.91	13.41	7.5	YES	NO	536‡	201
89414	ES36	ES36	1-5/8"	G	29.62	18.04	11.58	YES	YES	1045‡	217
89415	EB2	EB2	1-5/8"	G	20.12	13.29	6.83	YES	YES	1155‡	514
89416	EB2	EB2	1-5/8"	G	28.62	17.54	11.08	YES	YES	1155‡	514
89417	ES136	S21	1-5/8"	G	22.93	14.18	8.75	YES	NO	1226‡	515
89418	S21	S21	1-5/8"	G	21.44	13.19	8.25	YES	NO	1266‡	515
89419	EB3	EB3	1-5/8"	G	18	12.55	5.45	YES	YES	1352‡	636
89420	EB3	EB3	1-5/8"	G	22.81	14.68	8.13	YES	NO	862‡	258
89422	EB3	EB3	1-5/8"	G	25.13	16.18	8.95	YES	YES	794‡	253
89423	S21	S21	1-5/8"	G	18.65	12.07	6.58	YES	YES	1352‡	573

* Damping force, in pounds, to either extend or collapse the shock absorber at an average operating velocity. Fuerza de amortiguación en libras para extender o comprimir el amortiguador a una velocidad de operación promedio. La puissance d'amortissement en poids de l'amortisseur, soit comprimé, doit détendu, à une vitesse de fonctionnement moyenne.

† At bumper contact / Al contacto con el tope de goma / Au contact avec le butoir

‡ For GasSLX Series, forces are at the "Firm" (F) setting. / Para la serie GasSLX, las fuerzas están ajustadas en (F) "Firme". / Pour la série GasSLX, le réglage de la force est sur «Firme» (F).

SPECIFICATIONS BY PART NUMBER
ESPECIFICACIONES POR NÚMERO DE PARTE
SPÉCIFICATIONS PAR NUMÉRO DE PIÈCE

Fleetline	Mounting		Bore	External Diameter Illustration	Lengths			Dust Tube	Recoil Cutoff	Controls*	
	Upper	Lower			Extended	Collapsed	Stroke			Rebound	Compression
89424	S21	EB3	1-5/8"	G	23.7	15	8.7	YES	YES	794‡	253
89425	EB3	EB3	1-5/8"	G	26.5	16.8	9.7	YES	YES	1352‡	167
89426	S21	ES36	1-5/8"	G	20.43	12.93	7.5	YES	NO	926‡	419
89427	S21	EB3	1-5/8"	G	27.2	17.5	9.7	YES	YES	794‡	253
89428	S21	ES150	1-5/8"	G	21.96	14.13	7.83	YES	YES	958‡	446
89429	EB3	EB3	1-5/8"	G	26.18	16.43	9.75	YES	NO	941‡	266
89430	ES36	ES36	1-5/8"	G	24.6	15.39	9.53	YES	YES	1462‡	279
89431	ES36	ES36	1-5/8"	G	22.41	14.16	8.25	YES	NO	751‡	211
89432	ES36	ES36	1-5/8"	G	23.41	14.66	8.75	YES	NO	1507‡	561
89434	EB2	EB2	1-5/8"	G	27.12	16.79	10.33	YES	YES	1155‡	514
89435	EB2	EB2	1-5/8"	G	24.86	15.66	9.2	YES	YES	1155‡	514
89436	ES36	ES36	1-5/8"	G	17.24	11.91	5.33	YES	YES	998‡	217
89437	ES36	ES36	1-5/8"	G	20.12	13.29	6.83	YES	YES	1155‡	514
89438	EB2	EB2	1-5/8"	G	23.17	14.54	8.63	YES	NO	583‡	103
89439	EB2	EB2	1-5/8"	G	25.67	15.79	9.88	YES	NO	518‡	103
89440	ES36	ES36	1-5/8"	G	23.86	15.16	8.7	YES	YES	1498‡	561
89441	S21	ES36	1-5/8"	G	20.14	13.06	7.08	YES	YES	761‡	126
89442	EB3	EB3	1-5/8"	G	24.55	15.55	9	YES	NO	1055‡	224
89443	ES158	ES159	1-5/8"	G	22.17	14.31	7.86	YES	YES	1206‡	466
89446	EB2	EB2	1-5/8"	G	28.36	17.41	10.95	YES	YES	702‡	204
89447	S21	S21	1-5/8"	G	23.65	14.57	9.08	YES	YES	702‡	241
89448	ES161	ES162	1-5/8"	G	24.62	15.54	9.08	YES	YES	782‡	323
89449	ES150	ES150	1-5/8"	G	23.09	14.71	8.38	YES	NO	1519‡	324
89450	ES161	ES162	1-5/8"	G	24.62	15.54	9.08	YES	YES	1282‡	193
89451	ES174	ES136	1-5/8"	G	30.36	18.41	11.95	YES	YES	645‡	172
89453	ES178	ES150	1-5/8"	G	21.1	13.78	7.32	YES	YES	860‡	435
89454	ES175	ES175	1-5/8"	G	18.23	12.78	5.45	YES	YES	938‡	388
89455	S21	S21	1-5/8"	G	26.28	15.92	10.36	YES	YES	791‡	276
89456	ES174	S43	1-5/8"	G	17.02	11.29	5.73	YES	YES	975‡	377
89457	ES90	ES36	1-5/8"	G	19.95	12.71	6.97	YES	NO	941‡	156
89458	ES177	ES161	1-5/8"	G	22.47	14.25	7.95	YES	YES	1575‡	222
89459	ES174	EB3	1-5/8"	G	25.62	15.86	9.78	YES	NO	1179‡	314
89460	ES174	ES136	1-5/8"	G	20.58	13.03	7.55	YES	NO	997‡	384
89461	ES160	ES160	1-5/8"	G	19.96	13.58	6.38	YES	YES	897‡	103
630811	0	0	1-3/16"		22.45	14.1	8.35	NO	NO		
632147	0	0	1-3/16"		22.45	14.1	8.35	NO	NO		
632155	ES36	ES36	1-3/16"		22.45	14.1	8.35	NO	NO		
646155	ES36	ES36	1-3/16"		22.45	14.1	8.35	YES	NO		
646177	ES36	ES36	1-3/16"		22.45	14.1	8.35	NO	NO		
665472	ES36	ES36	1-5/8"	G	25.14	15.61	9.53	NO	NO	925	977
665937	ES36	ES36	1-5/8"	G	22.91	16.09	6.82	YES	NO		
695406	S21	S21	2-1/16"	E	21.39	13.26	8.13	YES	YES	1854	274

* Damping force, in pounds, to either extend or collapse the shock absorber at an average operating velocity. Fuerza de amortiguación en libras para extender o comprimir el amortiguador a una velocidad de operación promedio. La puissance d'amortissement en poids de l'amortisseur, soit comprimé, doit détendu, à une vitesse de fonctionnement moyenne.

† At bumper contact / Al contacto con el tope de goma / Au contact avec le butoir

‡ For GasSLX Series, forces are at the "Firm" (F) setting. / Para la serie GasSLX, las fuerzas están ajustadas en (F) "Firme". / Pour la série GasSLX, le réglage de la force est sur «Firme» (F).

SPECIFICATIONS BY PART NUMBER
ESPECIFICACIONES POR NÚMERO DE PARTE
SPÉCIFICATIONS PAR NUMÉRO DE PIÈCE

Fleetline	Mounting		Bore	External Diameter Illustration	Lengths			Dust Tube	Recoil Cutoff	Controls*	
	Upper	Lower			Extended	Collapsed	Stroke			Rebound	Compression
G63183	EB4	EB4	1-3/8"		20.89	13.11	7.78	YES	NO		
G63299	EB1	EB1	1-3/8"		18.08	11.55	6.53	YES	NO	396	109
G63306	ES2	ES24	1-3/8"		19.86	12.58	7.28	YES	NO		
G63347	ES3	ES24	1-3/8"		18.08	11.55	6.53	YES	NO		
G63350	S1	ES25	1-3/8"		18.83	11.8	7.03	YES	NO		
G63355	EB7	ES24	1-3/8"		15	9.97	5.03	YES	NO		
G63357	ES24	ES24	1-3/8"		15	9.97	5.03	YES	NO		
G63386	S36	ES25	1-3/8"		17.19	11.16	6.03	NO	YES		
G63387	S1	ES25	1-3/8"		23.33	14.05	9.28	YES	NO		
G63396	S10	ES25	1-3/8"		16.55	10.77	5.78	YES	NO		
G63398	S1	S1	1-3/8"		20.52	12.24	8.28	YES	NO		
G63403	ES82	ES82	1-3/8"		24.58	14.8	9.78	YES	NO		
G63405	EB1	EB1	1-3/8"		20	12.47	7.53	YES	NO	572	115
G63406	EB1	ES83	1-3/8"		23	13.97	9.03	YES	NO		
G63409	EB1	ES83	1-3/8"		21.58	13.3	8.28	YES	NO		
G63419	EB1	EB1	1-3/8"		24.08	14.55	9.53	YES	NO		
G63432	S1	EB2	1-3/8"		21.21	12.93	8.28	YES	NO		
G63440	EB1	EB1	1-3/8"		26.33	15.55	10.78	NO	NO		
G63455	ES8	ES83	1-3/8"		23	13.97	9.03	YES	NO		
G63461	EB1	ES83	1-3/8"		25.5	15.22	10.28	YES	NO		
G63484	S4	EB1	1-3/8"		20.05	12.52	7.53	YES	NO		
G63500	S28	ES25	1-3/8"		15.09	10.06	5.03	NO	YES		
G63511	S1	ES25	1-3/8"		22.55	13.52	9.03	YES	NO		
G63524	EB1	ES83	1-3/8"		27.08	16.05	11.03	YES	NO		
G63525	EB1	ES83	1-3/8"		23.08	14.05	9.03	YES	NO		
G63605	EB2	ES27	1-3/8"		24.24	14.71	9.53	YES	NO		
G63607	BP33	ES83	1-3/8"		25.58	15.3	10.28	YES	NO		
G63608	S36	EB1	1-3/8"		14.58	9.81	4.78	YES	YES		
G63610	S1	EB1	1-3/8"		21.55	13.27	8.28	YES	NO		
G63614	S36	EB1	1-3/8"		15.12	10.09	5.03	NO	YES		
G63622	S36	EB1	1-3/8"		15.42	10.39	5.03	YES	YES		
G63623	S36	ES83	1-3/8"		22.67	14.39	8.28	YES	YES		
G63624	S36	ES83	1-3/8"		20.17	12.64	7.53	YES	YES		
G63625	EB7	ES36	1-3/8"		22.48	13.96	8.53	YES	NO		
G63676	ES69	ES69	1-3/8"		15.58	10.55	5.03	YES	YES		
G63678	S36	BP7	1-3/8"		18.09	13.56	4.53	YES	NO		
G63679	BP8	ES83	1-3/8"		25	14.97	10.03	YES	NO		
G63714	S6	BP7	1-3/8"		15.54	10.01	5.53	YES	NO		
G63716	S12	ES26	1-3/8"		15.54	10.01	5.53	YES	NO		
G63772	S6	BP35	1-3/8"		13.83	9.55	4.28	YES	YES		
G63773	EB1	ES83	1-3/8"		23.08	14.05	9.03	YES	NO		
G63775	EB1	ES83	1-3/8"		27.08	16.05	11.03	YES	NO		

* Damping force, in pounds, to either extend or collapse the shock absorber at an average operating velocity. Fuerza de amortiguación en libras para extender o comprimir el amortiguador a una velocidad de operación promedio. La puissance d'amortissement en poids de l'amortisseur, soit comprimé, doit détendu, à une vitesse de fonctionnement moyenne.

† At bumper contact / Al contacto con el tope de goma / Au contact avec le butoir

‡ For GasSLX Series, forces are at the "Firm" (F) setting. / Para la serie GasSLX, las fuerzas están ajustadas en (F) "Firme". / Pour la série GasSLX, le réglage de la force est sur «Firme» (F).

SPECIFICATIONS BY PART NUMBER
ESPECIFICACIONES POR NÚMERO DE PARTE
SPÉCIFICATIONS PAR NUMÉRO DE PIÈCE

Fleetline	Mounting		Bore	External Diameter Illustration	Lengths			Dust Tube	Recoil Cutoff	Controls*	
	Upper	Lower			Extended	Collapsed	Stroke			Rebound	Compression
G63778	S12	ES25	1-3/8"		24.55	14.52	10.03	YES	NO		
G63808	EB1	ES83	1-3/8"		28.86	17.08	11.78	YES	NO		
G63809	EB1	ES83	1-3/8"		23	13.97	9.03	YES	NO		
G63810	EB1	ES83	1-3/8"		31.51	18.48	13.03	YES	NO		
G63811	EB1	ES83	1-3/8"		25.5	15.22	10.28	YES	NO		
G63837	BP8	ES83	1-3/8"		28.23	17.95	10.28				
G63866	ES34	ES34	1-3/8"		22.81	14.12	8.69				
G63929	S36	EB1	1-3/8"		14.72	9.71	5.01	YES	YES		
G63969	412847	ES34	1-3/8"		20.75	13.31	7.44				

* Damping force, in pounds, to either extend or collapse the shock absorber at an average operating velocity. Fuerza de amortiguación en libras para extender o comprimir el amortiguador a una velocidad de operación promedio. La puissance d'amortissement en poids de l'amortisseur, soit comprimé, doit détendu, à une vitesse de fonctionnement moyenne.

† At bumper contact / Al contacto con el tope de goma / Au contact avec le butoir

‡ For GasSLX Series, forces are at the "Firm" (F) setting. / Para la serie GasSLX, las fuerzas están ajustadas en (F) "Firme". / Pour la série GasSLX, le réglage de la force est sur «Firme» (F).

MOUNTING ACCESSORY PACKAGES AND COMPONENT PARTS
KITS DE ACCESORIOS Y COMPONENTES
ENSEMBLES D'ACCESSOIRES DE MONTURES ET DE PIÈCES DÉTACHÉES

140126	401383	2	Retainer (washer) / Seguro (arandela) / Arrêt (rondelle)	3/8 in. I.D. x 1-1/2 in. O.D. x .093 in. thick
	402263	2	Bushing / Buje / Bague	7/8" centering lip for 3/8" O.D. stud
	401006	1	Hex nut / Tuerca hexagonal / Écrou hexagonal	3/8" x 24 UNF thread
140149	401011	4	Bushing / Buje / Bague	EB2 style - for 1-3/4" O.D. eye ring - 3/4" diam. Stud
140169	401011	2	Bushing / Buje / Bague	EB2 style - for 1-3/4" O.D. eye ring - 3/4" diam. Stud
140455	401006	1	Hex nut / Tuerca hexagonal / Écrou hexagonal	3/8" x 24 UNF thread
	401008	2	Retainer (washer) / Seguro (arandela) / Arrêt (rondelle)	3/8 in. I.D. x 1-1/4 in. O.D. x .075 in. thick
	403489	2	Bushing / Buje / Bague	5/8" centering lip for 3/8" O.D. stud
140524	401006	1	Hex nut / Tuerca hexagonal / Écrou hexagonal	3/8" x 24 UNF thread
	401376	2	Retainer (washer) / Seguro (arandela) / Arrêt (rondelle)	3/8 in. I.D. x 1-3/8 in. O.D. x .089 in. thick
	402294	2	Bushing / Buje / Bague	5/8" lip for 3/8" dia. stud-5/8" or 7/8" holes
140702	401174	1	Hex nut / Tuerca hexagonal / Écrou hexagonal	5/8" x 18 thread
	401184	1	Lock washer / Arandela de seguridad / Rondelle-frein	7/16" Lock washer
	401193	1	Lock washer / Arandela de seguridad / Rondelle-frein	5/8" I.D. (thin)
	402844	1	Hex nut / Tuerca hexagonal / Écrou hexagonal	7/16" x 20 UNF Thread
	403878	1	Washer / Arandela / Rondelle	0.453" I.D. x 1.25" O.D. x .075" thick
	404782	1	Stud / Perno / Goujon	5/8" x 18 and 7/16" x 20
140719	402653-001	2	Lock washer / Arandela de seguridad / Rondelle-frein	5/16" I.D. (med.)
	403870-001	2	Bolt / Tornillo / Boulon	Hex Head 5/16" x 18 x 3/4 in. long
	403871-001	2	Hex nut / Tuerca hexagonal / Écrou hexagonal	5/16" x 18 thread
140780	401006	1	Hex nut / Tuerca hexagonal / Écrou hexagonal	3/8" x 24 UNF thread
	402943	1	Retainer (washer) / Seguro (arandela) / Arrêt (rondelle)	0.457" I.D. x 1.68" O.D. x .120" thick
	403298	1	Retainer (washer) / Seguro (arandela) / Arrêt (rondelle)	0.390" I.D. x 1.68" O.D. x .120" thick
	403299	2	Bushing / Buje / Bague	7/8" centering lip for 7/16" O.D. stud
140884	401267	1	Retainer (washer) / Seguro (arandela) / Arrêt (rondelle)	5/8" I.D. x 1-1/4" O.D. x .075" thick
	402662	1	Spacer / Espaciador / Entretoise	5/8" I.D. x 1-1/4" O.D. x 1/4" thick
	412016	1	Extn nut / Tuerca ext. / Écrou ext.	7/16" x 20 UNF Thread
	427030	1	Instruction sheet / Hoja de instr. / Feuillet d'instr.	
140885	401267	1	Retainer (washer) / Seguro (arandela) / Arrêt (rondelle)	5/8" I.D. x 1-1/4" O.D. x .075" thick
	402662	1	Spacer / Espaciador / Entretoise	5/8" I.D. x 1-1/4" O.D. x 1/4" thick
	403189	2	Spacer / Espaciador / Entretoise	1/2" I.D. x 1-1/4" O.D.
	411012	2	Sleeve / Camisa / Manchon	13 mm I.D. x 5/8 in. O.D. x 1-5/16 in. long
	412016	1	Extn nut / Tuerca ext. / Écrou ext.	7/16" x 20 UNF Thread
	427031	1	Instruction sheet / Hoja de instr. / Feuillet d'instr.	
141041	401006	1	Hex nut / Tuerca hexagonal / Écrou hexagonal	3/8" x 24 UNF thread
	401376	2	Retainer (washer) / Seguro (arandela) / Arrêt (rondelle)	3/8 in. I.D. x 1-3/8 in. O.D. x .089 in. thick
	404652	2	Bushing / Buje / Bague	Used with 5/8" dia. hole or 7/8" dia. Hole
141083	401193	1	Lock washer / Arandela de seguridad / Rondelle-frein	5/8" I.D. (thin)
	404451	1	Hex nut / Tuerca hexagonal / Écrou hexagonal	16 x 1.5 metric thread
	404452	2	Retainer (washer) / Seguro (arandela) / Arrêt (rondelle)	5/8" I.D. x 2-3/4" O.D. x .180" thick
	404453	1	Sleeve / Camisa / Manchon	16 mm I.D. x 1-3/16" O.D. x 1-1/2" long
	404454	2	Bushing / Buje / Bague	1-3/16" centering lip for 13/16" O.D. stud
141108	401174	2	Hex nut / Tuerca hexagonal / Écrou hexagonal	5/8" x 18 thread
	405360	4	Retainer (washer) / Seguro (arandela) / Arrêt (rondelle)	5/8" I.D. x 2-3/16" O.D. x .120" thick
	405361-000	4	Bushing / Buje / Bague	1" centering lip for 5/8" O.D. stud (1.00" thick)
141138	401006	2	Hex nut / Tuerca hexagonal / Écrou hexagonal	3/8" x 24 UNF thread
	403489	4	Bushing / Buje / Bague	5/8" centering lip for 3/8" O.D. stud
	403575	4	Retainer (washer) / Seguro (arandela) / Arrêt (rondelle)	25/64" I.D. x 1-1/4" O.D. x .12" thick
	404949	4	Washer / Arandela / Rondelle	1/2" I.D. x 1-1/2" O.D. x .04" thick

MOUNTING ACCESSORY PACKAGES AND COMPONENT PARTS
KITS DE ACCESORIOS Y COMPONENTES
ENSEMBLES D'ACCESSOIRES DE MONTURES ET DE PIÈCES DÉTACHÉES

141247	401174	1	Hex nut / Tuerca hexagonal / Écrou hexagonal	5/8" x 18 thread
	401754	2	Bushing / Buje / Bague	EB3 - style for 2.39 in. O.D. eye ring - 1" diam. Stud
	405360	2	Retainer (washer) / Seguro (arandela) / Arrêt (rondelle)	5/8" I.D. x 2-3/16" O.D. x .120" thick
	405361	2	Bushing / Buje / Bague	1" centering lip for 5/8" O.D. stud
141349	401006	1	Hex nut / Tuerca hexagonal / Écrou hexagonal	3/8" x 24 UNF thread
	401007	1	Pal nut / Tuerca de cierre / Écrou Pal	3/8" x 24 UNF thread
	401376	2	Retainer (washer) / Seguro (arandela) / Arrêt (rondelle)	3/8 in. I.D. x 1-3/8 in. O.D. x .089 in. thick
	404652	2	Bushing / Buje / Bague	Used with 5/8" dia. hole or 7/8" dia. Hole
	429680-030	1	Instruction sheet / Hoja de instr. / Feuillet d'instr.	
141353	401006	1	Hex nut / Tuerca hexagonal / Écrou hexagonal	3/8" x 24 UNF thread
	401007	1	Jam nut / Contratuerca / Contre-Écrou	3/8" x 24 UNF thread
	401383	2	Retainer (washer) / Seguro (arandela) / Arrêt (rondelle)	3/8 in. I.D. x 1-1/2 in. O.D. x .093 in. thick
	402263	2	Bushing / Buje / Bague	7/8" centering lip for 3/8" O.D. stud
141665	401006	1	Hex nut / Tuerca hexagonal / Écrou hexagonal	3/8" x 24 UNF thread
	402943	1	Retainer (washer) / Seguro (arandela) / Arrêt (rondelle)	0.457" I.D. x 1.68" O.D. x .120" thick
	403298	1	Retainer (washer) / Seguro (arandela) / Arrêt (rondelle)	0.390" I.D. x 1.68" O.D. x .120" thick
	404959	2	Bushing / Buje / Bague	3/4" centering lip for 7/16" O.D. stud
	411520	1	Jam nut / Contratuerca / Contre-Écrou	3/8" x 24 UNF thread
142095	411165	1	Lock nut / Contratuerca / Contre-Écrou	12 x 1.25 metric thread
	411447	2	Retainer (washer) / Seguro (arandela) / Arrêt (rondelle)	9/16" I.D. x 1-3/4" O.D. x .087" thick
	412103	1	Retainer (washer) / Seguro (arandela) / Arrêt (rondelle)	9/16" I.D. x 1-3/4" O.D. x 1/4" thick
	412116	2	Bushing / Buje / Bague	Flat bushing for 9/16" O.D. Stud
142389	404287	2	Retainer (washer) / Seguro (arandela) / Arrêt (rondelle)	0.453" I.D. x 1.50" O.D. x 0.090" thick
	404947	2	Bushing / Buje / Bague	For 3/8" O.D. stud- no centering lip
	411497	1	Lock nut / Contratuerca / Contre-Écrou	10 x 1.25 metric thread
142617	401006	1	Hex nut / Tuerca hexagonal / Écrou hexagonal	3/8" x 24 UNF thread
	402943	1	Retainer (washer) / Seguro (arandela) / Arrêt (rondelle)	0.457" I.D. x 1.68" O.D. x .120" thick
	403298	1	Retainer (washer) / Seguro (arandela) / Arrêt (rondelle)	0.390" I.D. x 1.68" O.D. x .120" thick
	412661	2	Bushing / Buje / Bague	0.790" centering lip for 7/16" O.D. stud
142700	401006	1	Hex nut / Tuerca hexagonal / Écrou hexagonal	3/8" x 24 UNF thread
	402943	1	Retainer (washer) / Seguro (arandela) / Arrêt (rondelle)	0.457" I.D. x 1.68" O.D. x .120" thick
	403298	1	Retainer (washer) / Seguro (arandela) / Arrêt (rondelle)	0.390" I.D. x 1.68" O.D. x .120" thick
	404959	2	Bushing / Buje / Bague	3/4" centering lip for 7/16" O.D. stud
	411520	1	Jam nut / Contratuerca / Contre-Écrou	3/8" x 24 UNF thread
	412682	1	Sleeve / Camisa / Manchon	0.479" I.D. x 0.548" O.D. x 1.48" long
	429680-008	1	Instruction sheet / Hoja de instr. / Feuillet d'instr.	
142731	411165	1	Lock nut / Contratuerca / Contre-Écrou	12 x 1.25 metric thread
	411447	1	Retainer (washer) / Seguro (arandela) / Arrêt (rondelle)	9/16" I.D. x 1-3/4" O.D. x .087" thick
	412554	1	Retainer (washer) / Seguro (arandela) / Arrêt (rondelle)	0.485" O.D. x 1.76" O.D. x .089" thick
	412675	2	Bushing / Buje / Bague	0.950" centering lip for 9/16" O.D. stud
142998	404452	2	Retainer (washer) / Seguro (arandela) / Arrêt (rondelle)	5/8" I.D. x 2-3/4" O.D. x .180" thick
	404454	2	Bushing / Buje / Bague	1-3/16" centering lip for 13/16" O.D. stud
	405862	1	Self locking nut / Tuerca de seguridad / Écrou indesserrable	5/8" x 18 thread
143146	411165	1	Lock nut / Contratuerca / Contre-Écrou	12 x 1.25 metric thread
	411447	2	Retainer (washer) / Seguro (arandela) / Arrêt (rondelle)	9/16" I.D. x 1-3/4" O.D. x .087" thick
	412675	2	Bushing / Buje / Bague	0.950" centering lip for 9/16" O.D. stud
145054	401174	1	Hex nut / Tuerca hexagonal / Écrou hexagonal	5/8 in. -18 thread
	401175	1	Lock washer / Arandela de seguridad / Rondelle-frein	
	405360	2	Retainer (washer) / Seguro (arandela) / Arrêt (rondelle)	5/8" I.D. x 2-3/16" O.D. x .120" thick
	405361-000	2	Bushing / Buje / Bague	1" centering lip for 5/8" O.D. stud (1.00" thick)

MOUNTING ACCESSORY PACKAGES AND COMPONENT PARTS
KITS DE ACCESORIOS Y COMPONENTES
ENSEMBLES D'ACCESSOIRES DE MONTURES ET DE PIÈCES DÉTACHÉES

145080	401011	2	Bushing / Buje / Bague	EB2 style - for 1-3/4" O.D. eye ring - 3/4" diam. Stud
	401429	1	Retainer (washer) / Seguro (arandela) / Arrêt (rondelle)	1/2" I.D. x 1-5/8" O.D. x .090" thick
	401430	1	Retainer (washer) / Seguro (arandela) / Arrêt (rondelle)	3/4" I.D. x 1-5/8" O.D. x .090" thick
145089-000	405360	2	Retainer (washer) / Seguro (arandela) / Arrêt (rondelle)	5/8" I.D. x 2-3/16" O.D. x .120" thick
	405361-000	2	Bushing / Buje / Bague	1" centering lip for 5/8" O.D. stud (1.00" thick)
	405862	1	Self locking nut / Tuerca de seguridad / Écrou indesserrable	5/8" x 18 thread
145089-200	405360	2	Retainer (washer) / Seguro (arandela) / Arrêt (rondelle)	5/8" I.D. x 2-3/16" O.D. x .120" thick
	405361-100	2	Bushing / Buje / Bague	1" centering lip for 5/8" O.D. stud (0.75" thick)
	415196-001	1	Nylon lock nut / Contratuerca / Contre-Écrou	5/8" x 18 thread
145090	405643	1	Sleeve / Camisa / Manchon	0.645" I.D x 0.810" O.D. x 2.00" long
	405859	2	Bushing / Buje / Bague	0.815" I.D. x 2.35" O.D x 1.05" thick with 1.15" centering lip
	405860	2	Retainer (washer) / Seguro (arandela) / Arrêt (rondelle)	0.650" I.D. x 2.75" O.D. x .180" thick
	405862	1	Self locking nut / Tuerca de seguridad / Écrou indesserrable	5/8" x 18 thread
	424276	1	Instruction sheet / Hoja de instr. / Feuillet d'instr.	
145093	401750	2	Retainer (washer) / Seguro (arandela) / Arrêt (rondelle)	3/4" I.D. x 2-3/8" O.D. x .105" thick
	401752	2	Retainer (washer) / Seguro (arandela) / Arrêt (rondelle)	1" I.D. x 2-3/8" O.D. x .105" thick
	401754	4	Bushing / Buje / Bague	EB3 - style for 2.39 in. O.D. eye ring - 1" diam. Stud
145099	401174	1	Hex nut / Tuerca hexagonal / Écrou hexagonal	5/8" x 18 thread
	401175	1	Lock washer / Arandela de seguridad / Rondelle-frein	
	401754	2	Bushing / Buje / Bague	EB3 - style for 2.39 in. O.D. eye ring - 1" diam. Stud
	405360	2	Retainer (washer) / Seguro (arandela) / Arrêt (rondelle)	5/8" I.D. x 2-3/16" O.D. x .120" thick
	405361-000	2	Bushing / Buje / Bague	1" centering lip for 5/8" O.D. stud (1.00" thick)
	424274	1	Instruction sheet / Hoja de instr. / Feuillet d'instr.	
145116	401750	1	Retainer (washer) / Seguro (arandela) / Arrêt (rondelle)	3/4" I.D. x 2-3/8" O.D. x .105" thick
	401752	1	Retainer (washer) / Seguro (arandela) / Arrêt (rondelle)	1" I.D. x 2-3/8" O.D. x .105" thick
	415169	2	Bushing / Buje / Bague (Durometer 80)	EB3 - style for 2.39 in. O.D. eye ring - 1" diam. Stud
145126	401750	2	Retainer (washer) / Seguro (arandela) / Arrêt (rondelle)	3/4" I.D. x 2-3/8" O.D. x .105" thick
	401754	2	Bushing / Buje / Bague	EB3 - style for 2.39 in. O.D. eye ring - 1" diam. Stud
	403752	1	Sleeve / Camisa / Manchon	3/4" I.D. x 15/16" O.D. x 1-3/4" long
	415277	1	Spacer / Espaciador / Entretoise	1-3/16" I.D. x 1-1/4" O.D. x .200" thick
	424281	1	Instruction sheet / Hoja de instr. / Feuillet d'instr.	
145128	405360	2	Retainer (washer) / Seguro (arandela) / Arrêt (rondelle)	5/8" I.D. x 2-3/16" O.D. x .120" thick
	405361-000	2	Bushing / Buje / Bague	1" centering lip for 5/8" O.D. stud (1.00" thick)
	415196-001	1	Nylon lock nut / Contratuerca / Contre-Écrou	5/8" x 18 thread
145143	415305-001	2	Rubber spacer / Espaciador de goma / Entretoise de caout.	0.910" I.D. x 1.58" O.D. x 0.427" long
	424284	1	Instruction sheet / Hoja de instr. / Feuillet d'instr.	
145144	415305-000	2	Rubber spacer / Espaciador de goma / Entretoise de caout.	0.910" I.D. x 1.58" O.D. x 1.1" long
	424284	1	Instruction sheet / Hoja de instr. / Feuillet d'instr.	
145148	401750	1	Retainer (washer) / Seguro (arandela) / Arrêt (rondelle)	3/4" I.D. x 2-3/8" O.D. x .105" thick
	401752	1	Retainer (washer) / Seguro (arandela) / Arrêt (rondelle)	1" I.D. x 2-3/8" O.D. x .105" thick
145176	405361-000	2	Bushing / Buje / Bague	1" centering lip for 5/8" O.D. stud (1.00" thick)
	405360	1	Retainer (washer) / Seguro (arandela) / Arrêt (rondelle)	5/8" I.D. x 2-3/16" O.D. x .120" thick
	415196-001	1	Nylon lock nut / Contratuerca / Contre-Écrou	5/8" x 18 thread
	404452	1	Retainer (washer) / Seguro (arandela) / Arrêt (rondelle)	5/8" I.D. x 2-3/8" O.D. x .180" thick
401011		1	Bushing / Buje / Bague	EB2 style - for 1-3/4" O.D. eye ring - 3/4" diam. Stud - Replaced by TR0027
401754		1	Bushing / Buje / Bague	EB3 - style for 2.39 in. O.D. eye ring - 1" diam. Stud
404702		1	Bushing / Buje / Bague	EB1 style - 1 pc Spool shaped bushing (5/8" I.D.)
406422		1	Retainer (washer) / Seguro (arandela) / Arrêt (rondelle)	22 mm I.D. x 60.2 mm O.D. x 2.7 mm thick
415010-802		1	Sleeve / Camisa / Manchon	22 mm I.D. x 1.00" O.D. x 1-3/4" long
TR0027		1	Bushing / Buje / Bague	EB2 style - for 1-3/4" O.D. eye ring - 3/4" diam. Stud - (Replaces 401011)

MOUNTING ACCESSORY PACKAGES - BUYER'S GUIDE
KITS DE ACCESORIOS – GUÍA DEL COMPRADOR
ENSEMBLE D'ACCESSOIRES POUR LA FIXATION - GUIDE DE L'ACHETEUR

Kit #	Gabriel #
140126	83027
	G63350
	G63387
140149	83200
	83216
	83219
	83308
	83309
	83312
	83314
	85023
	85024
	85046
	85047
	89402
140169	85025
	85031
	G63432
	G63605
140455	83003
	83005
	83014
	83015
	83400
140524	83161
	G63484
140702	83007
	83303
	83304
	G63355
	G63625
140719	G63607
	G63679
140780	83018
	83019
	83041
	83045
	83050
	83058
	83105
	83114
	83162
	83177

Kit #	Gabriel #
140780 Cont.	G63386
	G63396
	G63414
	G63500
	G63608
	G63614
	G63624
	G63929
140884	G63405
140885	G63299
141041	83515
	83518
141083	83301
	83317
	83318
	83613
141108	85310
	89447
141138	G63398
141247	85311
	85312
	85703
	85710
	85711
141349	G63432
141353	G63511
141665	G63772
142095	83178
142389	G63610
142617	G63622
	G63623
142700	G63778
142731	G63714
	G63716
142998	83456
143146	G63969
145054	83103
	83134
	83136
	83635
	85009
	85025
	85026

Kit #	Gabriel #
145054 Cont.	85027
	85071
	85080
	85085
	85092
	85124
	85126
	85318
	85324
	85330
	85336
	85342
	85379
	85701
	85731
	85900
	85902
	85921
145075	85723
145080	83107
	85012
	85054
	85055
	85062
	85063
145089-000	83102
	83120
	83154
	85069
	85122
	85319
	85340
	85341
	85343
	85733
	85970
145089-200	85936
	85937
	85985
145090	695406
	85081
	85123
	85316

MOUNTING ACCESSORY PACKAGES - BUYER'S GUIDE
KITS DE ACCESORIOS – GUÍA DEL COMPRADOR
ENSEMBLE D'ACCESSOIRES POUR LA FIXATION - GUIDE DE L'ACHETEUR

Kit #	Gabriel #
145090 Cont.	85346
	85347
	85351
	85380
	85705
	85706
	85707
	85708
	85709
	85722
	85740
	85745
	85746
	85935
	87016
145093	85714
	85715
	85716
	85717
	85718
	85719
145099	83353
	85033
	85988
145116	83162
	85732
	87016
145126	85053
145128	83062
	83109
	83110
	83111
	83112
	83138
	83142
	83143
	85065
	85083
	85332
	85333
	85977
145143	83120
145144	85065

Kit #	Gabriel #
145148	83140
	83141
145176	85727
	85728
	85729
401011	83404
401754	83214
	83215
	83217
	83225
	83362
	85001
	85004
	85007
	85040
	85042
	85070
	85300
	85301
	85302
	85303
	85304
	85305
	85307
	85308
	85313
	85314
	85315
	85320
	85322
	85327
	85329
	85334
	85339
	85343
	85376
	85380
	85700
	85702
	85703
	85704
	85710
	85711

Kit #	Gabriel #
401754 Cont.	85712
	85713
	85720
	85729
	85730
	85731
	85734
	85735
	85736
	85740
	85901
	85905
	85912
	85913
	85968
404702	83001
	83006
	83007
	83011
	83012
	83038
	83047
	83117
	83161
	83177
	83401
406422	83162
415010-802	83140
	83141
	83162
TR0027	83159
	83515
	83518
	83519
	85031



Fleetline® GasSLX® Interchange

Intercambio
Échange

Fleetline	GasSLX
83122	89406
83123	89405
83124	89407
83126	89430
83203	89436
83207	89407
83209	89414
83309	89446
83312	89409
83389	89436
83456	89447
85000	89436
85001	89410
85003	89411
85005	89430
85007	89412
85012	89413
85013	89414
85023	89415
85024	89416
85026	89417
85027	89418
85030	89440
85033	89427
85036	89405
85046	89434
85047	89435
85053	89442
85054	89438
85055	89439

Fleetline	GasSLX
85058	89431
85061	89450
85062	89408
85066	89448
85067	89451
85069	89455
85070	89459
85084	89460
85300	89419
85302	89420
85303	89422
85308	89422
85310	89423
85311	89424
85314	89425
85316	89426
85319	89428
85320	89429
85323	89436
85705	89447
85724	89443
85906	89407
85916	89430
85918	89449
85923	89458
85924	89457
85931	89458
85932	89453
85933	89454
85936	89456



IMPORTANT NOTE: Interchange must only be used for FLEETLINE to GAS SLX upgrade. Interchange is **NOT REVERSABLE**.

NOTA IMPORTANTE: El intercambio se debe utilizar solamente de FLEETLINE a GAS SLX mejorado. El intercambio **NO ES REVERSIBLE**.

REMARQUE IMPORTANTE: L'échange ne peut se faire que pour le surclassement du FLEETLINE au GAS SLX. L'échange **N'EST PAS REVERSIBLE**.





WE'LL HELP YOU GET IT RIGHT

THE HOLLAND ELI-te™ FIFTH WHEEL COUPLING ASSISTANT



ELI-te™ Coupling Assistant
can be spec'd with
the FW35 Series

SAF-HOLLAND – the world's leader in fifth wheel innovation, introduces the ELI-te™ fifth wheel coupling assistant.

Designed for Safety Minded Fleets

- A failed coupling attempt triggers flashing red warning lights alerting drivers to hazards before they happen.
- A successful coupling turns on high-intensity inspection lamps in the fifth wheel throat making lock inspection easier and more reliable.

The HOLLAND ELI-te™ fifth wheel coupling assistant will help drivers GET IT RIGHT.

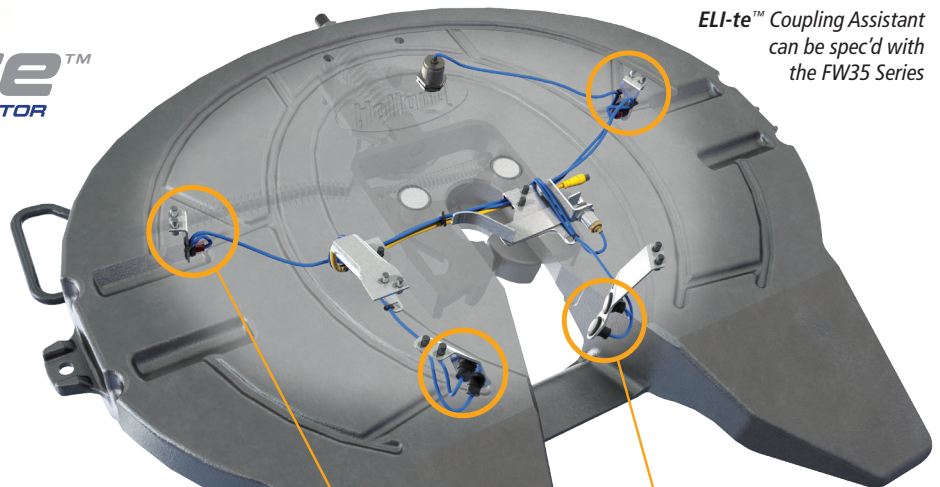

FAILED MODE
Red Flashing Warning Lights



SUCCESS MODE
Bright Lock Inspection Lights

www.safholland.us 888-396-6501

WATCH THE
ELI-te™ VIDEO



FRONT_{TO}BACK

SAF-HOLLAND ORIGINAL PARTS



HOLLAND has been the go-to brand for pintle hooks, drawbars and couplers for over 70 years. Be sure your coupling connection is reliable and safe...always spec HOLLAND.

Holland

COUPLING PRODUCTS

PINTLE HOOKS & DRAWBARS



PH-410

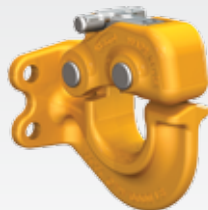

PH-10RP41



PH-30SA41



PH-30RP41



DB-610-30



DB-1249-49



DB-1245



DB-060FQ1

safholland.us
Call 800.876.3929

SAF-Holland
ORIGINAL PARTS™

safholland.com
Canada 519.537.3494
Mexico 52.55.5816.2230

SAF   

ORIGINAL SERVICE PARTS TO KEEP YOU ROLLING



Engineering Your Road to Success

SAF-HOLLAND is a leading supplier of highly efficient components, systems and service programs in the global commercial vehicle industry. Our three core product brands are recognized for delivering innovative solutions that optimize fleet operations in every corner of the world.



**TRAILER AXLES AND
SUSPENSION SYSTEMS**



**COUPLING AND LIFTING
TECHNOLOGIES**



**SUSPENSIONS FOR
TRUCKS AND BUSES**

With our team of over 3,000 employees and a worldwide network of over 9,000 service partners, we serve our fleet customers with know-how and passion, and always focused on one target: **Engineering your road to success.** Anywhere in the world. Under any conditions. 365 days a year.

HIGHLY EFFICIENT COMPONENTS AND SYSTEMS FOR TRUCKS AND TRAILERS



ORIGINAL SERVICE PARTS DESIGNED TO KEEP YOU ROLLING

safholland.com

SAF-HOLLAND, Inc.
888.396.6501 Fax 800.356.3929

SAF-HOLLAND Canada Limited
519.537.3494 Fax 800.565.7753

Western Canada 604.574.7491 Fax 604.574.0244